



# LABORATORY IDENTIFICATION

---

**Labels, printers & software for laboratories**

# About **BRADY**



**Once you have worked with BRADY, our name will stick with you, (just like our labels) because BRADY is one of the world's leading labelling and identification specialists.**

## **Innovative**

At BRADY we continue to improve. We have many customers from all industries, and we strive to be ahead of their needs by continuing to invest in research for even more performant solutions. By developing more user-friendly and efficient concepts, we give our thousands of customers the best in the market.

## **Strength**

At BRADY, we believe our biggest strength is the wide range of identification and safety solutions we can offer our customers, whether it's labelling the smallest component or complete signage for an entire warehouse. We're also proud to offer many products and services - from printers, scanners and software to service contracts and on-site training - that compliment any identification job. And don't forget, our wide network of expert distributors can always offer you a tailor-made solution to meet your specific requirements.

## **Trust**

For over a hundred years, BRADY has been connected with quality, trust and stability. We demand the best for your products and services, because we know, better than anyone, the importance of good and reliable identification. Identification looks like a small detail, but every professional knows that this kind of detail is crucial to any business.

## **Inform**

We also have specialised dealers in your region, who can answer all your identification, safety and labelling questions, specific to your activity. They will be happy to provide you with all kinds of options and solutions with no obligation.

Microsoft is a trademark of Microsoft Corporation, Bluetooth is a trademark of Bluetooth Sig, Inc., Android is a trademark of Google Inc.



Brady products are sold on the condition that the purchaser will test them in actual use and determine for himself/herself their suitability to his/her intended purpose. Brady warrants to the purchaser that Brady products are free from defects in material and workmanship but limits its obligation under this warranty to the replacement of the product which has been shown to Brady's satisfaction to have been defective at the time of its purchase.

The warranty does not extend to any persons who have acquired the product from the purchaser. It is in lieu of any other warranty, including every warranty of sale-ability, marketability or suitability for the intended purpose, and is also in lieu of any other obligation or liability on the part of Brady.

Under no circumstances will Brady be liable for losses, damage, costs or subsequent damage of whatever nature which may arise in connection with the use of, or inability to use, Brady's products.

# Laboratory Identification

## Labels, printers & software for the laboratory

### The Brady Advantage

When it comes to identification, safety and compliance, there's a clear advantage to working with Brady. We put our customers first in everything we do.

Our goal is to give you an unrivalled customer experience. We are relentlessly committed to performance and excellence - in our products, services and people.

Our products and solutions perform in ways that others simply can't match. Our people perform in ways that regularly exceed your expectations, and our focus and discipline work toward solid, long-term performance for our customers.

In short, Brady is the company you trust when performance matters most.

Learn more about the Brady Advantage at: [www.bradyeurope.com](http://www.bradyeurope.com)

### Table of Content

4 Simplify Your Laboratory Identification

#### Laboratory Identification Labels

- 6 Choose your Application
- 8 Thermal transfer print ribbons
- 12 Vial / Tube Labels
- 18 Vial Top Labels
- 21 Centrifuge / Microcentrifuge Labels
- 27 Cryo Tubes & Vials
- 30 Conical / Large Tube Labels
- 38 Slide Labels
- 40 B-498 Re-Identify Tissue Cassettes Labels
- 41 Straw and Rod Labels
- 42 Well Plate Labels
- 46 Bottles / Flasks & Dishes
- 50 Bottle Tamper Seal Labels
- 52 General Lab ID

#### Label Printers and Barcode Scanners

- 58 Choose Your Printer
- 60 M210-LAB Label Printer
- 61 M211 Label Printer
- 62 BMP51 Label Printer
- 63 M610 Label Printer
- 64 M611 Label Printer
- 65 M710 Label Printer
- 66 BBP12 Label Printer
- 67 BradyPrinter i3300 Industrial Label Printer
- 68 BradyPrinter i5100 Industrial Label Printer
- 69 BradyPrinter i5300 Industrial Label Printer
- 70 BradyPrinter i7100 Industrial label printer
- 72 BradyJet J2000 Colour Label Printer
- 73 BradyJet J4000 Colour Label Printer
- 74 Label Creation Software
- 75 Scanners for Laboratories

#### Miscellaneous Products

- 78 Hazardous Substance Identification
- 81 Sorbent Products
- 83 Pipemarkers
- 83 Safety Signs on Rolls



# Simplify Your Laboratory Identification

Brady's laboratory identification products are designed to serve the world's biotechnology, agricultural, environmental and forensic researchers. Whether you work in pathology, histology, chromatography or other areas of science, Brady labelling solutions can help you maintain Good Laboratory Practice.

## Brady Sample Identification solutions:

- match existing vial, slide, and well plate sizes
- remain legible throughout processing and storage
- endure freezer storage, liquid nitrogen, autoclave, hot water baths and solvents including Xylene, DMSO and Ethanol
- allow bar coding for extensive information storage on even the tiniest sample
- integrate seamlessly with your Laboratory Information Management System (LIMS)

## Hand-written versus printed labels

Did you ever have to postpone research because of unidentified samples, or because nobody was able to read anymore what was once written on the sample you need? Printed laboratory labels, engineered specifically to identify samples, help avoid sample loss and a lot of frustration.



### Hand-Written Information

- Is difficult to read
- Smears when handled
- Has limited communication potential
- Fades over time when stored
- Is erased by chemicals

### Brady Printed Laboratory Labels

- Are crisp, clear and readable
- Do not smear nor fade
- Can hold much information
- Have increased durability
- Resist chemicals

### Lab-durable labels

Brady's special self-laminating or wrap around label protects your label's legend from extreme temperature, chemicals and solvents.

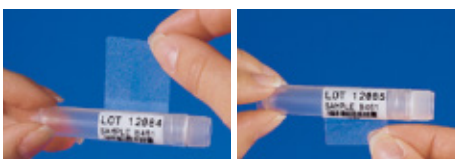

*For best adhesion, we recommend that you do not touch the adhesive side of the label when wrapping it around your vial or tube.*

- Printing is readable every time
- Clear portion wraps around and laminates the legend
- Provides window to view liquid level inside vial
- Low profile (extremely thin) label resists jamming in centrifuge or racks
- Labels withstand liquid nitrogen (-196°C), freezer (-80°C), autoclave (+121°C) and chemicals like Xylene

### On-site Label Creation

Brady printers enable professionals to print highly specialised identification labels on-site and on demand. Partnered with customisable software and a specific application system for laboratories, adaptable to specific processes or data file formats, Brady printers support considerable time savings and flexibility in sample identification.

Every Brady identification label can be printed on-site using a Brady mobile or benchtop printer. See page 58 for the full range of label printers.



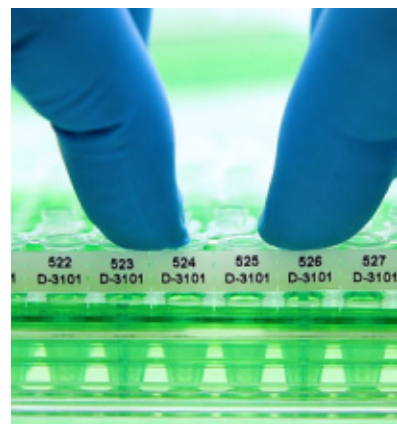
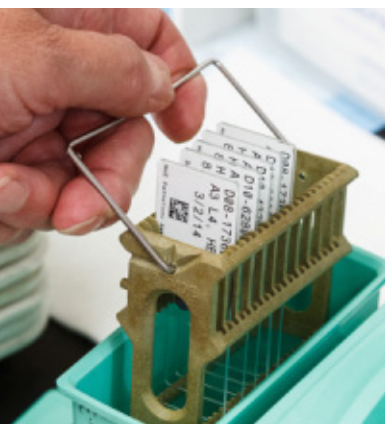

## Laboratory Identification Labels

Extensive material knowledge combined with chemical expertise enables Brady to develop durable labels that perform throughout sample storage and processing.

- 6 Choose your Application
- 8 Thermal transfer print ribbons
- 12 Vial / Tube Labels
- 18 Vial Top Labels
- 21 Centrifuge / Microcentrifuge Labels
- 27 Cryo Tubes & Vials
- 30 Conical / Large Tube Labels
- 38 Slide Labels
- 40 B-498 Re-Identify Tissue Cassettes Labels
- 41 Straw and Rod Labels
- 42 Well Plate Labels
- 46 Bottles / Flasks & Dishes
- 50 Bottle Tamper Seal Labels
- 52 General Lab ID

# Choose your Application



Vial/Tube



Conicals/bottles

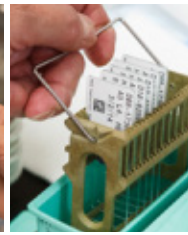

Slide



Tissue cassette

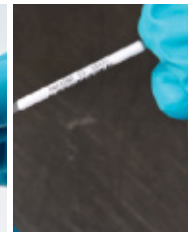

Straw



Well Plate



General Lab ID

| Material                       | Printer Ribbon Series         | Temp (°C)<br>(Tested for 30 days) |        | APPLICATION |                       |       |                 |       |            | ENVIRONMENT    |         |                 | Low-Profile (extremely thin) | Additional Features |                   |   |
|--------------------------------|-------------------------------|-----------------------------------|--------|-------------|-----------------------|-------|-----------------|-------|------------|----------------|---------|-----------------|------------------------------|---------------------|-------------------|---|
|                                |                               |                                   |        | Vial/Tube   | Conical / Large Tubes | Slide | Tissue Cassette | Straw | Well Plate | General Lab ID | Freezer | Liquid Nitrogen |                              |                     | Autoclave (121°C) | Hot Water Bath (100°C)  |
| <b>FreezerBondz™ Polyester</b> |                               |                                   |        |             |                       |       |                 |       |            |                |         |                 |                              |                     |                   |   |
| B-490                          | R4300                         | -196 °C                           | 130 °C | ✓           | ✓                     |       |                 |       |            | ✓              | ✓       | ✓               | ✓                            | ✓                   | ✓                 | Can be applied to frozen surfaces including glass and polypropylene stored in liquid nitrogen, except for Vial Tops. Material must slightly overlap itself.   |
| B-492                          | R6400                         | -196 °C                           | 110 °C | ✓           | ✓                     |       |                 |       |            | ✓              | ✓       | ✓               | ✓                            | ✓                   | ✓                 | Ultra thin; can label frosted/frozen (with overlap) or room temperature labels and lasts in liquid nitrogen and hot water baths   |
| <b>Nylon Cloth</b>             |                               |                                   |        |             |                       |       |                 |       |            |                |         |                 |                              |                     |                   |   |
| B-499                          | R4300, R6000HF, R6200B, R7950 | -196 °C                           | 90 °C  | ✓           | ✓                     |       |                 |       |            | ✓              | ✓       | ✓               | ✓                            | ✓                   |                   | Permanent adhesion; write-on capabilities. Temperature range increases to 121°C when used in autoclave process. Tested 3 cycles of 1 hour in 121°C at 15 psi for autoclave process. Available in white or yellow.         |
| <b>Paper</b>                   |                               |                                   |        |             |                       |       |                 |       |            |                |         |                 |                              |                     |                   |   |
| B-403                          | R4300                         | -70 °C                            | 100 °C |             |                       |       |                 |       |            |                |         |                 |                              |                     |                   | White dissolvable paper. Dissolves completely in water leaving no adhesive residue, ideal for temporary labelling applications  |
| B-424                          | R4300, R7950                  | -40 °C                            | 50 °C  |             |                       |       |                 |       |            | ✓              | ✓       |                 |                              |                     |                   | White paper material with matt finish and smooth top coat finish for thermal transfer printing. Good contrast and smear resistance for thermal barcode printing. Used for general purpose labeling applications           |
| <b>Polyester</b>               |                               |                                   |        |             |                       |       |                 |       |            |                |         |                 |                              |                     |                   |   |
| B-423                          | R4410, R6000HF                | -70 °C                            | 110 °C |             | ✓                     |       |                 |       |            | ✓              | ✓       | ✓               | ✓                            | ✓                   |                   | Widely used for component identification, barcoding, asset and inventory tracking.  |
| B-430                          | R6000HF                       | -70 °C                            | 100 °C |             | ✓                     |       |                 |       |            | ✓              | ✓       | ✓               | ✓                            | ✓                   |                   | Translucent, high performance polyester material with a glossy finish. Thermal transfer printable.  |
| B-432                          | R6000HF                       | -40 °C                            | 100 °C |             |                       |       |                 |       |            | ✓              | ✓       | ✓               | ✓                            |                     |                   | Translucent, high performance polyester material with a glossy finish. Thermal transfer printable. Very similar to B-430, but has a thicker layer of acrylic adhesive for better adherence to rough surface applications. |
| B-488                          | R4300, R7950                  | -40 °C                            | 145 °C |             | ✓                     | ✓     |                 |       |            | ✓              | ✓       | ✓               | ✓                            |                     |                   | White polyester thermal transfer printable material, similar to B-423, but with matt finish. Widely used for component identification, barcoding, asset and inventory tracking.   |
| B-533                          | R6000HF                       | -70 °C                            | 100 °C |             |                       |       |                 |       |            | ✓              | ✓       | ✓               | ✓                            |                     |                   | Removable, ideal for flat surfaces. Suitable to adhering to glass, but not polypropylene.   |
| B-8423                         | R6000HF                       | -70 °C                            | 110 °C |             | ✓                     |       |                 |       |            | ✓              | ✓       | ✓               | ✓                            |                     |                   | Permanent acrylic adhesive; semi-gloss finish; excellent for bar code labels.   |
| <b>Polypropylene</b>           |                               |                                   |        |             |                       |       |                 |       |            |                |         |                 |                              |                     |                   |   |
| B-425A                         | R6400                         | -70 °C                            | 80 °C  | ✓           | ✓                     |       |                 |       |            | ✓              | ✓       | ✓               |                              |                     |                   | White polypropylene material stock with matt finish for thermal transfer printing or write-on applications. Excellent solvent resistance and print performance; not recommended for long-term outdoor use.                |
| B-449                          | R7961                         | -70 °C                            | 90 °C  | ✓           | ✓                     |       |                 |       |            | ✓              | ✓       | ✓               | ✓                            |                     |                   | Ideal for temporary labelling applications. Removable from flat surfaces; write-on capabilities; Tested 3 cycles of 1 hour in 121°C at 15 psi for autoclave process.  |
| B-7425                         | R4300                         | -80 °C                            | 70 °C  | ✓           |                       | ✓     |                 |       |            | ✓              | ✓       | ✓               | ✓                            | ✓                   |                   | White Polypropylene material. Ideal for laboratory identification such as vials, centrifuge tubes and test tubes. For freezer or liquid nitrogen applications, B-7425 must be applied prior to being frozen.              |
| B-7600                         | R6000HF                       | -196 °C                           | 120 °C | ✓           | ✓                     |       |                 |       |            | ✓              | ✓       | ✓               | ✓                            |                     |                   | Clear polypropylene material with Permanent Acrylic Adhesive for Laboratory identification such as vials, centrifuge tubes and test tubes.  |

>>



Vial/Tube

Conicals/bottles

Slide

Tissue cassette

Straw

Well Plate

General Lab ID

| Material                         | Printer Ribbon Series | Temp (°C)<br>(Tested for 30 days) |        | APPLICATION |                       |       |                 |       |            | ENVIRONMENT    |         |                 |                   | Low-Profile (extremely thin) | Additional Features |  |
|----------------------------------|-----------------------|-----------------------------------|--------|-------------|-----------------------|-------|-----------------|-------|------------|----------------|---------|-----------------|-------------------|------------------------------|---------------------|--|
|                                  |                       |                                   |        | Vial/Tube   | Conical / Large Tubes | Slide | Tissue Cassette | Straw | Well Plate | General Lab ID | Freezer | Liquid Nitrogen | Autoclave (121°C) |                              |                     | Hot Water Bath (100°C)   |
| <b>Self-laminating Polyester</b> |                       |                                   |        |             |                       |       |                 |       |            |                |         |                 |                   |                              |                     |  |
| B-461                            | R4300, R7950          | -196 °C                           | 110 °C | ✓           | ✓                     |       |                 | ✓     |            |                |         | ✓               | ✓                 | ✓                            | ✓                   | Permanent adhesive; suitable for liquid nitrogen application if material is wrapped around itself, as in self-lamination; write-on capabilities. Temperature range increases to 121°C when used in autoclave process   |
| <b>Self-laminating Vinyl</b>     |                       |                                   |        |             |                       |       |                 |       |            |                |         |                 |                   |                              |                     |  |
| B-427                            | R4300                 | -40 °C                            | 60 °C  | ✓           | ✓                     |       |                 | ✓     |            |                |         | ✓               | ✓                 |                              |                     | Permanent acrylic adhesive; self-laminating; write-on capabilities; suitable for liquid nitrogen application and can be used to identify a frozen vial if label material is wrapped around itself, as in self-lamination. Temperature range goes to -196°C if material is wrapped around vial and overlaps itself.   |
| <b>StainerBondz™ Polyester</b>   |                       |                                   |        |             |                       |       |                 |       |            |                |         |                 |                   |                              |                     |  |
| B-481                            | R6400                 | -80 °C                            | 130 °C |             |                       | ✓     |                 |       |            |                |         | ✓               | ✓                 |                              | ✓                   | White polyester will remain resistant when exposed to xylene and other chemicals that are commonly used in the slide staining process  |
| <b>Tamper-resistant Vinyl</b>    |                       |                                   |        |             |                       |       |                 |       |            |                |         |                 |                   |                              |                     |  |
| B-351                            | R6200                 | -40 °C                            | 80 °C  |             |                       |       |                 |       |            | ✓              | ✓       | ✓               |                   |                              |                     | White vinyl material with matt finish. Tamper evident material fractures to show signs of product tampering and prevent one-piece removal.   |
| B-7351                           | R6200                 | -40 °C                            | 80 °C  |             |                       |       |                 |       |            | ✓              | ✓       | ✓               |                   |                              |                     | Fractures Easily, Prevents One-Piece Removal   |
| <b>Vinyl</b>                     |                       |                                   |        |             |                       |       |                 |       |            |                |         |                 |                   |                              |                     |  |
| B-439                            | R4410, R4900, R6010   | -70 °C                            | 40 °C  |             |                       |       |                 |       |            | ✓              | ✓       | ✓               |                   |                              |                     | Available in Blue, Green, Orange, Red, White and Yellow  |
| B-595                            | R4400, R6000HF, R6900 | -40 °C                            | 82 °C  |             |                       |       |                 |       |            | ✓              | ✓       | ✓               |                   |                              |                     | Durable, low-shrink vinyl with our most aggressive adhesive. Conforms to irregular, curved, rough and highly textured surfaces (painted cinder blocks, uneven wood, textured plastics, paper-jacketed pipes, powder-coated surfaces). Adheres to "difficult" low-surface energy items (PVC piping, blow-moulded equipment cases, ABS plastics, recycled plastics). Available in a wide range of colours. |
| <b>Vinyl Cloth</b>               |                       |                                   |        |             |                       |       |                 |       |            |                |         |                 |                   |                              |                     |  |
| B-498                            | R4300                 | -40 °C                            | 80 °C  | ✓           | ✓                     |       | ✓               | ✓     | ✓          |                |         |                 |                   |                              |                     | White vinyl cloth label material with glossy finish. The adhesive and cloth backing give excellent holding power, while being repositionable and removing cleanly.   |

## ▶ Part number explanation

Most Brady references for printable labels follow the same three-part format: The first code indicates the technology, the second part is a number indicating the label size (where applicable) and the third part indicates the Brady material (where applicable).

### M7-73-461

M710  
Technology

Label size  
code

Material  
(B-number)

# Thermal transfer print ribbons

## Thermal transfer print ribbons for M710, M610 and M611



| Ribbon Series     | Order Reference | Roll Width (mm) | Roll Length (m) | Formulation | Colour | Notes / Details  |
|-------------------|-----------------|-----------------|-----------------|-------------|--------|--|
| <b>M611, M610</b> |                 |                 |                 |             |        |  |
| R4300             | M61-R4310       | 50.00           | 22.86           | Wax/Resin   | Black  | M610 R4300 Series : chemical, environmental and smear resistant Black Ribbon   |
| R4400             | M61-R4410-WT    | 50.00           | 22.86           | Resin       | White  | M610 R4400 Series : high heat, scratch and solvent resistant White Ribbon  |
| R4400             | M61-R4410-RD    | 50.00           | 22.86           | Resin       | Red    | M610 R4400 Series : high heat, scratch and solvent resistant Red Ribbon  |
| R4400             | M61-R4410-BL    | 50.00           | 22.86           | Resin       | Blue   | M610 R4400 Series : high heat, scratch and solvent resistant Blue Ribbon   |
| R6000HF           | M61-R6010       | 50.00           | 22.86           | Resin       | Black  | M610 R6000 Series : high heat, scratch and solvent resistant Black Ribbon  |
| R6200             | M61-R6210       | 50.00           | 22.86           | Resin       | Black  | M610 R6200 Series : chemical, heat, scratch and smear resistant Black Ribbon   |
| R6400             | M61-R6410       | 50.00           | 22.86           | Resin       | Black  | M610 R6400 Series : abrasion and chemical resistant Black Ribbon   |
| <b>M710</b>       |                 |                 |                 |             |        |  |
| R6400             | M7-R6400        | 50.00           | 45.72           | Resin       | Black  | R6400 Series Resin Formulation offers superior chemical and abrasion resistance when printed on the appropriate label material from Brady®           |
| R4300             | M7-R4300        | 50.00           | 45.72           | Wax/Resin   | Black  | Recommended for printing on paper and films that have a matte or rough surface, such as B-427 Self-Laminating Vinyl and B-499 Nylon Cloth from Brady |
| R6000HF           | M7-R6000        | 50.00           | 45.72           | Resin       | Black  | R6000 series ribbons' resin formulation offers a high-performance images with excellent solvent and scratch resistance                               |
| R6200             | M7-R6200        | 50.00           | 45.72           | Resin       | Black  | R6200 Series Ribbons offer superior scratch, smear, heat and chemical resistance when printed on the appropriate label material from Brady®          |

## Thermal transfer print ribbons for BBP12



| Ribbon Series | Order Reference  | Roll Width (mm) | Roll Length (m) | Formulation | Colour | Notes / Details  |
|---------------|------------------|-----------------|-----------------|-------------|--------|--|
| R4900         | R4900-35X70/O    | 35.00           | 70.00           | Resin       | Black  | This ribbon has superb smear resistance at high temperatures and superior solvent resistance.  |
| R4900         | R4900-65X70/O    | 65.00           | 70.00           | Resin       | Black  | This ribbon has superb smear resistance at high temperatures and superior solvent resistance   |
| R4900         | R4900-85X70/O    | 85.00           | 70.00           | Resin       | Black  | This ribbon has superb smear resistance at high temperatures and superior solvent resistance   |
| R4900         | R4900-110X70/O   | 110.00          | 70.00           | Resin       | Black  | This ribbon has superb smear resistance at high temperatures and superior solvent resistance   |
| R6000HF       | R6000HF-65X70/O  | 65.00           | 70.00           | Resin       | Black  | High density halogen free ribbon, excellent solvent resistance, high heat resistance, and super scratch resistance.                        |
| R6000HF       | R6000HF-110X70/O | 110.00          | 70.00           | Resin       | Black  | High density halogen free ribbon, excellent solvent resistance, high heat resistance, and super scratch resistance.                        |
| R6200         | R6213            | 102.00          | 74.00           | Resin       | Black  | Designed for harsh environment labelling applications. Superior abrasion, chemical and heat resistance.                                    |
| R6400         | R6400-65X70/O    | 65.00           | 70.00           | Resin       | Black  | Ultra high chemical resistance at high temperatures. Superior solvent resistance.  |
| R6400         | R6400-110X70/O   | 110.00          | 70.00           | Resin       | Black  | Ultra high chemical resistance at high temperatures. Superior solvent resistance.  |
| R7950         | R7950-110X70/O   | 110.00          | 70.00           | Wax/Resin   | Black  | Strong environmental resistance against smearing and chemicals. Also, reliable, sharp-edge print quality to maximise bar code readability. |
| R7950         | R7950-35X70/O    | 35.00           | 70.00           | Wax/Resin   | Black  | Strong environmental resistance against smearing and chemicals. Also, reliable, sharp-edge print quality to maximise bar code readability. |
| R7950         | R7950-65X70/O    | 65.00           | 70.00           | Wax/Resin   | Black  | Strong environmental resistance against smearing and chemicals. Also, reliable, sharp-edge print quality to maximise bar code readability. |
| R7950         | R7950-85X70/O    | 85.00           | 70.00           | Wax/Resin   | Black  | Strong environmental resistance against smearing and chemicals. Also, reliable, sharp-edge print quality to maximise bar code readability. |
| R7961         | R7961-110X74/O   | 110.00          | 74.00           | Resin       | Black  | R7961 ribbon, when printed on the appropriate Brady label, gives excellent scratch and good chemical resistance.                           |



## Thermal transfer print ribbons for BradyPrinter i3300 and BradyPrinter i5300



| Ribbon Series | Order Reference | Roll Width (mm) | Roll Length (m) | Formulation | Colour | Notes / Details   |
|---------------|-----------------|-----------------|-----------------|-------------|--------|---|
| R4300         | B30-R4300       | 110.00          | 60.00           | Wax/Resin   | Black  | "Drop & Click" print ribbons for quick and easy supply changes. Ribbons are tough, smear-proof that produce long-lasting printed text. Print can withstand years in industrial areas and outdoor conditions.  |
| R4400         | B30-R4400-WT    | 110.00          | 60.00           | Resin       | White  | "Drop & Click" print ribbons for quick and easy supply changes. Ribbons are tough, smear-proof that produce long-lasting printed text. Print can withstand years in industrial areas and outdoor conditions.  |
| R6000HF       | B30-R6000HF     | 110.00          | 60.00           | Resin       | Black  | "Drop & Click" print ribbons for quick and easy supply changes. Ribbons are tough, smear-proof that produce long-lasting printed text. Print can withstand years in industrial areas and outdoor conditions.  |
| R6200         | B30-R6200       | 110.00          | 60.00           | Resin       | Black  | "Drop & Click" print ribbons for quick and easy supply changes. Ribbons are tough, smear-proof that produce long-lasting printed text. Print can withstand years in industrial areas and outdoor conditions.  |
| R6400         | B30-R6400       | 110.00          | 60.00           | Resin       | Black  | "Drop & Click" print ribbons for quick and easy supply changes. Ribbons are tough, smear-proof that produce long-lasting printed text. Print can withstand years in industrial areas and outdoor conditions.  |
| R10000        | B30-R10000      | 110.00          | 60.00           | Resin       | Black  | "Drop & Click" print ribbons for quick and easy supply changes. Ribbons are tough, smear-proof that produce long-lasting printed text. Print can withstand years in industrial areas and outdoor conditions.  |
| R10000        | B30-R10000-BL   | 110.00          | 60.00           | Resin       | Blue   | "Drop & Click" print ribbons for quick and easy supply changes. Ribbons are tough, smear-proof that produce long-lasting printed text. Print can withstand years in industrial areas and outdoor conditions.  |
| R10000        | B30-R10000-GN   | 110.00          | 60.00           | Resin       | Green  | "Drop & Click" print ribbons for quick and easy supply changes. Ribbons are tough, smear-proof that produce long-lasting printed text. Print can withstand years in industrial areas and outdoor conditions.  |
| R10000        | B30-R10000-OR   | 110.00          | 60.00           | Resin       | Orange | "Drop & Click" print ribbons for quick and easy supply changes. Ribbons are tough, smear-proof that produce long-lasting printed text. Print can withstand years in industrial areas and outdoor conditions.  |
| R10000        | B30-R10000-RD   | 110.00          | 60.00           | Resin       | Red    | "Drop & Click" print ribbons for quick and easy supply changes. Ribbons are tough, smear-proof that produce long-lasting printed text. Print can withstand years in industrial areas and outdoor conditions.  |
| R10000        | B30-R10000-WT   | 110.00          | 60.00           | Resin       | White  | "Drop & Click" print ribbons for quick and easy supply changes. Ribbons are tough, smear-proof that produce long-lasting printed text. Print can withstand years in industrial areas and outdoor conditions.  |
| R10000        | B30-R10000-YL   | 110.00          | 60.00           | Resin       | Yellow | "Drop & Click" print ribbons for quick and easy supply changes. Ribbons are tough, smear-proof that produce long-lasting printed text. Print can withstand years in industrial areas and outdoor conditions. B30-R10000-YL is designed for printing yellow on white; use B30-R10000-YL2 (sold separately) for printing yellow onto other colours                  |
| R10000        | B30-R10000-YL2  | 110.00          | 60.00           | Resin       | Yellow | "Drop & Click" print ribbons for quick and easy supply changes. Ribbons are tough, smear-proof and produce long-lasting printed text. Print can withstand years in industrial areas and outdoor conditions. B30-R10000-YL2 is specially designed to print yellow onto colours darker than white; B30-R10000-YL (sold separately) is designed for yellow on white. |

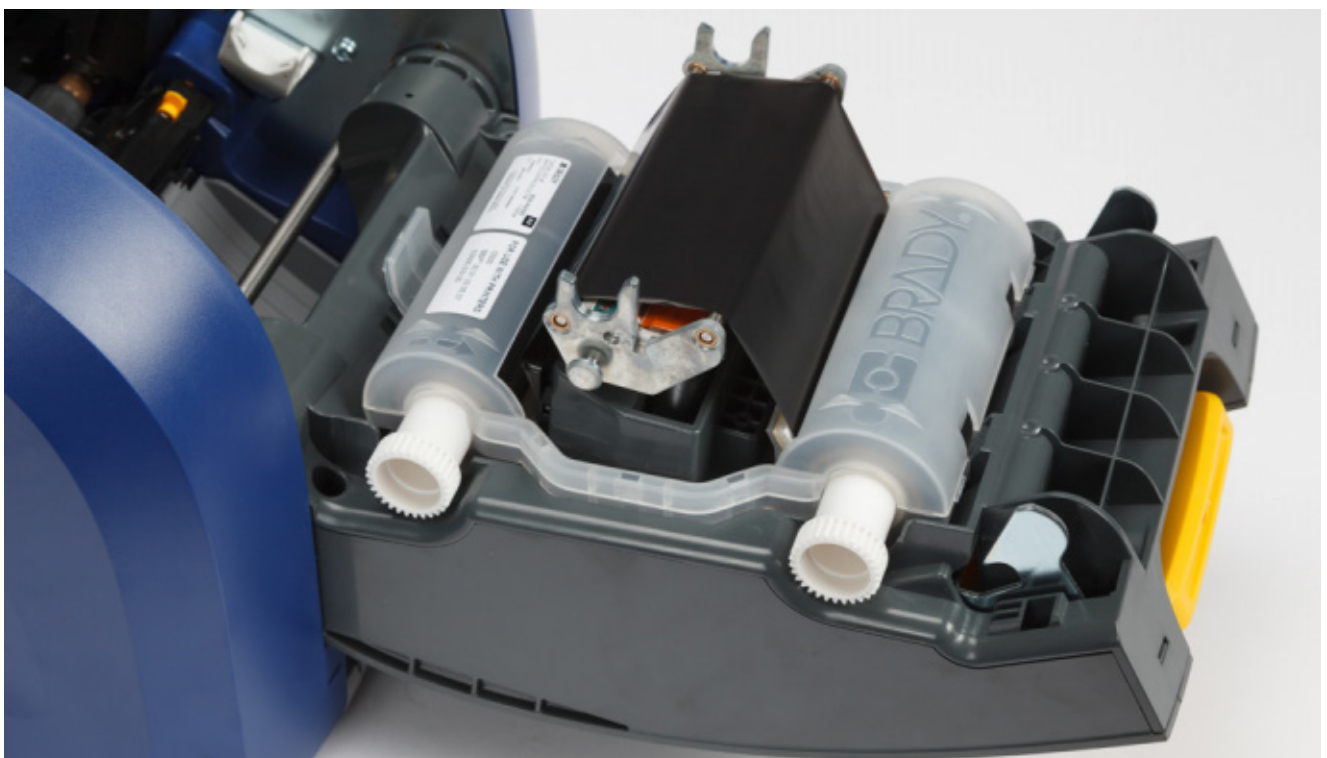

# Thermal transfer print ribbons

## Thermal transfer print ribbons for BradyPrinter i5100



| Ribbon Series | Order Reference | Roll Width (mm) | Roll Length (m) | Formulation | Colour | Notes / Details   |
|---------------|-----------------|-----------------|-----------------|-------------|--------|---|
| R4300         | IP-R4307        | 110.00          | 300.00          | Wax/Resin   | Black  | Strong environmental resistance against smearing and chemicals. Also, reliable, sharp-edge print quality to maximise bar code readability. Ribbons include spindle        |
| R4300         | IP-R4300        | 83.00           | 300.00          | Wax/Resin   | Black  | Strong environmental resistance against smearing and chemicals. Also, reliable, sharp-edge print quality to maximise bar code readability. Ribbons include spindle        |
| R4300         | IP-R4302        | 60.00           | 300.00          | Wax/Resin   | Black  | Strong environmental resistance against smearing and chemicals. Also, reliable, sharp-edge print quality to maximise bar code readability. Ribbons include spindle        |
| R4300         | IP-R4306        | 40.00           | 300.00          | Wax/Resin   | Black  | Strong environmental resistance against smearing and chemicals. Also, reliable, sharp-edge print quality to maximise bar code readability. Ribbons include spindle        |
| R4400         | IP-R4400-BL     | 60.00           | 300.00          | Resin       | Blue   | This ribbon is high density, excellent solvent resistance, high heat resistance, and super scratch resistance. Ribbons include spindle                                    |
| R4400         | IP-R4402-BL     | 83.00           | 300.00          | Resin       | Blue   | This ribbon is high density, excellent solvent resistance, high heat resistance, and super scratch resistance. Ribbons include spindle                                    |
| R4400         | IP-R4400-RD     | 60.00           | 300.00          | Resin       | Red    | This ribbon is high density, excellent solvent resistance, high heat resistance, and super scratch resistance. Ribbons include spindle                                    |
| R4400         | IP-R4402-GR     | 83.00           | 300.00          | Resin       | Green  | This ribbon is high density, excellent solvent resistance, high heat resistance, and super scratch resistance. Ribbons include spindle                                    |
| R4400         | IP-R4400-GR     | 60.00           | 300.00          | Resin       | Green  | This ribbon is high density, excellent solvent resistance, high heat resistance, and super scratch resistance. Ribbons include spindle                                    |
| R4400         | IP-R4402-RD     | 83.00           | 300.00          | Resin       | Red    | This ribbon is high density, excellent solvent resistance, high heat resistance, and super scratch resistance. Ribbons include spindle                                    |
| R4400         | IP-R4407-RD     | 110.00          | 300.00          | Resin       | Red    | This ribbon is high density, excellent solvent resistance, high heat resistance, and super scratch resistance. Ribbons include spindle                                    |
| R4400         | IP-R4407-BL     | 110.00          | 300.00          | Resin       | Blue   | This ribbon is high density, excellent solvent resistance, high heat resistance, and super scratch resistance. Ribbons include spindle                                    |
| R4900         | IP-R4900        | 83.00           | 300.00          | Resin       | Black  | This ribbon has superb smear resistance at high temperatures and superior solvent resistance. Ribbons include spindle   |
| R4900         | IP-R4902        | 60.00           | 300.00          | Resin       | Black  | This ribbon has superb smear resistance at high temperatures and superior solvent resistance. Ribbons include spindle   |
| R6000HF       | IP-R6007HF      | 110.00          | 300.00          | Resin       | Black  | The R-6000HF Series Thermal Transfer Ribbons are high density, halogen free ribbons with excellent solvent resistance, high heat resistance, and super scratch resistance |
| R6000HF       | IP-R6000HF      | 60.00           | 300.00          | Resin       | Black  | The R-6000HF Series Thermal Transfer Ribbons are high density, halogen free ribbons with excellent solvent resistance, high heat resistance, and super scratch resistance |
| R6000HF       | IP-R6002        | 83.00           | 300.00          | Resin       | Black  | The R-6000HF Series Thermal Transfer Ribbons are high density, halogen free ribbons with excellent solvent resistance, high heat resistance, and super scratch resistance |
| R6000HF       | IP-R6006HF      | 40.00           | 300.00          | Resin       | Black  | The R-6000HF Series Thermal Transfer Ribbons are high density, halogen free ribbons with excellent solvent resistance, high heat resistance, and super scratch resistance |
| R6200         | IP-R6206        | 40.00           | 300.00          | Resin       | Black  | Designed for harsh environment labelling applications. Superior abrasion, chemical and heat resistance. Ribbons include spindle   |
| R6200         | IP-R6200        | 60.00           | 300.00          | Resin       | Black  | Designed for harsh environment labelling applications. Superior abrasion, chemical and heat resistance. Ribbons include spindle   |
| R6200         | IP-R6202        | 83.00           | 300.00          | Resin       | Black  | Designed for harsh environment labelling applications. Superior abrasion, chemical and heat resistance. Ribbons include spindle   |
| R6200         | IP-R6207        | 110.00          | 300.00          | Resin       | Black  | Designed for harsh environment labelling applications. Superior abrasion, chemical and heat resistance. Ribbons include spindle   |
| R6400         | IP-R6402        | 83.00           | 300.00          | Resin       | Black  | Ultra high chemical resistance at high temperatures. Superior solvent resistance.   |
| R6400         | IP-R6407        | 110.00          | 300.00          | Resin       | Black  | Ultra high chemical resistance at high temperatures. Superior solvent resistance.   |
| R6400         | IP-R6406        | 40.00           | 300.00          | Resin       | Black  | Ultra high chemical resistance at high temperatures. Superior solvent resistance.   |
| R6400         | IP-R6400        | 60.00           | 300.00          | Resin       | Black  | Ultra high chemical resistance at high temperatures. Superior solvent resistance.   |

## Thermal transfer print ribbons for BradyPrinter i7100



| Ribbon Series | Order Reference  | Roll Width (mm) | Roll Length (m) | Formulation | Colour | Notes / Details  |
|---------------|------------------|-----------------|-----------------|-------------|--------|--|
| R4300         | R4307            | 110.00          | 300.00          | Wax/Resin   | Black  | Strong environmental resistance against smearing and chemicals. Also, reliable, sharp-edge print quality to maximise bar code readability. |
| R4300         | R4300            | 83.00           | 300.00          | Wax/Resin   | Black  | Strong environmental resistance against smearing and chemicals. Also, reliable, sharp-edge print quality to maximise bar code readability. |
| R4300         | R4302            | 60.00           | 300.00          | Wax/Resin   | Black  | Strong environmental resistance against smearing and chemicals. Also, reliable, sharp-edge print quality to maximise bar code readability. |
| R4300         | R4304            | 130.00          | 300.00          | Wax/Resin   | Black  | Strong environmental resistance against smearing and chemicals. Also, reliable, sharp-edge print quality to maximise bar code readability. |
| R4300         | R4306            | 40.00           | 300.00          | Wax/Resin   | Black  | Strong environmental resistance against smearing and chemicals. Also, reliable, sharp-edge print quality to maximise bar code readability. |
| R4300         | R4308            | 174.00          | 300.00          | Wax/Resin   | Black  | Strong environmental resistance against smearing and chemicals. Also, reliable, sharp-edge print quality to maximise bar code readability. |
| R4300         | R4311            | 25.40           | 300.00          | Wax/Resin   | Black  | Strong environmental resistance against smearing and chemicals. Also, reliable, sharp-edge print quality to maximise bar code readability. |
| R4400         | R4407-WT         | 110.00          | 300.00          | Resin       | White  | High density ribbon, excellent solvent resistance, high heat resistance, and super scratch resistance.                                     |
| R4400         | R4402-WT         | 83.00           | 300.00          | Resin       | White  | High density ribbon, excellent solvent resistance, high heat resistance, and super scratch resistance.                                     |
| R4400         | R4400-BL         | 60.00           | 300.00          | Resin       | Blue   | High density ribbon, excellent solvent resistance, high heat resistance, and super scratch resistance.                                     |
| R4400         | R4402-BL         | 83.00           | 300.00          | Resin       | Blue   | High density ribbon, excellent solvent resistance, high heat resistance, and super scratch resistance.                                     |
| R4400         | R4400-RD         | 60.00           | 300.00          | Resin       | Red    | High density ribbon, excellent solvent resistance, high heat resistance, and super scratch resistance.                                     |
| R4400         | R4402-GR         | 83.00           | 300.00          | Resin       | Green  | High density ribbon, excellent solvent resistance, high heat resistance, and super scratch resistance.                                     |
| R4400         | R4400-GR         | 60.00           | 300.00          | Resin       | Green  | High density ribbon, excellent solvent resistance, high heat resistance, and super scratch resistance.                                     |
| R4400         | R4402-RD         | 83.00           | 300.00          | Resin       | Red    | High density ribbon, excellent solvent resistance, high heat resistance, and super scratch resistance.                                     |
| R4400         | R4407-RD         | 110.00          | 300.00          | Resin       | Red    | High density ribbon, excellent solvent resistance, high heat resistance, and super scratch resistance.                                     |
| R4400         | R4407-BL         | 110.00          | 300.00          | Resin       | Blue   | High density ribbon, excellent solvent resistance, high heat resistance, and super scratch resistance.                                     |
| R4400         | R4400-WT         | 60.00           | 300.00          | Resin       | White  | High density ribbon, excellent solvent resistance, high heat resistance, and super scratch resistance.                                     |
| R4900         | R4907-110X300/O  | 110.00          | 300.00          | Resin       | Black  | This ribbon has superb smear resistance at high temperatures and superior solvent resistance   |
| R4900         | R4900            | 83.00           | 300.00          | Resin       | Black  | This ribbon has superb smear resistance at high temperatures and superior solvent resistance   |
| R4900         | R4902            | 60.00           | 300.00          | Resin       | Black  | This ribbon has superb smear resistance at high temperatures and superior solvent resistance   |
| R4900         | R4904            | 130.00          | 300.00          | Resin       | Black  | This ribbon has superb smear resistance at high temperatures and superior solvent resistance   |
| R6000HF       | R6000HF          | 40.00           | 300.00          | Resin       | Black  | High density halogen free ribbon, excellent solvent resistance, high heat resistance, and super scratch resistance.                        |
| R6000HF       | R6000HF          | 60.00           | 300.00          | Resin       | Black  | High density halogen free ribbon, excellent solvent resistance, high heat resistance, and super scratch resistance.                        |
| R6000HF       | R6002HF-83X300   | 83.00           | 300.00          | Resin       | Black  | High density halogen free ribbon, excellent solvent resistance, high heat resistance, and super scratch resistance.                        |
| R6000HF       | R6002HF          | 83.00           | 300.00          | Resin       | Black  | High density halogen free ribbon, excellent solvent resistance, high heat resistance, and super scratch resistance. (Plastic core)         |
| R6000HF       | R6007HF          | 110.00          | 300.00          | Resin       | Black  | High density halogen free ribbon, excellent solvent resistance, high heat resistance, and super scratch resistance.                        |
| R6000HF       | R6004HF          | 130.00          | 300.00          | Resin       | Black  | High density halogen free ribbon, excellent solvent resistance, high heat resistance, and super scratch resistance.                        |
| R6000HF       | R6000HF-30X300/O | 30.00           | 300.00          | Resin       | Black  | High density halogen free ribbon, excellent solvent resistance, high heat resistance, and super scratch resistance.                        |
| R6200         | R6206            | 40.00           | 300.00          | Resin       | Black  | Designed for harsh environment labelling applications. Superior abrasion, chemical and heat resistance.                                    |
| R6400         | R6407            | 110.00          | 300.00          | Resin       | Black  | Ultra high chemical resistance at high temperatures. Superior solvent resistance.  |
| R6400         | R6406            | 40.00           | 300.00          | Resin       | Black  | Ultra high chemical resistance at high temperatures. Superior solvent resistance.  |
| R6400         | R6400            | 60.00           | 300.00          | Resin       | Black  | Ultra high chemical resistance at high temperatures. Superior solvent resistance.  |
| R6400         | R6402            | 83.00           | 300.00          | Resin       | Black  | Ultra high chemical resistance at high temperatures. Superior solvent resistance.  |
| R7942         | R7942-90X300/O   | 90.00           | 300.00          | Wax         | Black  | General purpose, standard performance wax ribbon for paper and temporary labelling.  |
| R7950         | R7950-130X300/O  | 130.00          | 300.00          | Wax/Resin   | Black  | Strong environmental resistance against smearing and chemicals. Also, reliable, sharp-edge print quality to maximise bar code readability. |
| R7950         | R7950-114X300/I  | 114.00          | 300.00          | Wax/Resin   | Black  | Strong environmental resistance against smearing and chemicals. Also, reliable, sharp-edge print quality to maximise bar code readability. |
| R7950         | R7950-110X300/O  | 110.00          | 300.00          | Wax/Resin   | Black  | Strong environmental resistance against smearing and chemicals. Also, reliable, sharp-edge print quality to maximise bar code readability. |
| R7950         | R7950-90X300/O   | 90.00           | 300.00          | Wax/Resin   | Black  | Strong environmental resistance against smearing and chemicals. Also, reliable, sharp-edge print quality to maximise bar code readability. |
| R7950         | R7950-40X300/O   | 40.00           | 300.00          | Wax/Resin   | Black  | Strong environmental resistance against smearing and chemicals. Also, reliable, sharp-edge print quality to maximise bar code readability. |
| R7950         | R7950-60X300/O   | 60.00           | 300.00          | Wax/Resin   | Black  | Strong environmental resistance against smearing and chemicals. Also, reliable, sharp-edge print quality to maximise bar code readability. |
| R7950         | R7950-83X320/O   | 83.00           | 320.00          | Wax/Resin   | Black  | Strong environmental resistance against smearing and chemicals. Also, reliable, sharp-edge print quality to maximise bar code readability. |
| R7950         | R7950-170X300/O  | 170.00          | 300.00          | Wax/Resin   | Black  | Strong environmental resistance against smearing and chemicals. Also, reliable, sharp-edge print quality to maximise bar code readability. |
| R7950         | R7950-25X300/O   | 25.40           | 300.00          | Wax/Resin   | Black  | Strong environmental resistance against smearing and chemicals. Also, reliable, sharp-edge print quality to maximise bar code readability. |



## Vial / Tube Labels

Brady's vial and test tube labels are designed to withstand extreme laboratory solvents like Xylene, Ethanol, Alcohol and DMSO, ensuring that the specimen identification is always legible - and will not smear, fade or fall off.

- F** Freezer environment
- N** Liquid nitrogen environment
- A** Autoclave environment
- H** Hot water bath (100°C)
- S** Self-laminating label
- L** Low-profile (extremely thin) label
- R** Removable

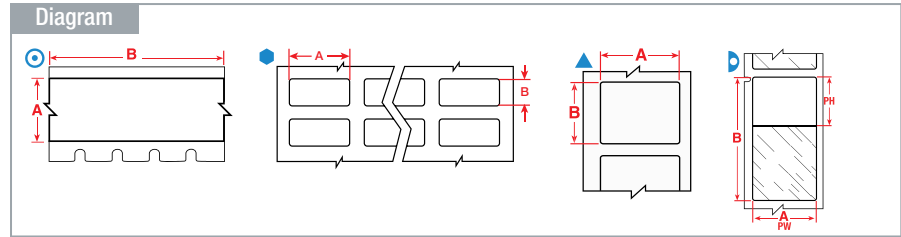

The background colours in the Order Reference column represent the material colour.

See page 58 for Brady's range of label printers.

Labels are shown per vial / tube size and in order of label width.

| Diagram             | Material | Special Properties | Label Width A (mm) | Label Height B (mm) | Label Length B (m) | Diameter C (mm) | Printable Area Width PW (mm) | Printable Area Height PH (mm) | Order Reference     | Printer Compatibility | Printer Ribbon Series | Labels per Roll | Labels per Row |
|---------------------|----------|--------------------|--------------------|---------------------|--------------------|-----------------|------------------------------|-------------------------------|---------------------|-----------------------|-----------------------|-----------------|----------------|
| <b>0.5 ml</b>       |          |                    |                    |                     |                    |                 |                              |                               |                     |                       |                       |                 |                |
| ⬢                   | B-499    | <b>F N A</b>       | 6.35               | 36.50               | -                  | -               | -                            | -                             | B33-90-499          | i3300, i5300          | B30 Monocolour Series | 2500            | 6              |
| ⊙                   | B-423    | <b>F A H</b>       | 6.35               | -                   | 6.40               | -               | -                            | -                             | M21-250-423         | M210-LAB, M211        | R6200                 | 1               | -              |
| ⬢                   | B-499    | <b>F N A</b>       | 19.05              | 6.35                | -                  | -               | -                            | -                             | B33-1-499           | i3300, i5300          | B30 Monocolour Series | 10000           | 4              |
| ▷                   | B-427    | <b>F N S</b>       | 25.40              | 63.50               | -                  | -               | 25.40                        | 19.05                         | M6-21-427           | M611, M610, M710      | R4300, R6200, R4400   | 100             | 1              |
| <b>0.5 - 0.7 ml</b> |          |                    |                    |                     |                    |                 |                              |                               |                     |                       |                       |                 |                |
| ▷                   | B-461    | <b>F N A H S L</b> | 9.53               | 45.72               | -                  | -               | 9.53                         | 19.05                         | M7-73-461           | M710                  | R6200                 | 250             | 1              |
| ▷                   | B-427    | <b>F N S</b>       | 12.70              | 19.05               | -                  | -               | 12.70                        | 9.53                          | M21-11-427          | M210-LAB, M211        | R4300, R4500          | 1               | 1              |
| ⬢                   | B-499    | <b>F N A</b>       | 12.70              | 19.05               | -                  | -               | -                            | -                             | B33-68-499          | i3300                 | B30 Monocolour Series | 1500            | 4              |
| ⬢                   | B-498    | <b>F R</b>         | 12.70              | 19.05               | -                  | -               | -                            | -                             | B33-68-498          | i3300                 | B30 Monocolour Series | 5000            | 4              |
| ⬢                   | B-490    | <b>F N H L</b>     | 12.70              | 19.05               | -                  | -               | -                            | -                             | B33-68-490          | i3300                 | B30 Monocolour Series | 2500            | 4              |
| ▲                   | B-498    | <b>F R</b>         | 12.70              | 19.05               | -                  | -               | -                            | -                             | BM-11-498           | M610, M611, M710      | R6200                 | 5000            | 1              |
| ▲                   | B-498    | <b>F R</b>         | 12.70              | 19.05               | -                  | -               | -                            | -                             | M7-11-498           | M710                  | R6200                 | 500             | 1              |
| ⬢                   | B-499    | <b>F N A</b>       | 12.70              | 19.05               | -                  | -               | -                            | -                             | THT-68-499-10       | BBP12, i7100, i5100   | R4900                 | 10000           | 4              |
| ⬢                   | B-498    | <b>F R</b>         | 12.70              | 19.05               | -                  | -               | -                            | -                             | THT-68-498-10       | BBP12, i7100, i5100   | R4300, R7950          | 10000           | 4              |
| ▲                   | B-499    | <b>F N A</b>       | 12.70              | 25.40               | -                  | -               | -                            | -                             | B33-620-499         | i3300                 | B30-R6000HF           | 1000            | 1              |
| ▲                   | B-499    | <b>F N A</b>       | 12.70              | 25.40               | -                  | -               | -                            | -                             | BPT-620-499         | BBP12                 | R7950                 | 1000            | 1              |
| ▷                   | B-427    | <b>F N S</b>       | 12.70              | 55.88               | -                  | -               | 12.70                        | 19.05                         | THT-127-427-3*      | BBP12, i7100, i5100   | R4300, R7950          | 3000            | 1              |
| ▲                   | B-499    | <b>F N A</b>       | 19.05              | 12.70               | -                  | -               | -                            | -                             | M21-11-499          | M210-LAB, M211        | R4300                 | 1               | 1              |
| ▲                   | B-423    | <b>F A H</b>       | 19.05              | 12.70               | -                  | -               | -                            | -                             | M21-7-423           | M210-LAB, M211        | R6000HF               | 1               | 1              |
| ⬢                   | B-499    | <b>F N A</b>       | 25.40              | 9.53                | -                  | -               | -                            | -                             | B33-152-499         | i3300                 | B30 Monocolour Series | 1500            | 2              |
| ▲                   | B-492    | <b>F N H L</b>     | 25.40              | 9.53                | -                  | -               | -                            | -                             | M7-16-492           | M710                  | R6400                 | 500             | 1              |
| ⬢                   | B-7600   | <b>F N H L</b>     | 25.40              | 9.53                | -                  | -               | -                            | -                             | THT-301-7600-3      | BBP12, i7100, i5100   | R6000HF               | 3000            | 2              |
| ⬢                   | B-7600   | <b>F N H L</b>     | 25.40              | 9.53                | -                  | -               | -                            | -                             | THT-301-7600-2.5SC  | BBP12                 | R6000HF               | 2500            | 2              |
| ⬢                   | B-499    | <b>F N A</b>       | 25.40              | 9.53                | -                  | -               | -                            | -                             | THT-152-499-3       | BBP12, i7100, i5100   | R4900                 | 3000            | 2              |
| ⬢                   | B-499    | <b>F N A</b>       | 25.40              | 9.53                | -                  | -               | -                            | -                             | THT-152-499-1.5-SC  | BBP12                 | R7950, R4300, R4900   | 1500            | 2              |
| ⬢                   | B-492    | <b>F N H L</b>     | 25.40              | 9.53                | -                  | -               | -                            | -                             | THT-152-492-3       | BBP12, i7100, i5100   | R6400                 | 3000            | 2              |
| ⬢                   | B-492    | <b>F N H L</b>     | 25.40              | 9.53                | -                  | -               | -                            | -                             | THT-152-492-2.5-SC  | BBP12                 | R6400                 | 2500            | 2              |
| ⬢                   | B-425A   | <b>F</b>           | 25.40              | 10.00               | -                  | -               | -                            | -                             | THT-30-425-10       | BBP12, i7100, i5100   | R6400                 | 10000           | 3              |
| ▷                   | B-461    | <b>F N A H S L</b> | 41.91              | 12.70               | -                  | -               | 19.05                        | 12.70                         | M6-202-461          | M610, M611            | R4300, R6200          | 500             | 1              |
| ▷                   | B-461    | <b>F N A H S L</b> | 45.72              | 15.24               | -                  | -               | 25.40                        | 15.24                         | M6-201-461          | M610, M611            | R4300, R6200          | 100             | 1              |
| ▷                   | B-461    | <b>F N A H S L</b> | 55.88              | 12.70               | -                  | -               | 19.05                        | 12.70                         | THT-127-461-3*      | BBP12, i7100, i5100   | R4300, R7950          | 3000            | 1              |
| ▷                   | B-461    | <b>F N A H S L</b> | 55.88              | 12.70               | -                  | -               | 19.05                        | 12.70                         | THT-127-461-1.5-SC* | BBP12                 | R7950                 | 1500            | 1              |
| ▷                   | B-461    | <b>F N A H S L</b> | 55.88              | 12.70               | -                  | -               | 55.88                        | 12.70                         | B33-127-461         | i3300                 | B30 Monocolour Series | 1500            | 3              |
| <b>0.5 - 2.0 ml</b> |          |                    |                    |                     |                    |                 |                              |                               |                     |                       |                       |                 |                |
| ▷                   | B-461    | <b>F N A H S L</b> | 63.50              | 38.10               | -                  | -               | 19.05                        | 38.10                         | M6-157-461          | M610, M611            | R4300                 | 100             | 1              |
| <b>0.5 - 8.0 ml</b> |          |                    |                    |                     |                    |                 |                              |                               |                     |                       |                       |                 |                |
| ▲                   | B-490    | <b>F N H L</b>     | 22.86              | 12.70               | -                  | -               | -                            | -                             | B33-125-490         | i3300                 | B30 Monocolour Series | 1650            | 1              |
| ▲                   | B-499    | <b>F N A</b>       | 25.40              | 12.70               | -                  | -               | -                            | -                             | M21-131-499         | M210-LAB, M211        | R4300                 | 1               | 1              |
| ▲                   | B-423    | <b>F A H</b>       | 25.40              | 12.70               | -                  | -               | -                            | -                             | M21-17-423          | M210-LAB, M211        | R6000HF               | 1               | 1              |

\*Label is rotated 90° on liner.

## Diagram

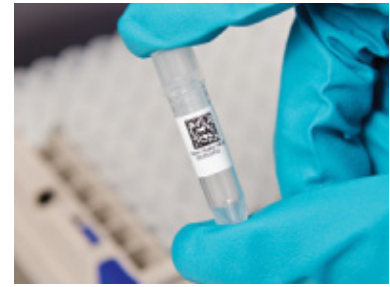
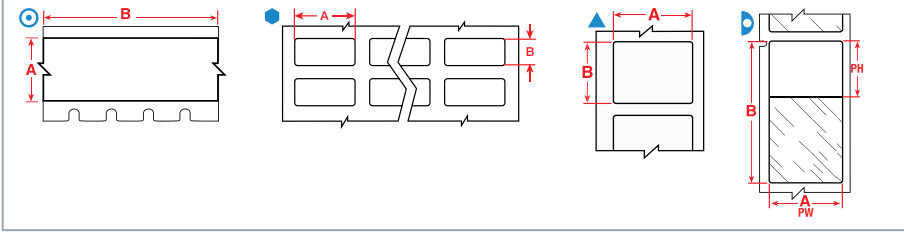

The background colours in the Order Reference column represent the material colour.

See page 58 for Brady's range of label printers.

Labels are shown per vial / tube size and in order of label width.

| Diagram             | Material | Special Properties          | Label Width A (mm) | Label Height B (mm) | Label Length B (m) | Diameter C (mm) | Printable Area Width PW (mm) | Printable Area Height PH (mm) | Order Reference    | Printer Compatibility | Printer Ribbon Series        | Labels per Roll | Labels per Row |
|---------------------|----------|-----------------------------|--------------------|---------------------|--------------------|-----------------|------------------------------|-------------------------------|--------------------|-----------------------|------------------------------|-----------------|----------------|
| <b>0.6 ml</b>       |          |                             |                    |                     |                    |                 |                              |                               |                    |                       |                              |                 |                |
| ⊙                   | B-499    | <b>FNA</b>                  | 9.53               | —                   | 4.88               | —               | —                            | —                             | M21-375-499        | M210-LAB, M211        | R4300                        | 1               | —              |
| ⊙                   | B-499    | <b>FNA</b>                  | 9.53               | —                   | 4.88               | —               | —                            | —                             | MC-375-499         | BMP41, BMP51          | R4300                        | 1               | —              |
| ⊙                   | B-7425   | <b>FNAHS</b>                | 9.53               | —                   | 6.40               | —               | —                            | —                             | M21-375-7425       | M210-LAB, M211        | R4300                        | 1               | —              |
| ⊙                   | B-461    | <b>FNAHSLS</b>              | 9.53               | —                   | 6.40               | —               | —                            | —                             | M21-375-461-AW**   | M210-LAB, M211        | R4300                        | 1               | —              |
| ▲                   | B-499    | <b>FNA</b>                  | 22.86              | 12.70               | —                  | —               | —                            | —                             | B33-125-499        | i3300                 | B30 Monocolour Series        | 1500            | 1              |
| ▲                   | B-499    | <b>FNA</b>                  | 22.86              | 12.70               | —                  | —               | —                            | —                             | M7-84-499          | M710                  | R4300, R4500, R6000HF, R6200 | 500             | 1              |
| ▲                   | B-499    | <b>FNA</b>                  | 22.86              | 12.70               | —                  | —               | —                            | —                             | THT-125-499-3      | BBP12, i7100, i5100   | R4900                        | 3000            | 1              |
| ▲                   | B-499    | <b>FNA</b>                  | 22.86              | 12.70               | —                  | —               | —                            | —                             | THT-125-499-1.5-SC | BBP12                 | R7950, R4300, R4900          | 1500            | 1              |
| <b>1.0 ml</b>       |          |                             |                    |                     |                    |                 |                              |                               |                    |                       |                              |                 |                |
| ▲                   | B-7425J  | <b>FNAHS</b>                | 33.02              | 15.24               | —                  | —               | —                            | —                             | J20-256-7425J      | J2000                 |                              | 1500            | 1              |
| <b>1.0 - 2.0 ml</b> |          |                             |                    |                     |                    |                 |                              |                               |                    |                       |                              |                 |                |
| ▷                   | B-461    | <b>FNAHSLS</b>              | 15.00              | 40.00               | —                  | —               | 15.00                        | 29.97                         | BPTLAB-21-461-2.5  | BBP12                 | R7950                        | 2500            | 1              |
| ▷                   | B-461    | <b>FNAHSLS</b>              | 15.24              | 38.10               | —                  | —               | 15.24                        | 33.00                         | M7-100-461         | M710                  | R6200                        | 500             | 1              |
| ▷                   | B-461    | <b>FNAHSLS</b>              | 15.24              | 38.10               | —                  | —               | 15.24                        | 33.02                         | B33-628-461        | i3300                 | B30-R4300                    | 2500            | 2              |
| ▷                   | B-461    | <b>FNAHSLS</b>              | 15.24              | 38.10               | —                  | —               | 15.24                        | 33.02                         | BPT-628-461        | BBP12                 | R7950                        | 2500            | 2              |
| ▷                   | B-461    | <b>FNAHSLS</b>              | 15.24              | 66.68               | —                  | —               | 15.24                        | 25.40                         | B33-612-461        | i3300                 | B30-R4300                    | 1500            | 3              |
| ▷                   | B-461    | <b>FNAHSLS</b>              | 15.24              | 66.68               | —                  | —               | 15.24                        | 25.40                         | BPT-612-461        | BBP12                 | R7950                        | 1500            | 3              |
| ▲                   | B-7425J  | <b>FNAHS</b>                | 20.96              | 6.35                | —                  | —               | —                            | —                             | J20-257-7425J      | J2000                 |                              | 1500            | 1              |
| ▷                   | B-461    | <b>FNAHSLS</b>              | 25.40              | 44.45               | —                  | —               | 25.40                        | 25.40                         | M7-106-461         | M710                  | R6200                        | 250             | 1              |
| ▷                   | B-461    | <b>FNAHSLS</b>              | 44.45              | 25.40               | —                  | —               | 25.40                        | 25.40                         | B33-183-461        | i3300                 | B30 Monocolour Series        | 2000            | 1              |
| <b>1.0 - 8.0 ml</b> |          |                             |                    |                     |                    |                 |                              |                               |                    |                       |                              |                 |                |
| ▷                   | B-461    | <b>FNAHSLS</b>              | 15.24              | 41.28               | —                  | —               | 15.24                        | 25.40                         | M7-76-461          | M710                  | R6200                        | 500             | 1              |
| ▷                   | B-461    | <b>FNAHSLS</b>              | 15.24              | 66.68               | —                  | —               | 15.24                        | 25.40                         | M7-86-461          | M710                  | R6200                        | 100             | 1              |
| ⊙                   | B-499    | <b>FNA</b>                  | 19.05              | 23.80               | —                  | —               | —                            | —                             | B33-91-499         | i3300, i5300          | B30 Monocolour Series        | 2500            | 4              |
| ⊙                   | B-498    | <b>F</b> <b>R</b>           | 19.05              | 23.80               | —                  | —               | —                            | —                             | THT-91-498-5       | BBP12, i7100, i5100   | R4300, R7950                 | 5000            | 4              |
| ▲                   | B-498    | <b>F</b> <b>R</b>           | 19.05              | 25.40               | —                  | —               | —                            | —                             | BM-18-498          | M610, M611, M710      | R6200                        | 2500            | 1              |
| ▲                   | B-499    | <b>FNA</b>                  | 19.05              | 25.40               | —                  | —               | —                            | —                             | M7-18-499          | M710                  | R4300                        | 250             | 1              |
| ▲                   | B-498    | <b>F</b> <b>R</b>           | 19.05              | 25.40               | —                  | —               | —                            | —                             | M7-18-498          | M710                  | R6200                        | 250             | 1              |
| ▲                   | B-499    | <b>FNA</b>                  | 22.86              | 12.70               | —                  | —               | —                            | —                             | M6-84-499          | M610, M611            | R4300, R6000HF, R6200        | 500             | 1              |
| ⊙                   | B-7425J  | <b>FNAHS</b>                | 25.40              | 9.53                | —                  | —               | —                            | —                             | J20-152-7425J      | J2000                 |                              | 2000            | 2              |
| ▷                   | B-427    | <b>FN</b> <b>S</b>          | 25.40              | 19.05               | —                  | —               | 25.40                        | 9.53                          | M21-18-427         | M210-LAB, M211        | R4300, R4500                 | 1               | 1              |
| ⊙                   | B-498    | <b>F</b> <b>R</b>           | 25.40              | 19.05               | —                  | —               | —                            | —                             | B33-88-498         | i3300                 | B30 Monocolour Series        | 2500            | 2              |
| ▲                   | B-498    | <b>F</b> <b>R</b>           | 25.40              | 19.05               | —                  | —               | —                            | —                             | M-48-498           | BMP41, BMP51          | R6200                        | 180             | —              |
| ▲                   | B-499    | <b>FNA</b>                  | 25.40              | 19.05               | —                  | —               | —                            | —                             | M21-18-499         | M210-LAB, M211        | R4300                        | 1               | 1              |
| ▲                   | B-423    | <b>F</b> <b>A</b> <b>H</b>  | 25.40              | 19.05               | —                  | —               | —                            | —                             | M21-18-423         | M210-LAB, M211        | R6000HF                      | 1               | 1              |
| ⊙                   | B-492    | <b>FN</b> <b>H</b> <b>L</b> | 25.40              | 19.05               | —                  | —               | —                            | —                             | THT-88-492-5       | BBP12, i7100, i5100   | R6400                        | 5000            | 2              |
| ▲                   | B-492    | <b>FN</b> <b>H</b> <b>L</b> | 25.40              | 19.05               | —                  | —               | —                            | —                             | THT-88-492-2.5-SC  | BBP12                 | R6400                        | 2500            | 2              |
| ▷                   | B-427    | <b>FN</b> <b>S</b>          | 25.40              | 66.68               | —                  | —               | 25.40                        | 25.40                         | B33-131-427        | i3300                 | B30 Monocolour Series        | 1500            | 1              |
| ▷                   | B-427    | <b>FN</b> <b>S</b>          | 25.40              | 66.68               | —                  | —               | 25.40                        | 25.40                         | M6-75-427          | M610, M611            | R4300                        | 100             | 1              |
| ▷                   | B-461    | <b>FNAHSLS</b>              | 25.40              | 66.68               | —                  | —               | 25.40                        | 25.40                         | M7-115-461         | M710                  | R6200                        | 100             | 1              |
| ▷                   | B-427    | <b>FN</b> <b>S</b>          | 25.40              | 66.68               | —                  | —               | 25.40                        | 25.40                         | THT-131-427-3*     | BBP12, i7100, i5100   | R4300, R7950                 | 3000            | 1              |
| ▷                   | B-461    | <b>FNAHSLS</b>              | 28.58              | 9.53                | —                  | —               | 19.05                        | 9.53                          | M6-123-461         | M610, M611            | R4300, R6200                 | 500             | 1              |
| ▷                   | B-461    | <b>FNAHSLS</b>              | 28.58              | 12.70               | —                  | —               | 19.05                        | 12.70                         | M6-122-461         | M610, M611            | R4300, R6200                 | 500             | 1              |
| ▲                   | B-7425J  | <b>FNAHS</b>                | 38.10              | 44.45               | —                  | —               | —                            | —                             | J20-258-7425J      | J2000                 |                              | 900             | 1              |
| ▲                   | B-494    | <b>FN</b> <b>H</b>          | 41.28              | 15.24               | —                  | —               | —                            | —                             | B33-302-494-BL     | i3300, i5300          | R6400                        | 1500            | 1              |

\*Label is rotated 90° on liner.

\*\*AW = All White / no transparent area.

>>>

# Vial / Tube Labels

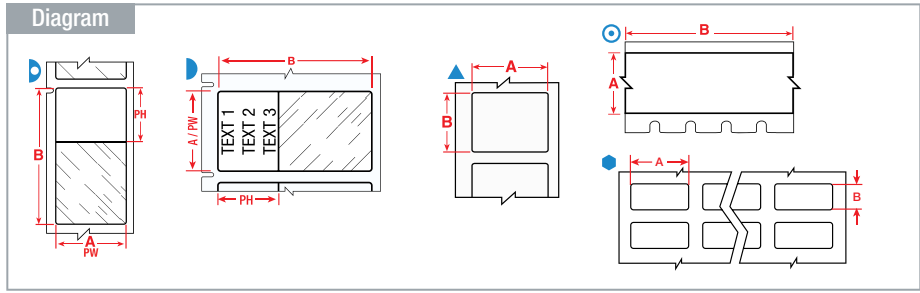

The background colours in the Order Reference column represent the material colour.

See page 58 for Brady's range of label printers.

Labels are shown per vial / tube size and in order of label width.

| Diagram             | Material | Special Properties | Label Width A (mm) | Label Height B (mm) | Label Length B (m) | Diameter C (mm) | Printable Area Width PW (mm) | Printable Area Height PH (mm) | Order Reference     | Printer Compatibility | Printer Ribbon Series | Labels per Roll | Labels per Row |
|---------------------|----------|--------------------|--------------------|---------------------|--------------------|-----------------|------------------------------|-------------------------------|---------------------|-----------------------|-----------------------|-----------------|----------------|
| <b>1.0 - 8.0 ml</b> |          |                    |                    |                     |                    |                 |                              |                               |                     |                       |                       |                 |                |
| ▲                   | B-494    | <b>F N H</b>       | 41.28              | 15.24               | -                  | -               | -                            | -                             | B33-302-494-GN      | i3300, i5300          | R6400                 | 1500            | 1              |
| ▲                   | B-494    | <b>F N H</b>       | 41.28              | 15.24               | -                  | -               | -                            | -                             | B33-302-494-OR      | i3300, i5300          | R6400                 | 1500            | 1              |
| ▲                   | B-494    | <b>F N H</b>       | 41.28              | 15.24               | -                  | -               | -                            | -                             | B33-302-494-PK      | i3300, i5300          | R6400                 | 1500            | 1              |
| ▲                   | B-494    | <b>F N H</b>       | 41.28              | 15.24               | -                  | -               | -                            | -                             | B33-302-494-RD      | i3300, i5300          | R6400                 | 1500            | 1              |
| ▲                   | B-494    | <b>F N H</b>       | 41.28              | 15.24               | -                  | -               | -                            | -                             | B33-302-494-YL      | i3300, i5300          | R6400                 | 1500            | 1              |
| ▲                   | B-492    | <b>F N H L</b>     | 41.28              | 15.24               | -                  | -               | -                            | -                             | B33-155-492         | i3300                 | B30 Monocolour Series | 1500            | 1              |
| ▲                   | B-490    | <b>F N H L</b>     | 41.28              | 15.24               | -                  | -               | -                            | -                             | B33-155-490         | i3300                 | B30 Monocolour Series | 1500            | 1              |
| ▲                   | B-490    | <b>F N H L</b>     | 41.28              | 15.24               | -                  | -               | -                            | -                             | M7-76-490           | M710                  | R4300                 | 500             | 1              |
| ▲                   | B-7600   | <b>F N H L</b>     | 41.28              | 15.24               | -                  | -               | -                            | -                             | THT-302-7600-3      | BBP12, i7100, i5100   | R6000HF               | 3000            | 1              |
| ▲                   | B-7600   | <b>F N H L</b>     | 41.28              | 15.24               | -                  | -               | -                            | -                             | THT-302-7600-1.5SC  | BBP12                 | R6000HF               | 1500            | 1              |
| ▲                   | B-492    | <b>F N H L</b>     | 41.28              | 15.24               | -                  | -               | -                            | -                             | THT-155-492-3       | BBP12, i7100, i5100   | R6400                 | 3000            | 1              |
| ▲                   | B-490    | <b>F N H L</b>     | 41.28              | 15.24               | -                  | -               | -                            | -                             | THT-155-490-3       | BBP12, i7100, i5100   | R4300, R7950          | 3000            | 1              |
| ▲                   | B-490    | <b>F N H L</b>     | 41.28              | 15.24               | -                  | -               | -                            | -                             | THT-155-490-1.5-SC  | BBP12                 | R7950                 | 1500            | 1              |
| ▷                   | B-461    | <b>F N A H S L</b> | 44.45              | 25.40               | -                  | -               | 25.40                        | 25.40                         | M6-203-461          | M610, M611            | R4300, R6200          | 100             | 1              |
| ▲                   | B-492    | <b>F N H L</b>     | 44.45              | 25.40               | -                  | -               | -                            | -                             | M-125-492           | BMP51                 | R6400                 | 180             | -              |
| ▲                   | B-492    | <b>F N H L</b>     | 48.26              | 25.40               | -                  | -               | -                            | -                             | B33-156-492         | i3300                 | B30 Monocolour Series | 1500            | 1              |
| ▲                   | B-490    | <b>F N H L</b>     | 48.26              | 25.40               | -                  | -               | -                            | -                             | B33-156-490         | i3300                 | B30 Monocolour Series | 1500            | 1              |
| ▲                   | B-490    | <b>F N H L</b>     | 48.26              | 25.40               | -                  | -               | -                            | -                             | M6-78-490           | M610, M611            | R4300                 | 250             | 1              |
| ▲                   | B-492    | <b>F N H L</b>     | 48.26              | 25.40               | -                  | -               | -                            | -                             | M7-78-492           | M710                  | R6400                 | 250             | 1              |
| ▲                   | B-7600   | <b>F N H L</b>     | 48.26              | 25.40               | -                  | -               | -                            | -                             | THT-303-7600-3      | BBP12, i7100, i5100   | R6000HF               | 3000            | 1              |
| ▲                   | B-7600   | <b>F N H L</b>     | 48.26              | 25.40               | -                  | -               | -                            | -                             | THT-303-7600-1.5SC  | BBP12                 | R6000HF               | 1500            | 1              |
| ▲                   | B-494    | <b>F N H</b>       | 48.26              | 25.40               | -                  | -               | -                            | -                             | THT-303-494-3-BL    | i5100, i7100          | R6400                 | 3000            | 1              |
| ▲                   | B-494    | <b>F N H</b>       | 48.26              | 25.40               | -                  | -               | -                            | -                             | THT-303-494-3-GN    | i5100, i7100          | R6400                 | 3000            | 1              |
| ▲                   | B-494    | <b>F N H</b>       | 48.26              | 25.40               | -                  | -               | -                            | -                             | THT-303-494-3-OR    | i5100, i7100          | R6400                 | 3000            | 1              |
| ▲                   | B-494    | <b>F N H</b>       | 48.26              | 25.40               | -                  | -               | -                            | -                             | THT-303-494-3-PK    | i5100, i7100          | R6400                 | 3000            | 1              |
| ▲                   | B-494    | <b>F N H</b>       | 48.26              | 25.40               | -                  | -               | -                            | -                             | THT-303-494-3-RD    | i5100, i7100          | R6400                 | 3000            | 1              |
| ▲                   | B-494    | <b>F N H</b>       | 48.26              | 25.40               | -                  | -               | -                            | -                             | THT-303-494-3-YL    | i5100, i7100          | R6400                 | 3000            | 1              |
| ▲                   | B-492    | <b>F N H L</b>     | 48.26              | 25.40               | -                  | -               | -                            | -                             | THT-156-492-3       | BBP12, i7100, i5100   | R6400                 | 3000            | 1              |
| ▲                   | B-492    | <b>F N H L</b>     | 48.26              | 25.40               | -                  | -               | -                            | -                             | THT-156-492-1.5-SC  | BBP12                 | R6400                 | 1500            | 1              |
| ▲                   | B-490    | <b>F N H L</b>     | 48.26              | 25.40               | -                  | -               | -                            | -                             | THT-156-490-3       | BBP12, i7100, i5100   | R4300, R7950          | 3000            | 1              |
| ▲                   | B-490    | <b>F N H L</b>     | 48.26              | 25.40               | -                  | -               | -                            | -                             | THT-156-490-1.5-SC  | BBP12                 | R7950                 | 1500            | 1              |
| ▷                   | B-461    | <b>F N A H S L</b> | 66.68              | 15.24               | -                  | -               | 25.40                        | 15.24                         | B33-153-461         | i3300                 | B30 Monocolour Series | 1500            | 1              |
| ▷                   | B-461    | <b>F N A H S L</b> | 66.68              | 25.40               | -                  | -               | 25.40                        | 25.40                         | BM-75-461           | M610, M611, M710      | R6200                 | 1000            | 1              |
| ▷                   | B-461    | <b>F N A H S L</b> | 66.68              | 25.40               | -                  | -               | 25.40                        | 25.40                         | M6-75-461           | M610, M611            | R4300                 | 100             | 1              |
| ▷                   | B-461    | <b>F N A H S L</b> | 66.68              | 25.40               | -                  | -               | 25.40                        | 25.40                         | M6-75-461-YL        | M610, M611            | R4300                 | 100             | 1              |
| ▷                   | B-461    | <b>F N A H S L</b> | 66.68              | 25.40               | -                  | -               | 25.40                        | 25.40                         | THT-131-461-3*      | BBP12, i7100, i5100   | R4300, R7950          | 3000            | 1              |
| ▷                   | B-461    | <b>F N A H S L</b> | 66.68              | 25.40               | -                  | -               | 25.40                        | 25.40                         | THT-131-461-1.5-SC* | BBP12                 | R7950                 | 1500            | 1              |
| ⊙                   | B-498    | <b>F R</b>         | 76.20              | 19.05               | -                  | -               | -                            | -                             | THT-88-498-5        | BBP12, i7100, i5100   | R4300, R7950          | 5000            | 2              |
| <b>1.5 ml</b>       |          |                    |                    |                     |                    |                 |                              |                               |                     |                       |                       |                 |                |
| ⊙                   | B-499    | <b>F N A</b>       | 12.70              | -                   | 4.88               | -               | -                            | -                             | M21-500-499         | M210-LAB, M211        | R4300                 | 1               | -              |
| ⊙                   | B-499    | <b>F N A</b>       | 12.70              | -                   | 4.88               | -               | -                            | -                             | MC-500-499          | BMP41, BMP51          | R4300                 | 1               | -              |
| ⊙                   | B-7425   | <b>F N A H</b>     | 12.70              | -                   | 6.40               | -               | -                            | -                             | M21-500-7425        | M210-LAB, M211        | R4300                 | 1               | -              |
| ⊙                   | B-461    | <b>F N A H S L</b> | 12.70              | -                   | 6.40               | -               | -                            | -                             | M21-500-461-AW**    | M210-LAB, M211        | R4300                 | 1               | -              |
| ⊙                   | B-499    | <b>F N A</b>       | 12.70              | -                   | 9.14               | -               | -                            | -                             | M7C-500-499         | M710                  | R4300, R6000HF, R6200 | 1               | 1              |

\*Label is rotated 90° on liner.

\*\*AW = All White / no transparent area.

>>>

**F** Freezer environment **N** Liquid nitrogen environment **A** Autoclave environment **H** Hot water bath (100°C) **S** Self-laminating label **L** Low-profile (extremely thin) label **R** Removable

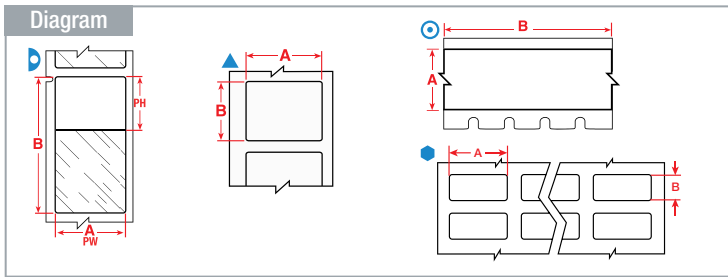

The background colours in the Order Reference column represent the material colour.

See page 58 for Brady's range of label printers.

Labels are shown per vial / tube size and in order of label width.

| Diagram             | Material | Special Properties | Label Width A (mm) | Label Height B (mm) | Label Length B (m) | Diameter C (mm) | Printable Area Width PW (mm) | Printable Area Height PH (mm) | Order Reference     | Printer Compatibility | Printer Ribbon Series | Labels per Roll | Labels per Row |
|---------------------|----------|--------------------|--------------------|---------------------|--------------------|-----------------|------------------------------|-------------------------------|---------------------|-----------------------|-----------------------|-----------------|----------------|
| <b>1.5 - 2.0 ml</b> |          |                    |                    |                     |                    |                 |                              |                               |                     |                       |                       |                 |                |
| ▲                   | B-492    | <b>F N H L</b>     | 12.70              | 41.91               | -                  | -               | -                            | -                             | M-124-492           | BMP51                 | R6400                 | 180             | -              |
| ▲                   | B-494    | <b>F N H</b>       | 25.40              | 12.70               | -                  | -               | -                            | -                             | B33-310-494-BL      | i3300, i5300          | R6400                 | 2500            | 1              |
| ▲                   | B-494    | <b>F N H</b>       | 25.40              | 12.70               | -                  | -               | -                            | -                             | B33-310-494-GN      | i3300, i5300          | R6400                 | 2500            | 1              |
| ▲                   | B-494    | <b>F N H</b>       | 25.40              | 12.70               | -                  | -               | -                            | -                             | B33-310-494-OR      | i3300, i5300          | R6400                 | 2500            | 1              |
| ▲                   | B-494    | <b>F N H</b>       | 25.40              | 12.70               | -                  | -               | -                            | -                             | B33-310-494-PK      | i3300, i5300          | R6400                 | 2500            | 1              |
| ▲                   | B-494    | <b>F N H</b>       | 25.40              | 12.70               | -                  | -               | -                            | -                             | B33-310-494-RD      | i3300, i5300          | R6400                 | 2500            | 1              |
| ▲                   | B-494    | <b>F N H</b>       | 25.40              | 12.70               | -                  | -               | -                            | -                             | B33-310-494-YL      | i3300, i5300          | R6400                 | 2500            | 1              |
| ▲                   | B-492    | <b>F N H L</b>     | 25.40              | 12.70               | -                  | -               | -                            | -                             | B33-59-492          | i3300                 | B30 Monocolour Series | 2500            | 1              |
| ▲                   | B-494    | <b>F N H</b>       | 25.40              | 12.70               | -                  | -               | -                            | -                             | BPT-310-494-2.5-BL  | BBP12                 | R6400                 | 2500            | 1              |
| ▲                   | B-494    | <b>F N H</b>       | 25.40              | 12.70               | -                  | -               | -                            | -                             | BPT-310-494-2.5-GN  | BBP12                 | R6400                 | 2500            | 1              |
| ▲                   | B-494    | <b>F N H</b>       | 25.40              | 12.70               | -                  | -               | -                            | -                             | BPT-310-494-2.5-OR  | BBP12                 | R6400                 | 2500            | 1              |
| ▲                   | B-494    | <b>F N H</b>       | 25.40              | 12.70               | -                  | -               | -                            | -                             | BPT-310-494-2.5-PK  | BBP12                 | R6400                 | 2500            | 1              |
| ▲                   | B-494    | <b>F N H</b>       | 25.40              | 12.70               | -                  | -               | -                            | -                             | BPT-310-494-2.5-RD  | BBP12                 | R6400                 | 2500            | 1              |
| ▲                   | B-494    | <b>F N H</b>       | 25.40              | 12.70               | -                  | -               | -                            | -                             | BPT-310-494-2.5-YL  | BBP12                 | R6400                 | 2500            | 1              |
| ▲                   | B-7600   | <b>F N H L</b>     | 25.40              | 12.70               | -                  | -               | -                            | -                             | THT-310-7600-10     | BBP12, i7100, i5100   | R6000HF               | 10000           | 1              |
| ▲                   | B-7600   | <b>F N H L</b>     | 25.40              | 12.70               | -                  | -               | -                            | -                             | THT-310-7600-2.5SC  | BBP12                 | R6000HF               | 2500            | 1              |
| ▲                   | B-494    | <b>F N H</b>       | 25.40              | 12.70               | -                  | -               | -                            | -                             | THT-310-494-10-BL   | i5100, i7100          | R6400                 | 10000           | 1              |
| ▲                   | B-494    | <b>F N H</b>       | 25.40              | 12.70               | -                  | -               | -                            | -                             | THT-310-494-10-GN   | i5100, i7100          | R6400                 | 10000           | 1              |
| ▲                   | B-494    | <b>F N H</b>       | 25.40              | 12.70               | -                  | -               | -                            | -                             | THT-310-494-10-OR   | i5100, i7100          | R6400                 | 10000           | 1              |
| ▲                   | B-494    | <b>F N H</b>       | 25.40              | 12.70               | -                  | -               | -                            | -                             | THT-310-494-10-PK   | i5100, i7100          | R6400                 | 10000           | 1              |
| ▲                   | B-494    | <b>F N H</b>       | 25.40              | 12.70               | -                  | -               | -                            | -                             | THT-310-494-10-RD   | i5100, i7100          | R6400                 | 10000           | 1              |
| ▲                   | B-494    | <b>F N H</b>       | 25.40              | 12.70               | -                  | -               | -                            | -                             | THT-310-494-10-YL   | i5100, i7100          | R6400                 | 10000           | 1              |
| ▲                   | B-492    | <b>F N H L</b>     | 25.40              | 12.70               | -                  | -               | -                            | -                             | THT-59-492-10       | BBP12, i7100, i5100   | R6400                 | 10000           | 1              |
| ▲                   | B-492    | <b>F N H L</b>     | 25.40              | 12.70               | -                  | -               | -                            | -                             | THT-59-492-2.5-SC   | BBP12                 | R6400                 | 2500            | 1              |
| ▷                   | B-461    | <b>F N A H S L</b> | 41.28              | 15.24               | -                  | -               | 15.24                        | 15.24                         | THT-133-461-1.5-SC* | BBP12                 | R7950                 | 1500            | 1              |
| ▷                   | B-461    | <b>F N A H S L</b> | 41.29              | 15.24               | -                  | -               | 25.40                        | 15.24                         | B33-133-461         | i3300                 | B30 Monocolour Series | 1500            | 3              |
| ▷                   | B-461    | <b>F N A H S L</b> | 41.29              | 15.24               | -                  | -               | 25.40                        | 15.24                         | THT-133-461-3*      | BBP12, i7100, i5100   | R4300, R7950          | 3000            | 1              |
| ▷                   | B-461    | <b>F N A H S L</b> | 66.68              | 15.24               | -                  | -               | 25.40                        | 15.24                         | THT-153-461-3*      | BBP12, i7100, i5100   | R4300, R7950          | 3000            | 1              |
| ▷                   | B-461    | <b>F N A H S L</b> | 66.68              | 15.24               | -                  | -               | 25.40                        | 15.24                         | THT-153-461-1.5-SC* | BBP12                 | R7950                 | 1500            | 1              |
| <b>1.5 - 8.0 ml</b> |          |                    |                    |                     |                    |                 |                              |                               |                     |                       |                       |                 |                |
| ◆                   | B-492    | <b>F N H L</b>     | 25.40              | 9.53                | -                  | -               | -                            | -                             | B33-152-492         | i3300                 | B30 Monocolour Series | 2500            | 2              |
| <b>2.0 - 4.0 ml</b> |          |                    |                    |                     |                    |                 |                              |                               |                     |                       |                       |                 |                |
| ▷                   | B-461    | <b>F N A H S L</b> | 15.24              | 48.26               | -                  | -               | 15.24                        | 39.88                         | B33-638-461         | i3300                 | B30-R4300             | 2000            | 1              |
| ▷                   | B-461    | <b>F N A H S L</b> | 15.24              | 48.26               | -                  | -               | 15.24                        | 39.88                         | BPT-638-461         | BBP12                 | R7950                 | 2000            | 1              |
| ▷                   | B-461    | <b>F N A H S L</b> | 15.24              | 48.26               | -                  | -               | 15.24                        | 40.00                         | M7-119-461          | M710                  | R6200                 | 500             | 1              |
| <b>2.0 - 8.0 ml</b> |          |                    |                    |                     |                    |                 |                              |                               |                     |                       |                       |                 |                |
| ▲                   | B-492    | <b>F N H L</b>     | 22.86              | 25.40               | -                  | -               | -                            | -                             | B33-180-492         | i3300                 | B30 Monocolour Series | 1500            | 1              |
| ▲                   | B-494    | <b>F N H</b>       | 25.40              | 12.70               | -                  | -               | 25.40                        | 9.53                          | M6-17-494-BL        | M611, M610            | R6400                 | 500             | 1              |
| ▲                   | B-494    | <b>F N H</b>       | 25.40              | 12.70               | -                  | -               | 25.40                        | 9.53                          | M6-17-494-GN        | M611, M610            | R6400                 | 500             | 1              |
| ▲                   | B-494    | <b>F N H</b>       | 25.40              | 12.70               | -                  | -               | 25.40                        | 9.53                          | M6-17-494-OR        | M611, M610            | R6400                 | 500             | 1              |
| ▲                   | B-494    | <b>F N H</b>       | 25.40              | 12.70               | -                  | -               | 25.40                        | 9.53                          | M6-17-494-PK        | M611, M610            | R6400                 | 500             | 1              |
| ▲                   | B-494    | <b>F N H</b>       | 25.40              | 12.70               | -                  | -               | 25.40                        | 9.53                          | M6-17-494-RD        | M611, M610            | R6400                 | 500             | 1              |
| ▲                   | B-494    | <b>F N H</b>       | 25.40              | 12.70               | -                  | -               | 25.40                        | 9.53                          | M6-17-494-YL        | M611, M610            | R6400                 | 500             | 1              |
| ▲                   | B-7425J  | <b>F N A H</b>     | 25.40              | 12.70               | -                  | -               | -                            | -                             | J20-59-7425J        | J2000                 |                       | 2000            | 1              |
| ◆                   | B-499    | <b>F N A</b>       | 25.40              | 19.05               | -                  | -               | -                            | -                             | B33-88-499          | i3300, i5300          | B30 Monocolour Series | 2500            | 2              |
| ◆                   | B-7425J  | <b>F N A H</b>     | 25.40              | 19.05               | -                  | -               | -                            | -                             | J20-88-7425J        | J2000                 |                       | 2000            | 2              |
| ▲                   | B-494    | <b>F N H</b>       | 25.40              | 25.40               | -                  | -               | 25.40                        | 22.23                         | M6-19-494-BL        | M611, M610            | R6400                 | 250             | 1              |
| ▲                   | B-494    | <b>F N H</b>       | 25.40              | 25.40               | -                  | -               | 25.40                        | 22.23                         | M6-19-494-GN        | M611, M610            | R6400                 | 250             | 1              |

\*Label is rotated 90° on liner.

>>

# Vial / Tube Labels

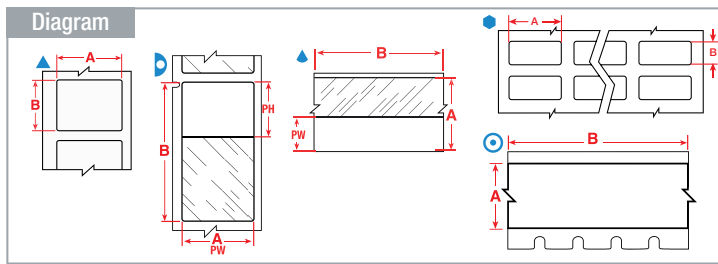

The background colours in the Order Reference column represent the material colour.

See page 58 for Brady's range of label printers.

Labels are shown per vial / tube size and in order of label width.

| Diagram               | Material | Special Properties | Label Width A (mm) | Label Height B (mm) | Label Length B (m) | Diameter C (mm) | Printable Area Width PW (mm) | Printable Area Height PH (mm) | Order Reference  | Printer Compatibility | Printer Ribbon Series | Labels per Roll | Labels per Row |
|-----------------------|----------|--------------------|--------------------|---------------------|--------------------|-----------------|------------------------------|-------------------------------|------------------|-----------------------|-----------------------|-----------------|----------------|
| <b>2.0 - 8.0 ml</b>   |          |                    |                    |                     |                    |                 |                              |                               |                  |                       |                       |                 |                |
| ▲                     | B-494    | <b>F N H</b>       | 25.40              | 25.40               | -                  | -               | 25.40                        | 22.23                         | M6-19-494-OR     | M611, M610            | R6400                 | 250             | 1              |
| ▲                     | B-494    | <b>F N H</b>       | 25.40              | 25.40               | -                  | -               | 25.40                        | 22.23                         | M6-19-494-PK     | M611, M610            | R6400                 | 250             | 1              |
| ▲                     | B-494    | <b>F N H</b>       | 25.40              | 25.40               | -                  | -               | 25.40                        | 22.23                         | M6-19-494-RD     | M611, M610            | R6400                 | 250             | 1              |
| ▲                     | B-494    | <b>F N H</b>       | 25.40              | 25.40               | -                  | -               | 25.40                        | 22.23                         | M6-19-494-YL     | M611, M610            | R6400                 | 250             | 1              |
| ▲                     | B-494    | <b>F N H</b>       | 25.40              | 25.40               | -                  | -               | 25.40                        | 22.23                         | THT-179-494-BL   | i7100, i5100, BBP12   | R6400                 | 3000            | 1              |
| ▲                     | B-494    | <b>F N H</b>       | 25.40              | 25.40               | -                  | -               | 25.40                        | 22.23                         | THT-179-494-GN   | i7100, i5100, BBP12   | R6400                 | 3000            | 1              |
| ▲                     | B-494    | <b>F N H</b>       | 25.40              | 25.40               | -                  | -               | 25.40                        | 22.23                         | THT-179-494-OR   | i7100, i5100, BBP12   | R6400                 | 3000            | 1              |
| ▲                     | B-494    | <b>F N H</b>       | 25.40              | 25.40               | -                  | -               | 25.40                        | 22.23                         | THT-179-494-PK   | i7100, i5100, BBP12   | R6400                 | 3000            | 1              |
| ▲                     | B-494    | <b>F N H</b>       | 25.40              | 25.40               | -                  | -               | 25.40                        | 22.23                         | THT-179-494-RD   | i7100, i5100, BBP12   | R6400                 | 3000            | 1              |
| ▲                     | B-494    | <b>F N H</b>       | 25.40              | 25.40               | -                  | -               | 25.40                        | 22.23                         | THT-179-494-YL   | i7100, i5100, BBP12   | R6400                 | 3000            | 1              |
| ▲                     | B-492    | <b>F N H L</b>     | 25.40              | 25.40               | -                  | -               | -                            | -                             | B33-179-492      | i3300                 | B30 Monocolour Series | 1900            | 1              |
| ▲                     | B-7425J  | <b>F N A H</b>     | 25.40              | 25.40               | -                  | -               | -                            | -                             | J20-179-7425J    | J2000                 |                       | 1500            | 1              |
| ◆                     | B-7425J  | <b>F N A H</b>     | 38.10              | 12.70               | -                  | -               | -                            | -                             | J20-37-7425J     | J2000                 |                       | 1500            | 2              |
| <b>2.0 - 50.0 ml</b>  |          |                    |                    |                     |                    |                 |                              |                               |                  |                       |                       |                 |                |
| ◆                     | B-427    | <b>F N S</b>       | 19.05              | -                   | 4.30               | -               | 9.53                         | -                             | M21-750-427      | M210-LAB, M211        | R4300                 | 1               | -              |
| ◎                     | B-499    | <b>F N A</b>       | 19.05              | -                   | 4.88               | -               | -                            | -                             | M21-750-499      | M210-LAB, M211        | R4300                 | 1               | -              |
| ◎                     | B-499    | <b>F N A</b>       | 19.05              | -                   | 4.88               | -               | -                            | -                             | MC-750-499       | BMP41, BMP51          | R4300                 | 1               | -              |
| ◎                     | B-7425   | <b>F N A H</b>     | 19.05              | -                   | 6.40               | -               | -                            | -                             | M21-750-7425     | M210-LAB, M211        | R4300                 | 1               | -              |
| ◎                     | B-461    | <b>F N A H S L</b> | 19.05              | -                   | 6.40               | -               | -                            | -                             | M21-750-461-AW** | M210-LAB, M211        | R4300                 | 1               | -              |
| ◆                     | B-427    | <b>F N S</b>       | 19.05              | -                   | 7.62               | -               | 9.53                         | -                             | MC-750-427       | BMP41, BMP51          | R4300                 | 1               | -              |
| ◎                     | B-499    | <b>F N A</b>       | 25.40              | -                   | 4.88               | -               | -                            | -                             | MC-1000-499      | BMP51                 | R4300                 | 1               | -              |
| ◎                     | B-499    | <b>F N A</b>       | 25.40              | -                   | 9.14               | -               | -                            | -                             | M7C-1000-499     | M710                  | R4300, R6000HF, R6200 | 1               | 1              |
| <b>4.0 - 8.0 ml</b>   |          |                    |                    |                     |                    |                 |                              |                               |                  |                       |                       |                 |                |
| ◆                     | B-499    | <b>F N A</b>       | 25.40              | 66.68               | -                  | -               | -                            | -                             | B33-625-499      | i3300                 | B30-R6000HF           | 1500            | 3              |
| ◆                     | B-499    | <b>F N A</b>       | 25.40              | 66.68               | -                  | -               | -                            | -                             | BPT-625-499      | BBP12                 | R7950                 | 1500            | 3              |
| <b>4.0 - 50.0 ml</b>  |          |                    |                    |                     |                    |                 |                              |                               |                  |                       |                       |                 |                |
| ▷                     | B-461    | <b>F N A H S L</b> | 34.93              | 45.72               | -                  | -               | 34.93                        | 39.88                         | B33-632-461      | i3300                 | B30-R4300             | 1500            | 1              |
| ▷                     | B-461    | <b>F N A H S L</b> | 34.93              | 45.72               | -                  | -               | 34.93                        | 39.88                         | BPT-632-461      | BBP12                 | R7950                 | 2000            | 1              |
| <b>5.0 - 50.0 ml</b>  |          |                    |                    |                     |                    |                 |                              |                               |                  |                       |                       |                 |                |
| ◎                     | B-499    | <b>F N A</b>       | 48.26              | -                   | 9.14               | -               | -                            | -                             | M71C-1900-499    | BMP71                 | M71-R4300             | 1               | 1              |
| <b>12.0 - 24.0 ml</b> |          |                    |                    |                     |                    |                 |                              |                               |                  |                       |                       |                 |                |
| ◆                     | B-499    | <b>F N A</b>       | 12.70              | 36.50               | -                  | -               | -                            | -                             | B33-87-499       | i3300, i5300          | B30 Monocolour Series | 2500            | 6              |
| ◆                     | B-498    | <b>F R</b>         | 12.70              | 36.50               | -                  | -               | -                            | -                             | B33-87-498       | i3300                 | B30 Monocolour Series | 2500            | 6              |
| ◆                     | B-498    | <b>F R</b>         | 12.70              | 36.50               | -                  | -               | -                            | -                             | THT-87-498-5     | BBP12, i7100, i5100   | R4300, R7950          | 5000            | 6              |
| ▲                     | B-498    | <b>F R</b>         | 12.70              | 38.10               | -                  | -               | -                            | -                             | BM-29-498        | M610, M611, M710      | R6200                 | 5000            | 1              |
| ▲                     | B-499    | <b>F N A</b>       | 50.80              | 19.05               | -                  | -               | -                            | -                             | M21-137-499      | M210-LAB, M211        | R4300                 | 1               | 1              |
| ▲                     | B-423    | <b>F A H</b>       | 50.80              | 19.05               | -                  | -               | -                            | -                             | M21-137-423      | M210-LAB, M211        | R6000HF               | 1               | 1              |
| ▷                     | B-461    | <b>F N A H S L</b> | 95.25              | 19.05               | -                  | -               | 25.40                        | 25.40                         | M6-79-461        | M610, M611            | R4300                 | 100             | 1              |
| <b>12.0 - 50.0 ml</b> |          |                    |                    |                     |                    |                 |                              |                               |                  |                       |                       |                 |                |
| ◆                     | B-499    | <b>F N A</b>       | 25.40              | 101.60              | -                  | -               | -                            | -                             | B33-326-499      | i3300, i5300          | B30 Monocolour Series | 450             | 2              |
| ◆                     | B-498    | <b>F R</b>         | 25.40              | 101.60              | -                  | -               | -                            | -                             | B33-326-498      | i3300, i5300          | B30 Monocolour Series | 450             | 2              |
| ▷                     | B-461    | <b>F N A H S L</b> | 133.35             | 25.40               | -                  | -               | 25.40                        | 25.40                         | B33-139-461      | i3300                 | B30 Monocolour Series | 650             | 2              |
| ▷                     | B-461    | <b>F N A H S L</b> | 133.35             | 25.40               | -                  | -               | 25.40                        | 25.40                         | THT-139-461-2    | BBP12, i7100, i5100   | R4300, R7950          | 2000            | 2              |
| <b>14.0 - 15.0 ml</b> |          |                    |                    |                     |                    |                 |                              |                               |                  |                       |                       |                 |                |
| ▲                     | B-7425J  | <b>F N A H</b>     | 38.10              | 19.05               | -                  | -               | -                            | -                             | J20-136-7425J    | J2000                 |                       | 1500            | 1              |
| ▲                     | B-499    | <b>F N A</b>       | 38.10              | 19.05               | -                  | -               | -                            | -                             | M21-136-499      | M210-LAB, M211        | R4300                 | 1               | 1              |
| ▲                     | B-423    | <b>F A H</b>       | 38.10              | 19.05               | -                  | -               | -                            | -                             | M21-30-423       | M210-LAB, M211        | R6000HF               | 1               | 1              |

\*\*AW = All White / no transparent area.



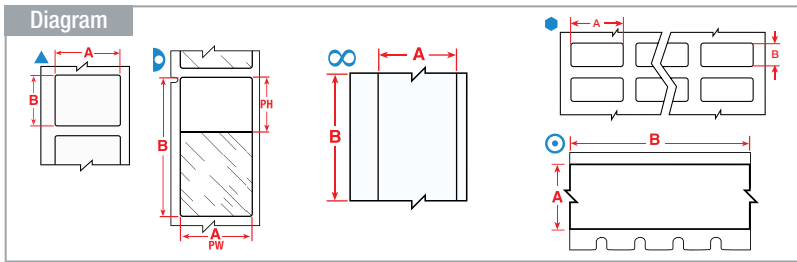

The background colours in the Order Reference column represent the material colour.

See page 58 for Brady's range of label printers.

Labels are shown per vial / tube size and in order of label width.

| Diagram               | Material | Special Properties | Label Width A (mm) | Label Height B (mm) | Label Length B (m) | Diameter C (mm) | Printable Area Width PW (mm) | Printable Area Height PH (mm) | Order Reference    | Printer Compatibility | Printer Ribbon Series               | Labels per Roll | Labels per Row |
|-----------------------|----------|--------------------|--------------------|---------------------|--------------------|-----------------|------------------------------|-------------------------------|--------------------|-----------------------|-------------------------------------|-----------------|----------------|
| <b>14.0 - 15.0 ml</b> |          |                    |                    |                     |                    |                 |                              |                               |                    |                       |                                     |                 |                |
| ▲                     | B-490    | <b>F N H L</b>     | 55.88              | 38.10               | -                  | -               | -                            | -                             | THT-157-490-3      | BBP12, i7100, i5100   | R4300, R7950                        | 3000            | 1              |
| ▲                     | B-490    | <b>F N H L</b>     | 55.88              | 38.10               | -                  | -               | -                            | -                             | THT-157-490-1.5-SC | BBP12                 | R7950                               | 1500            | 1              |
| <b>15.0 ml</b>        |          |                    |                    |                     |                    |                 |                              |                               |                    |                       |                                     |                 |                |
| ∞                     | B-7425J  | <b>F N A H</b>     | 28.58              | -                   | 30.48              | -               | -                            | -                             | J20C-1125-7425J    | J2000                 |                                     | 1               | 1              |
| ▲                     | B-7425J  | <b>F N A H</b>     | 38.10              | 25.40               | -                  | -               | -                            | -                             | J20-235-7425J      | J2000                 |                                     | 1250            | 1              |
| ▲                     | B-7425   | <b>F N A H</b>     | 38.10              | 25.40               | -                  | -               | -                            | -                             | M-31-7425          | BMP51                 | R4300                               | 250             | 1              |
| ∞                     | B-7425J  | <b>F N A H</b>     | 57.15              | -                   | 30.48              | -               | -                            | -                             | J20C-2250-7425J    | J2000                 |                                     | 1               | 1              |
| <b>15.0 - 50.0 ml</b> |          |                    |                    |                     |                    |                 |                              |                               |                    |                       |                                     |                 |                |
| ⬢                     | B-499    | <b>F N A</b>       | 12.70              | 25.40               | -                  | -               | -                            | -                             | B33-611-499        | i3300                 | B30-R6000HF                         | 3000            | 3              |
| ⬢                     | B-499    | <b>F N A</b>       | 12.70              | 25.40               | -                  | -               | -                            | -                             | BPT-611-499        | BBP12                 | R7950                               | 3000            | 3              |
| ⬢                     | B-498    | <b>F R</b>         | 12.70              | 25.40               | -                  | -               | -                            | -                             | BPT-611-498        | BBP12                 | R7950                               | 3000            | 3              |
| ▲                     | B-499    | <b>F N A</b>       | 25.40              | 12.45               | -                  | -               | -                            | -                             | B33-659-499        | i3300                 | B30-R6000HF                         | 1000            | 1              |
| ▲                     | B-499    | <b>F N A</b>       | 25.40              | 12.45               | -                  | -               | -                            | -                             | BPT-659-499        | BBP12                 | R7950                               | 1000            | 1              |
| ▲                     | B-498    | <b>F R</b>         | 25.40              | 12.45               | -                  | -               | -                            | -                             | BPT-659-498        | BBP12                 | R7950                               | 1000            | 1              |
| ⬢                     | B-499    | <b>F N A</b>       | 25.40              | 36.50               | -                  | -               | -                            | -                             | B33-621-499        | i3300                 | B30-R6000HF                         | 3000            | 3              |
| ⬢                     | B-499    | <b>F N A</b>       | 25.40              | 36.50               | -                  | -               | -                            | -                             | B33-89-499         | i3300, i5300          | B30 Monocolour Series               | 2300            | 3              |
| ⬢                     | B-498    | <b>F R</b>         | 25.40              | 36.50               | -                  | -               | -                            | -                             | B33-89-498         | i3300                 | B30 Monocolour Series               | 2300            | 3              |
| ⬢                     | B-499    | <b>F N A</b>       | 25.40              | 36.50               | -                  | -               | -                            | -                             | BPT-621-499        | BBP12                 | R7950                               | 3000            | 3              |
| ⬢                     | B-461    | <b>F N A H S L</b> | 66.68              | 25.40               | -                  | -               | 25.40                        | 25.40                         | B33-276-461        | i3300                 | B30 Monocolour Series               | 1500            | 2              |
| ⬢                     | B-461    | <b>F N A H S L</b> | 88.90              | 38.10               | -                  | -               | 88.90                        | 38.10                         | B33-134-461        | i3300                 | B30 Monocolour Series               | 1000            | 1              |
| ⬢                     | B-461    | <b>F N A H S L</b> | 88.90              | 38.10               | -                  | -               | 88.90                        | 38.10                         | THT-134-461-3*     | BBP12, i7100, i5100   | R4300, R7950                        | 3000            | 1              |
| <b>50.0 ml</b>        |          |                    |                    |                     |                    |                 |                              |                               |                    |                       |                                     |                 |                |
| ⊙                     | B-461    | <b>F N A H S L</b> | 9.53               | -                   | 15.24              | -               | -                            | -                             | M6C-375-461        | M610, M611            | R4300, R6200                        | 1               | 1              |
| ⊙                     | B-461    | <b>F N A H S L</b> | 12.70              | -                   | 15.24              | -               | -                            | -                             | M6C-500-461        | M610, M611            | R4300, R6200                        | 1               | 1              |
| ▲                     | B-499    | <b>F N A</b>       | 19.05              | 19.05               | -                  | -               | -                            | -                             | B33-254-499        | i3300, i5300          | B30 Monocolour Series               | 1000            | 1              |
| ▲                     | B-498    | <b>F R</b>         | 19.05              | 19.05               | -                  | -               | -                            | -                             | B33-254-498        | i3300, i5300          | B30 Monocolour Series               | 1000            | 1              |
| ▲                     | B-492    | <b>F N H L</b>     | 22.86              | 25.40               | -                  | -               | -                            | -                             | THT-180-492-3      | BBP12, i7100, i5100   | R6400                               | 3000            | 1              |
| ⬢                     | B-499    | <b>F N A</b>       | 25.40              | 12.70               | -                  | -               | -                            | -                             | B33-5-499          | i3300, i5300          | B30 Monocolour Series               | 5000            | 3              |
| ⬢                     | B-498    | <b>F R</b>         | 25.40              | 12.70               | -                  | -               | -                            | -                             | B33-5-498          | i3300                 | B30 Monocolour Series               | 5000            | 3              |
| ⬢                     | B-425A   | <b>F</b>           | 25.40              | 12.70               | -                  | -               | -                            | -                             | B33-5-425          | i3300                 | B30 Monocolour Series               | 5000            | 3              |
| ⬢                     | B-425A   | <b>F</b>           | 25.40              | 12.70               | -                  | -               | -                            | -                             | THT-5-425-10       | BBP12, i7100, i5100   | R6400                               | 10000           | 3              |
| ▲                     | B-7600   | <b>F N H L</b>     | 25.40              | 25.40               | -                  | -               | -                            | -                             | THT-305-7600-3     | BBP12, i7100, i5100   | R6000HF                             | 3000            | 1              |
| ▲                     | B-7600   | <b>F N H L</b>     | 25.40              | 25.40               | -                  | -               | -                            | -                             | THT-305-7600-2.5SC | BBP12                 | R6000HF                             | 2500            | 1              |
| ▲                     | B-492    | <b>F N H L</b>     | 25.40              | 25.40               | -                  | -               | -                            | -                             | THT-179-492-3      | BBP12, i7100, i5100   | R6400                               | 3000            | 1              |
| ▲                     | B-492    | <b>F N H L</b>     | 25.40              | 25.40               | -                  | -               | -                            | -                             | THT-179-492-2.5-SC | BBP12                 | R6400                               | 2500            | 1              |
| ⬢                     | B-499    | <b>F N A</b>       | 25.40              | 63.50               | -                  | -               | -                            | -                             | B33-325-499        | i3300, i5300          | B30 Monocolour Series               | 700             | 2              |
| ⬢                     | B-498    | <b>F R</b>         | 25.40              | 63.50               | -                  | -               | -                            | -                             | B33-325-498        | i3300, i5300          | B30 Monocolour Series               | 700             | 2              |
| ▲                     | B-499    | <b>F N A</b>       | 25.40              | 63.50               | -                  | -               | -                            | -                             | M7-21-499          | M710                  | R4300, R4500, R4900, R6000HF, R6200 | 100             | 1              |
| ⬢                     | B-499    | <b>F N A</b>       | 38.10              | 101.60              | -                  | -               | -                            | -                             | B33-327-499        | i3300, i5300          | B30 Monocolour Series               | 450             | 2              |
| ⬢                     | B-498    | <b>F R</b>         | 38.10              | 101.60              | -                  | -               | -                            | -                             | B33-327-498        | i3300, i5300          | B30 Monocolour Series               | 450             | 2              |
| ⬢                     | B-499    | <b>F N A</b>       | 38.10              | 152.40              | -                  | -               | -                            | -                             | B33-328-499        | i3300, i5300          | B30 Monocolour Series               | 300             | 2              |
| ⬢                     | B-498    | <b>F R</b>         | 38.10              | 152.40              | -                  | -               | -                            | -                             | B33-328-498        | i3300, i5300          | B30 Monocolour Series               | 300             | 2              |
| ▲                     | B-490    | <b>F N H L</b>     | 50.80              | 6.35                | -                  | -               | -                            | -                             | B33-151-490        | i3300                 | B30 Monocolour Series               | 2500            | 1              |
| ▲                     | B-7425J  | <b>F N A H</b>     | 50.80              | 6.35                | -                  | -               | -                            | -                             | J20-151-7425J      | J2000                 |                                     | 2000            | 1              |
| ▲                     | B-7425J  | <b>F N A H</b>     | 50.80              | 25.40               | -                  | -               | -                            | -                             | J20-137-7425J      | J2000                 |                                     | 1500            | 1              |
| ▲                     | B-7425J  | <b>F N A H</b>     | 76.20              | 25.40               | -                  | -               | -                            | -                             | J20-18-7425J       | J2000                 |                                     | 1000            | 1              |

\*Label is rotated 90° on liner.

**F** Freezer environment **N** Liquid nitrogen environment **A** Autoclave environment **H** Hot water bath (100°C) **S** Self-laminating label **L** Low-profile (extremely thin) label **R** Removable

# Vial Top Labels



## Vial Top Labels

Save time by using the Vial and Vial top combination labels - print your information in one go.

**SAMPLE #:** 4368  
**LOT:** A-1225, JJB

**SAMPLE #:** 4367  
**LOT:** A-1225, JJB

**SAMPLE #:** 4366  
**LOT:** A-1225, JJB

**F** Freezer environment  
**N** Liquid nitrogen environment  
**A** Autoclave environment  
**H** Hot water bath (100°C)  
**S** Self-laminating label  
**L** Low-profile (extremely thin) label  
**R** Removable

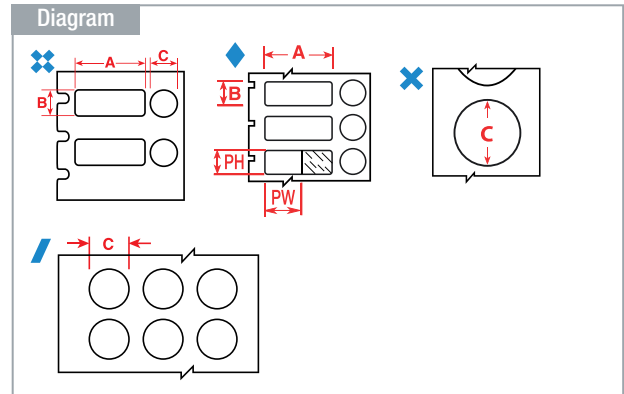

The background colours in the Order Reference column represent the material colour. See page 58 for Brady's range of label printers.

Labels are shown per vial / tube size and in order of label width.

| Diagram              | Material | Special Properties | Label Width A (mm) | Label Height B (mm) | Diameter C (mm) | Printable Area Width PW (mm) | Printable Area Height PH (mm) | Order Reference    | Printer Compatibility | Printer Ribbon Series | Labels per Roll | Labels per Row |
|----------------------|----------|--------------------|--------------------|---------------------|-----------------|------------------------------|-------------------------------|--------------------|-----------------------|-----------------------|-----------------|----------------|
| <b>0.5 - 0.7 ml</b>  |          |                    |                    |                     |                 |                              |                               |                    |                       |                       |                 |                |
| ◆                    | B-461    | <b>F A H S L</b>   | 25.40              | 9.53                | 9.53            | 25.40                        | 9.53                          | B33-606-461        | i3300                 | B30-R4300             | 1000            | 1              |
| ◆                    | B-461    | <b>F A H S L</b>   | 25.40              | 9.53                | 9.53            | 25.40                        | 9.53                          | BPT-606-461        | BBP12                 | R7950                 | 1000            | 1              |
| ⊠                    | B-499    | <b>F A</b>         | 25.40              | 9.53                | 9.53            | -                            | -                             | M7-98-499          | M710                  | R4300                 | 500             | 1              |
| <b>0.5 - 1.5 ml</b>  |          |                    |                    |                     |                 |                              |                               |                    |                       |                       |                 |                |
| ×                    | B-499    | <b>F A</b>         | -                  | -                   | 9.53            | -                            | -                             | M-82-499           | BMP41, BMP51          | R4300                 | 240             | -              |
| ×                    | B-499    | <b>F A</b>         | -                  | -                   | 9.53            | -                            | -                             | M-82-499-OR-BK     | BMP41, BMP51          | R4300                 | 240             | -              |
| ×                    | B-499    | <b>F A</b>         | -                  | -                   | 9.53            | -                            | -                             | M-82-499-RD-BK     | BMP41, BMP51          | R4300                 | 240             | -              |
| ×                    | B-499    | <b>F A</b>         | -                  | -                   | 9.53            | -                            | -                             | M-82-499-YL-BK     | BMP41, BMP51          | R4300                 | 240             | -              |
| ×                    | B-492    | <b>F H L</b>       | -                  | -                   | 9.53            | -                            | -                             | M-82-492           | BMP41, BMP51          | R6400                 | 240             | -              |
| <b>0.5 - 8.0 ml</b>  |          |                    |                    |                     |                 |                              |                               |                    |                       |                       |                 |                |
| ⊠                    | B-499    | <b>F A</b>         | 25.40              | 9.53                | 9.53            | -                            | -                             | THT-249-499-1.5-SC | BBP12                 | R7950, R4300, R4900   | 1500            | 1              |
| ⊠                    | B-492    | <b>F H L</b>       | 25.40              | 9.53                | 9.53            | -                            | -                             | THT-249-492-1.5-SC | BBP12                 | R6400                 | 1500            | 1              |
| ⊠                    | B-492    | <b>F H L</b>       | 25.40              | 12.70               | 9.53            | -                            | -                             | THT-250-492-1.5-SC | BBP12                 | R6400                 | 1500            | 1              |
| ⊠                    | B-492    | <b>F H L</b>       | 25.40              | 12.70               | 11.18           | -                            | -                             | THT-251-492-1.5-SC | BBP12                 | R6400                 | 1500            | 1              |
| <b>0.6 - 1.5 ml</b>  |          |                    |                    |                     |                 |                              |                               |                    |                       |                       |                 |                |
| ⊠                    | B-492    | <b>F H L</b>       | 25.40              | 9.53                | 9.53            | -                            | -                             | M6-98-492          | M610, M611            | R4300, R6400          | 500             | 1              |
| ⊠                    | B-492    | <b>F H L</b>       | 25.40              | 12.70               | 9.53            | -                            | -                             | M6-120-492         | M610, M611            | R4300, R6400          | 250             | 1              |
| /                    | B-499    | <b>F A</b>         | -                  | -                   | 9.53            | -                            | -                             | B33-143-499        | i3300                 | B30 Monocolour Series | 1500            | 4              |
| /                    | B-492    | <b>F H L</b>       | -                  | -                   | 9.53            | -                            | -                             | B33-143-492        | i3300                 | B30 Monocolour Series | 1500            | 4              |
| ×                    | B-499    | <b>F A</b>         | -                  | -                   | 9.53            | -                            | -                             | M7-82-499          | M710                  | R4300, R6000HF, R6200 | 500             | 1              |
| /                    | B-499    | <b>F A</b>         | -                  | -                   | 9.53            | -                            | -                             | THT-143-499-3      | BBP12, i7100, i5100   | R4900                 | 3000            | 4              |
| /                    | B-492    | <b>F H L</b>       | -                  | -                   | 9.53            | -                            | -                             | THT-143-492-3      | BBP12, i7100, i5100   | R6400                 | 3000            | 4              |
| /                    | B-492    | <b>F H L</b>       | -                  | -                   | 9.53            | -                            | -                             | THT-143-492-1.5-SC | BBP12                 | R6400                 | 1500            | 4              |
| <b>0.6 - 50.0 ml</b> |          |                    |                    |                     |                 |                              |                               |                    |                       |                       |                 |                |
| /                    | B-499    | <b>F A</b>         | -                  | -                   | 9.53            | -                            | -                             | B33-602-499        | i3300                 | B30-R6000HF           | 3000            | 3              |
| /                    | B-499    | <b>F A</b>         | -                  | -                   | 9.53            | -                            | -                             | B33-602-499YL      | i3300                 | B30-R6000HF           | 3000            | 3              |
| /                    | B-461    | <b>F A H L</b>     | -                  | -                   | 9.53            | -                            | -                             | B33-602-461AW**    | i3300                 | B30-R4300             | 3000            | 3              |
| /                    | B-499    | <b>F A</b>         | -                  | -                   | 9.53            | -                            | -                             | BPT-602-499        | BBP12                 | R7950                 | 3000            | 3              |
| /                    | B-499    | <b>F A</b>         | -                  | -                   | 9.53            | -                            | -                             | BPT-602-499YL      | BBP12                 | R7950                 | 3000            | 3              |
| ×                    | B-461    | <b>F A H L</b>     | -                  | -                   | 9.53            | -                            | -                             | BPT-602-461AW**    | BBP12                 | R7950                 | 3000            | 3              |
| /                    | B-499    | <b>F A</b>         | -                  | -                   | 12.70           | -                            | -                             | B33-603-499        | i3300                 | B30-R6000HF           | 3000            | 3              |
| /                    | B-499    | <b>F A</b>         | -                  | -                   | 12.70           | -                            | -                             | B33-603-499YL      | i3300                 | B30-R6000HF           | 3000            | 3              |
| /                    | B-499    | <b>F A</b>         | -                  | -                   | 12.70           | -                            | -                             | BPT-603-499        | BBP12                 | R7950                 | 3000            | 3              |
| /                    | B-499    | <b>F A</b>         | -                  | -                   | 12.70           | -                            | -                             | BPT-603-499YL      | BBP12                 | R7950                 | 3000            | 3              |
| /                    | B-461    | <b>F A H L</b>     | -                  | -                   | 15.24           | -                            | -                             | B33-604-461AW**    | i3300                 | B30-R4300             | 3000            | 3              |
| ×                    | B-461    | <b>F A H L</b>     | -                  | -                   | 15.24           | -                            | -                             | BPT-604-461AW**    | BBP12                 | R7950                 | 3000            | 3              |

\*\*AW = All White / no transparent area.



## Diagram

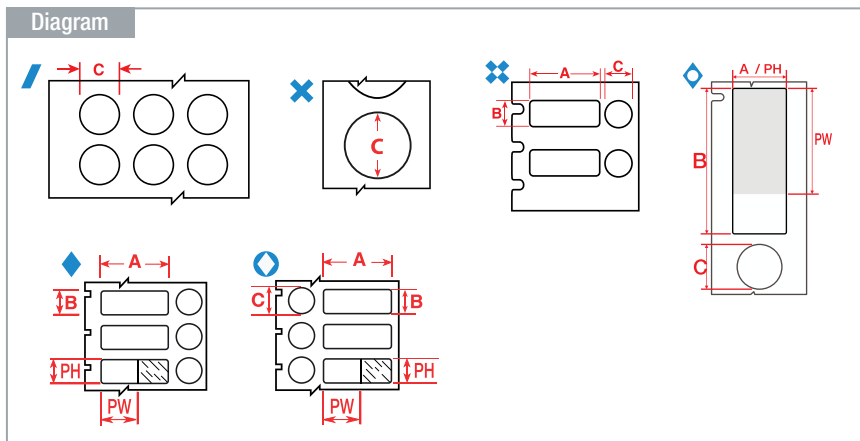

The background colours in the Order Reference column represent the material colour.

See page 58 for Brady's range of label printers.

Labels are shown per vial / tube size and in order of label width.

| Diagram             | Material | Special Properties | Label Width A (mm) | Label Height B (mm) | Diameter C (mm) | Printable Area Width PW (mm) | Printable Area Height PH (mm) | Order Reference   | Printer Compatibility | Printer Ribbon Series | Labels per Roll | Labels per Row |
|---------------------|----------|--------------------|--------------------|---------------------|-----------------|------------------------------|-------------------------------|-------------------|-----------------------|-----------------------|-----------------|----------------|
| <b>1.0 - 2.0 ml</b> |          |                    |                    |                     |                 |                              |                               |                   |                       |                       |                 |                |
| ◇                   | B-461    | <b>F A H S L</b>   | 15.24              | 41.28               | 12.70           | 15.24                        | 30.00                         | M7-116-461        | M710                  | R6200                 | 150             | 1              |
| ✖                   | B-492    | <b>F H L</b>       | 22.86              | 12.70               | 12.70           | -                            | -                             | M6-117-492        | M610, M611            | R4300, R6400          | 500             | 1              |
| ◇                   | B-494    | <b>F N H</b>       | 25.40              | 9.53                | 9.53            | -                            | -                             | B33-304-494-BL    | i3300, i5300          | R6400                 | 1500            | 1              |
| ◇                   | B-494    | <b>F N H</b>       | 25.40              | 9.53                | 9.53            | -                            | -                             | B33-304-494-GN    | i3300, i5300          | R6400                 | 1500            | 1              |
| ◇                   | B-494    | <b>F N H</b>       | 25.40              | 9.53                | 9.53            | -                            | -                             | B33-304-494-OR    | i3300, i5300          | R6400                 | 1500            | 1              |
| ◇                   | B-494    | <b>F N H</b>       | 25.40              | 9.53                | 9.53            | -                            | -                             | B33-304-494-PK    | i3300, i5300          | R6400                 | 1500            | 1              |
| ◇                   | B-494    | <b>F N H</b>       | 25.40              | 9.53                | 9.53            | -                            | -                             | B33-304-494-RD    | i3300, i5300          | R6400                 | 1500            | 1              |
| ◇                   | B-494    | <b>F N H</b>       | 25.40              | 9.53                | 9.53            | -                            | -                             | B33-304-494-YL    | i3300, i5300          | R6400                 | 1500            | 1              |
| ✖                   | B-499    | <b>F A</b>         | 25.40              | 9.53                | 9.53            | -                            | -                             | B33-163-499       | i3300                 | B30 Monocolour Series | 1500            | 1              |
| ✖                   | B-492    | <b>F H L</b>       | 25.40              | 9.53                | 9.53            | -                            | -                             | B33-163-492       | i3300                 | B30 Monocolour Series | 1500            | 1              |
| ✖                   | B-499    | <b>F A</b>         | 25.40              | 9.53                | 9.53            | -                            | -                             | M-118-499         | BMP51                 | R4300                 | 240             | -              |
| ✖                   | B-492    | <b>F H L</b>       | 25.40              | 9.53                | 9.53            | -                            | -                             | M-118-492         | BMP51                 | R6400                 | 240             | -              |
| ◇                   | B-494    | <b>F N H</b>       | 25.40              | 9.53                | 9.53            | -                            | -                             | THT-304-494-3-BL  | i5100, i7100          | R6400                 | 3000            | 1              |
| ◇                   | B-494    | <b>F N H</b>       | 25.40              | 9.53                | 9.53            | -                            | -                             | THT-304-494-3-GN  | i5100, i7100          | R6400                 | 3000            | 1              |
| ◇                   | B-494    | <b>F N H</b>       | 25.40              | 9.53                | 9.53            | -                            | -                             | THT-304-494-3-OR  | i5100, i7100          | R6400                 | 3000            | 1              |
| ◇                   | B-494    | <b>F N H</b>       | 25.40              | 9.53                | 9.53            | -                            | -                             | THT-304-494-3-PK  | i5100, i7100          | R6400                 | 3000            | 1              |
| ◇                   | B-494    | <b>F N H</b>       | 25.40              | 9.53                | 9.53            | -                            | -                             | THT-304-494-3-RD  | i5100, i7100          | R6400                 | 3000            | 1              |
| ◇                   | B-494    | <b>F N H</b>       | 25.40              | 9.53                | 9.53            | -                            | -                             | THT-304-494-3-YL  | i5100, i7100          | R6400                 | 3000            | 1              |
| ✖                   | B-499    | <b>F A</b>         | 25.40              | 9.53                | 9.53            | -                            | -                             | THT-163-499-3     | i7100, i5100          | R4900                 | 3000            | 1              |
| ✖                   | B-492    | <b>F H L</b>       | 25.40              | 9.53                | 9.53            | -                            | -                             | THT-163-492-3     | BBP12, i7100, i5100   | R6400                 | 3000            | 1              |
| ✖                   | B-492    | <b>F H L</b>       | 25.40              | 12.70               | 9.53            | -                            | -                             | M7-118-492        | M710                  | R6400                 | 500             | 1              |
| ✖                   | B-492    | <b>F H L</b>       | 25.40              | 12.70               | 9.53            | -                            | -                             | THT-181-492-3     | i7100, i5100          | R6400                 | 3000            | 1              |
| ✖                   | B-492    | <b>F H L</b>       | 25.40              | 12.70               | 11.18           | -                            | -                             | B33-182-492       | i3300                 | B30 Monocolour Series | 1500            | 1              |
| ◇                   | B-494    | <b>F N H</b>       | 25.40              | 12.70               | 11.18           | -                            | -                             | THT-306-494-3-BL  | i5100, i7100          | R6400                 | 3000            | 1              |
| ◇                   | B-494    | <b>F N H</b>       | 25.40              | 12.70               | 11.18           | -                            | -                             | THT-306-494-3-GN  | i5100, i7100          | R6400                 | 3000            | 1              |
| ◇                   | B-494    | <b>F N H</b>       | 25.40              | 12.70               | 11.18           | -                            | -                             | THT-306-494-3-OR  | i5100, i7100          | R6400                 | 3000            | 1              |
| ◇                   | B-494    | <b>F N H</b>       | 25.40              | 12.70               | 11.18           | -                            | -                             | THT-306-494-3-PK  | i5100, i7100          | R6400                 | 3000            | 1              |
| ◇                   | B-494    | <b>F N H</b>       | 25.40              | 12.70               | 11.18           | -                            | -                             | THT-306-494-3-RD  | i5100, i7100          | R6400                 | 3000            | 1              |
| ◇                   | B-494    | <b>F N H</b>       | 25.40              | 12.70               | 11.18           | -                            | -                             | THT-306-494-3-YL  | i5100, i7100          | R6400                 | 3000            | 1              |
| ✖                   | B-492    | <b>F H L</b>       | 25.40              | 12.70               | 11.18           | -                            | -                             | THT-182-492-3     | BBP12, i7100, i5100   | R6400                 | 3000            | 1              |
| ◇                   | B-461    | <b>F A H S L</b>   | 40.00              | 15.00               | 9.00            | 40.00                        | 15.00                         | BPTLAB-20-461-2.5 | BBP12                 | R7950                 | 2500            | 1              |
| ◇                   | B-461    | <b>F A H S L</b>   | 40.00              | 15.00               | 9.53            | 29.97                        | 15.00                         | M7-101-461        | M710                  | R6200                 | 250             | 1              |
| ◇                   | B-461    | <b>F A H S L</b>   | 41.28              | 15.24               | 12.70           | 41.28                        | 15.24                         | B33-608-461       | i3300                 | B30-R4300             | 1000            | 1              |
| ◇                   | B-461    | <b>F A H S L</b>   | 41.28              | 15.24               | 12.70           | 41.28                        | 15.24                         | BPT-608-461       | BBP12                 | R7950                 | 1000            | 1              |
| ✖                   | B-499    | <b>F A</b>         | 41.28              | 15.24               | 12.70           | -                            | -                             | BPT-608-499       | BBP12                 | R7950                 | 1000            | 1              |
| /                   | B-499    | <b>F A</b>         | -                  | -                   | 12.70           | -                            | -                             | B33-144-499       | i3300                 | B30 Monocolour Series | 1500            | 3              |
| /                   | B-492    | <b>F H L</b>       | -                  | -                   | 12.70           | -                            | -                             | B33-144-492       | i3300                 | B30 Monocolour Series | 1500            | 3              |

\*\*AW = All White / no transparent area.

>>

**F** Freezer environment **N** Liquid nitrogen environment **A** Autoclave environment **H** Hot water bath (100°C) **S** Self-laminating label **L** Low-profile (extremely thin) label **R** Removable

# Vial Top Labels

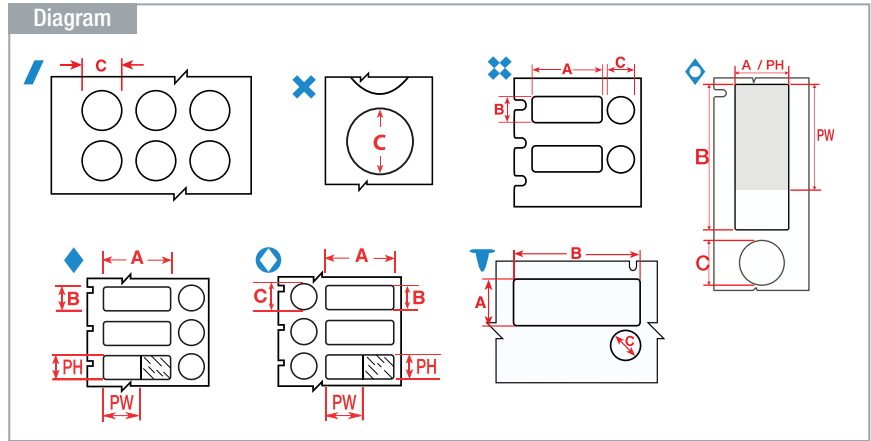

Labels are shown per vial / tube size and in order of label width.

The background colours in the Order Reference column represent the material colour.

See page 58 for Brady's range of label printers.

| Diagram             | Material | Special Properties | Label Width A (mm) | Label Height B (mm) | Diameter C (mm) | Printable Area Width PW (mm) | Printable Area Height PH (mm) | Order Reference    | Printer Compatibility | Printer Ribbon Series | Labels per Roll | Labels per Row |
|---------------------|----------|--------------------|--------------------|---------------------|-----------------|------------------------------|-------------------------------|--------------------|-----------------------|-----------------------|-----------------|----------------|
| <b>1.0 - 2.0 ml</b> |          |                    |                    |                     |                 |                              |                               |                    |                       |                       |                 |                |
| /                   | B-490    | F H L              | -                  | -                   | 12.70           | -                            | -                             | B33-144-490        | i3300                 | B30 Monocolour Series | 2500            | 3              |
| X                   | B-499    | F A                | -                  | -                   | 12.70           | -                            | -                             | M7-83-499          | M710                  | R4300, R6000HF, R6200 | 500             | 1              |
| /                   | B-499    | F A                | -                  | -                   | 12.70           | -                            | -                             | THT-144-499-3      | BBP12, i7100, i5100   | R4900                 | 3000            | 3              |
| /                   | B-499    | F A                | -                  | -                   | 12.70           | -                            | -                             | THT-144-499-1.5-SC | BBP12                 | R7950, R4300, R4900   | 1500            | 3              |
| /                   | B-492    | F H L              | -                  | -                   | 12.70           | -                            | -                             | THT-144-492-3      | BBP12, i7100, i5100   | R6400                 | 3000            | 3              |
| /                   | B-492    | F H L              | -                  | -                   | 12.70           | -                            | -                             | THT-144-492-1.5-SC | BBP12                 | R6400                 | 1500            | 3              |
| <b>1.0 - 8.0 ml</b> |          |                    |                    |                     |                 |                              |                               |                    |                       |                       |                 |                |
| ⊠                   | B-499    | F A                | 22.86              | 12.70               | 12.70           | -                            | -                             | B33-126-499        | i3300                 | B30 Monocolour Series | 1500            | 1              |
| ⊠                   | B-490    | F H L              | 22.86              | 12.70               | 12.70           | -                            | -                             | B33-126-490        | i3300                 | B30 Monocolour Series | 2500            | 1              |
| ⊠                   | B-499    | F A                | 22.86              | 12.70               | 12.70           | -                            | -                             | M7-126-499         | M710                  | R4300                 | 500             | 1              |
| ⊠                   | B-499    | F A                | 22.86              | 12.70               | 12.70           | -                            | -                             | THT-126-499-3      | i7100, i5100          | R4900                 | 3000            | 1              |
| ◇                   | B-494    | F N H              | 25.40              | 9.53                | 9.53            | 25.40                        | 6.35                          | M6-98-494-BL       | M611, M610            | R6400                 | 500             | 1              |
| ◇                   | B-494    | F N H              | 25.40              | 9.53                | 9.53            | 25.40                        | 6.35                          | M6-98-494-GN       | M611, M610            | R6400                 | 500             | 1              |
| ◇                   | B-494    | F N H              | 25.40              | 9.53                | 9.53            | 25.40                        | 6.35                          | M6-98-494-OR       | M611, M610            | R6400                 | 500             | 1              |
| ◇                   | B-494    | F N H              | 25.40              | 9.53                | 9.53            | 25.40                        | 6.35                          | M6-98-494-PK       | M611, M610            | R6400                 | 500             | 1              |
| ◇                   | B-494    | F N H              | 25.40              | 9.53                | 9.53            | 25.40                        | 6.35                          | M6-98-494-RD       | M611, M610            | R6400                 | 500             | 1              |
| ◇                   | B-494    | F N H              | 25.40              | 9.53                | 9.53            | 25.40                        | 6.35                          | M6-98-494-YL       | M611, M610            | R6400                 | 500             | 1              |
| ⊠                   | B-492    | F H L              | 41.28              | 15.24               | 9.53            | -                            | -                             | B33-190-492        | i3300                 | B30 Monocolour Series | 1500            | 1              |
| ⊠                   | B-492    | F H L              | 41.28              | 15.24               | 9.53            | -                            | -                             | THT-190-492-3      | BBP12, i7100, i5100   | R6400                 | 3000            | 1              |
| <b>1.5 - 2.0 ml</b> |          |                    |                    |                     |                 |                              |                               |                    |                       |                       |                 |                |
| ⊠                   | B-499    | F A                | 22.86              | 12.70               | 11.18           | -                            | -                             | M-117-499          | BMP51                 | R4300                 | 240             | -              |
| ⊠                   | B-492    | F H L              | 22.86              | 12.70               | 11.18           | -                            | -                             | M-117-492          | BMP51                 | R6400                 | 240             | -              |
| ◇                   | B-494    | F N H              | 25.40              | 12.70               | 9.53            | 25.40                        | 9.53                          | B33-250-494-BL     | i3300, i5300          | B30 Monocolour Series | 1500            | 1              |
| ◇                   | B-494    | F N H              | 25.40              | 12.70               | 9.53            | 25.40                        | 9.53                          | B33-250-494-GN     | i3300, i5300          | B30 Monocolour Series | 1500            | 1              |
| ◇                   | B-494    | F N H              | 25.40              | 12.70               | 9.53            | 25.40                        | 9.53                          | B33-250-494-OR     | i3300, i5300          | B30 Monocolour Series | 1500            | 1              |
| ◇                   | B-494    | F N H              | 25.40              | 12.70               | 9.53            | 25.40                        | 9.53                          | B33-250-494-PK     | i3300, i5300          | B30 Monocolour Series | 1500            | 1              |
| ◇                   | B-494    | F N H              | 25.40              | 12.70               | 9.53            | 25.40                        | 9.53                          | B33-250-494-RD     | i3300, i5300          | B30 Monocolour Series | 1500            | 1              |
| ◇                   | B-494    | F N H              | 25.40              | 12.70               | 9.53            | 25.40                        | 9.53                          | B33-250-494-YL     | i3300, i5300          | B30 Monocolour Series | 1500            | 1              |
| ⊠                   | B-499    | F A                | 25.40              | 12.70               | 9.53            | -                            | -                             | M-120-499          | BMP51                 | R4300                 | 240             | -              |
| ⊠                   | B-492    | F H L              | 25.40              | 12.70               | 9.53            | -                            | -                             | M-120-492          | BMP51                 | R6400                 | 240             | -              |
| ▽                   | B-492    | F H L              | 41.28              | 15.24               | 9.53            | -                            | -                             | M-95-492           | BMP51                 | R6400                 | 200             | -              |
| X                   | B-499    | F A                | -                  | -                   | 12.70           | -                            | -                             | M-83-499           | BMP41, BMP51          | R4300                 | 240             | -              |
| X                   | B-499    | F A                | -                  | -                   | 12.70           | -                            | -                             | M-83-499-OR-BK     | BMP41, BMP51          | R4300                 | 240             | -              |
| X                   | B-499    | F A                | -                  | -                   | 12.70           | -                            | -                             | M-83-499-RD-BK     | BMP41, BMP51          | R4300                 | 240             | -              |
| X                   | B-499    | F A                | -                  | -                   | 12.70           | -                            | -                             | M-83-499-YL-BK     | BMP41, BMP51          | R4300                 | 240             | -              |
| X                   | B-492    | F H L              | -                  | -                   | 12.70           | -                            | -                             | M-83-492           | BMP41, BMP51          | R6400                 | 240             | -              |

## Centrifuge / Microcentrifuge Labels

Brady offers a wide range of Centrifuge, Eppendorf and PCR Labels.

When applying a self-laminating label, we recommend you avoid touching the adhesive side of the label when wrapping it around a vial or tube, to ensure maximum adhesion.

- F** Freezer environment
- N** Liquid nitrogen environment
- A** Autoclave environment
- H** Hot water bath (100°C)
- S** Self-laminating label
- L** Low-profile (extremely thin) label
- R** Removable

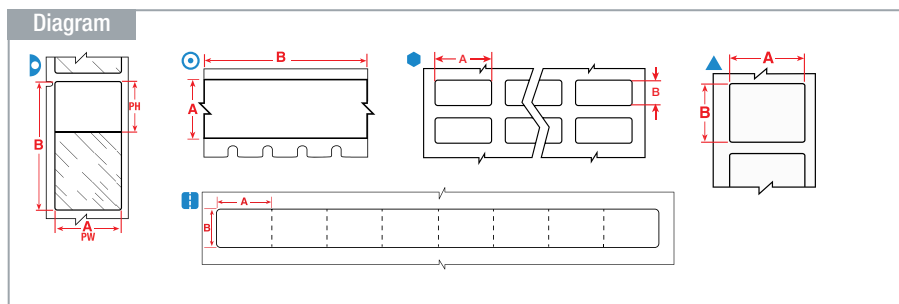

Labels are shown per vial / tube size and in order of label width.

The background colours in the Order Reference column represent the material colour.

See page 58 for Brady's range of label printers.

| Diagram             | Material | Special Properties | Label Width A (mm) | Label Height B (mm) | Label Length B (m) | Diameter C (mm) | Printable Area Width PW (mm) | Printable Area Height PH (mm) | Order Reference  | Printer Compatibility | Printer Ribbon Series | Labels per Roll | Labels per Row |
|---------------------|----------|--------------------|--------------------|---------------------|--------------------|-----------------|------------------------------|-------------------------------|------------------|-----------------------|-----------------------|-----------------|----------------|
| <b>0.2 ml</b>       |          |                    |                    |                     |                    |                 |                              |                               |                  |                       |                       |                 |                |
|                     | B-461    | <b>FNAHSL</b>      | 38.10              | 4.75                | –                  | –               | 17.78                        | 4.75                          | M6-108-461       | M610, M611            | R4300                 | 750             | 1              |
|                     | B-492    | <b>FHL</b>         | 9.50               | 6.35                | –                  | –               | –                            | –                             | B33-289-492-WT   | i3300                 | R6400                 | 1500            | 8              |
|                     | B-492    | <b>FHL</b>         | 9.50               | 6.35                | –                  | –               | –                            | –                             | THT-289-492-2-WT | BBP12, i7100, i5100   | R6400                 | 2000            | 8              |
| <b>0.5 ml</b>       |          |                    |                    |                     |                    |                 |                              |                               |                  |                       |                       |                 |                |
|                     | B-461    | <b>FNAHSL</b>      | 6.35               | 27.94               | –                  | –               | 6.35                         | 22.09                         | B33-627-461*     | i3300                 | B30-R4300             | 1000            | 1              |
|                     | B-461    | <b>FNAHSL</b>      | 6.35               | 27.94               | –                  | –               | 6.35                         | 22.09                         | BPT-627-461*     | BBP12                 | R7950                 | 1000            | 1              |
|                     | B-423    | <b>FAH</b>         | 6.35               | –                   | 6.40               | –               | –                            | –                             | M21-250-423      | M210-LAB, M211        | R6200                 | 1               | –              |
|                     | B-427    | <b>FN S</b>        | 25.40              | 63.50               | –                  | –               | 25.40                        | 19.05                         | M6-21-427        | M611, M610, M710      | R4300, R6200, R4400   | 100             | 1              |
| <b>0.5 - 0.7 ml</b> |          |                    |                    |                     |                    |                 |                              |                               |                  |                       |                       |                 |                |
|                     | B-461    | <b>FNAHSL</b>      | 5.08               | 22.86               | –                  | –               | 5.08                         | 18.03                         | BPT-614-461*     | BBP12                 | R7950                 | 2000            | 1              |
|                     | B-461    | <b>FNAHSL</b>      | 5.08               | 22.86               | –                  | –               | 5.08                         | 18.29                         | B33-614-461*     | i3300                 | B30-R4300             | 2000            | 1              |
|                     | B-498    | <b>FR</b>          | 9.53               | 25.40               | –                  | –               | –                            | –                             | M6-16-498        | M610, M611            | R6600, R6200          | 500             | 1              |
|                     | B-499    | <b>FNA</b>         | 9.53               | 25.40               | –                  | –               | –                            | –                             | M6-16-499        | M610, M611            | R4300, R6000HF, R6200 | 500             | 1              |
|                     | B-498    | <b>FR</b>          | 9.53               | 25.40               | –                  | –               | –                            | –                             | M7-16-498        | M710                  | R6200                 | 500             | 1              |
|                     | B-499    | <b>FNA</b>         | 9.53               | 25.40               | –                  | –               | –                            | –                             | M7-16-499        | M710                  | R4300                 | 500             | 1              |
|                     | B-461    | <b>FNAHSL</b>      | 9.53               | 45.72               | –                  | –               | 9.53                         | 19.05                         | M7-73-461        | M710                  | R6200                 | 250             | 1              |
|                     | B-427    | <b>FN S</b>        | 12.70              | 19.05               | –                  | –               | 12.70                        | 9.53                          | M21-11-427       | M210-LAB, M211        | R4300, R4500          | 1               | 1              |
|                     | B-490    | <b>FNHL</b>        | 12.70              | 19.05               | –                  | –               | –                            | –                             | B33-68-490       | i3300                 | B30 Monocolour        | 2500            | 4              |
|                     | B-499    | <b>FNA</b>         | 12.70              | 19.05               | –                  | –               | –                            | –                             | B33-68-499       | i3300                 | B30 Monocolour        | 1500            | 4              |
|                     | B-498    | <b>FR</b>          | 12.70              | 19.05               | –                  | –               | –                            | –                             | BM-11-498        | M610, M611, M710      | R6200                 | 5000            | 1              |
|                     | B-499    | <b>FNA</b>         | 12.70              | 19.05               | –                  | –               | –                            | –                             | BM-11-499        | M610, M611, M710      | R4300, R6000HF        | 5000            | 1              |
|                     | B-498    | <b>FR</b>          | 12.70              | 19.05               | –                  | –               | –                            | –                             | M6-11-498        | M610, M611            | R6200                 | 500             | 1              |
|                     | B-499    | <b>FNA</b>         | 12.70              | 19.05               | –                  | –               | –                            | –                             | M6-11-499        | M610, M611            | R4300, R6000HF, R6200 | 500             | 1              |
|                     | B-498    | <b>FR</b>          | 12.70              | 19.05               | –                  | –               | –                            | –                             | M7-11-498        | M710                  | R6200                 | 500             | 1              |
|                     | B-499    | <b>FNA</b>         | 12.70              | 19.05               | –                  | –               | –                            | –                             | M7-11-499        | M710                  | R4300                 | 500             | 1              |
|                     | B-499    | <b>FNA</b>         | 12.70              | 19.05               | –                  | –               | –                            | –                             | THT-68-499-10    | BBP12, i7100, i5100   | R4900                 | 10000           | 4              |
|                     | B-427    | <b>FN S</b>        | 12.70              | 55.88               | –                  | –               | 12.70                        | 19.05                         | THT-127-427-3*   | BBP12, i7100, i5100   | R4300, R7950          | 3000            | 1              |
|                     | B-499    | <b>FNA</b>         | 19.05              | 12.70               | –                  | –               | –                            | –                             | M-11-499         | BMP41, BMP51          | R4300                 | 220             | –              |
|                     | B-499    | <b>FNA</b>         | 19.05              | 12.70               | –                  | –               | –                            | –                             | M21-11-499       | M210-LAB, M211        | R4300                 | 1               | 1              |
|                     | B-7425   | <b>FNAH</b>        | 25.40              | 9.53                | –                  | 9.53            | –                            | –                             | M-118-7425       | BMP41, BMP51          | R4300                 | 240             | 1              |

\*Label is rotated 90° on liner.

>>

▶ These labels are also suitable for Eppendorf tubes and PCR process.

# Centrifuge / Microcentrifuge Labels

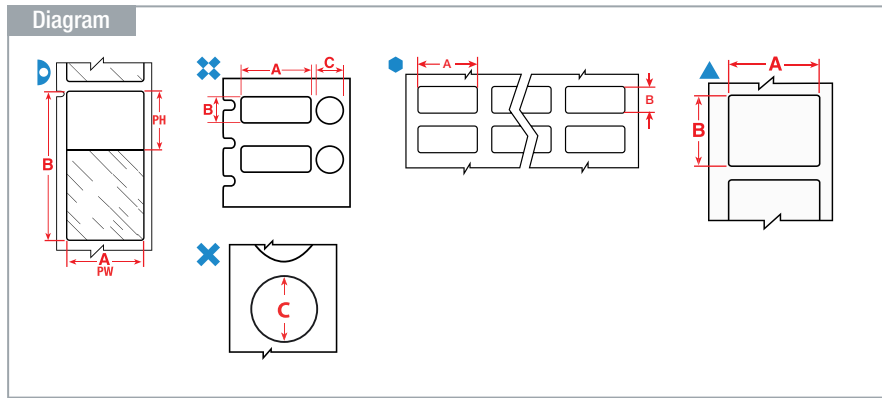
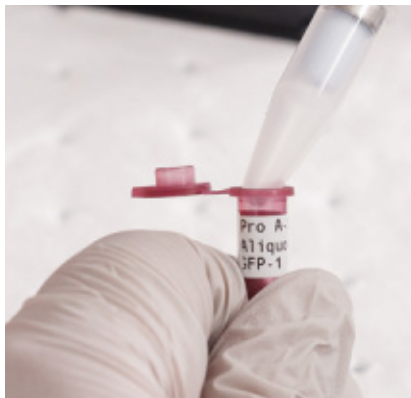

Labels are shown per vial / tube size and in order of label width.

The background colours in the Order Reference column represent the material colour.

See page 58 for Brady's range of label printers.

| Diagram             | Material | Special Properties | Label Width A (mm) | Label Height B (mm) | Label Length B (m) | Diameter C (mm) | Printable Area Width PW (mm) | Printable Area Height PH (mm) | Order Reference      | Printer Compatibility | Printer Ribbon Series | Labels per Roll | Labels per Row |
|---------------------|----------|--------------------|--------------------|---------------------|--------------------|-----------------|------------------------------|-------------------------------|----------------------|-----------------------|-----------------------|-----------------|----------------|
| <b>0.5 - 0.7 ml</b> |          |                    |                    |                     |                    |                 |                              |                               |                      |                       |                       |                 |                |
| ❖                   | B-499    | <b>F A</b>         | 25.40              | 9.53                | -                  | 9.53            | -                            | -                             | M7-98-499            | M710                  | R4300                 | 500             | 1              |
| ⬢                   | B-499    | <b>F N A</b>       | 25.40              | 9.53                | -                  | -               | -                            | -                             | B33-152-499          | i3300                 | B30 Monocolour        | 1500            | 2              |
| ▲                   | B-492    | <b>F N H L</b>     | 25.40              | 9.53                | -                  | -               | -                            | -                             | M7-16-492            | M710                  | R6400                 | 500             | 1              |
| ⬢                   | B-492    | <b>F N H L</b>     | 25.40              | 9.53                | -                  | -               | -                            | -                             | THT-152-492-2.5-SC   | BBP12                 | R6400                 | 2500            | 2              |
| ⬢                   | B-492    | <b>F N H L</b>     | 25.40              | 9.53                | -                  | -               | -                            | -                             | THT-152-492-3        | BBP12, i7100, i5100   | R6400                 | 3000            | 2              |
| ⬢                   | B-499    | <b>F N A</b>       | 25.40              | 9.53                | -                  | -               | -                            | -                             | THT-152-499-1.5-SC   | BBP12                 | R7950, R4300, R4900   | 1500            | 2              |
| ⬢                   | B-499    | <b>F N A</b>       | 25.40              | 9.53                | -                  | -               | -                            | -                             | THT-152-499-3        | BBP12, i7100, i5100   | R4900                 | 3000            | 2              |
| ⬢                   | B-7600   | <b>F N H L</b>     | 25.40              | 9.53                | -                  | -               | -                            | -                             | THT-301-7600-2.5SC   | BBP12                 | R6000HF               | 2500            | 2              |
| ⬢                   | B-7600   | <b>F N H L</b>     | 25.40              | 9.53                | -                  | -               | -                            | -                             | THT-301-7600-3       | BBP12, i7100, i5100   | R6000HF               | 3000            | 2              |
| ⬢                   | B-425A   | <b>F</b>           | 25.40              | 10.00               | -                  | -               | -                            | -                             | THT-30-425-10        | BBP12, i7100, i5100   | R6400                 | 10000           | 3              |
| ⬢                   | B-461    | <b>F N A H S L</b> | 28.58              | 9.53                | -                  | -               | 19.05                        | 9.53                          | M-123-461*           | BMP51                 | R4300                 | 360             | -              |
| ⬢                   | B-461    | <b>F N A H S L</b> | 28.58              | 12.70               | -                  | -               | 19.05                        | 12.70                         | M-122-461            | BMP51                 | R4300                 | 360             | -              |
| ▲                   | B-490    | <b>F N H L</b>     | 31.75              | 9.53                | -                  | -               | -                            | -                             | B33-154-490          | i3300                 | B30 Monocolour        | 1500            | 1              |
| ▲                   | B-490    | <b>F N H L</b>     | 31.75              | 9.53                | -                  | -               | -                            | -                             | M-112-490            | BMP51                 | R4300                 | 360             | -              |
| ▲                   | B-492    | <b>F N H L</b>     | 31.75              | 9.53                | -                  | -               | -                            | -                             | M-112-492            | BMP51                 | R6400                 | 360             | -              |
| ▲                   | B-490    | <b>F N H L</b>     | 31.75              | 9.53                | -                  | -               | -                            | -                             | M6-112-490           | M610, M611            | R4300                 | 500             | 1              |
| ▲                   | B-490    | <b>F N H L</b>     | 31.75              | 9.53                | -                  | -               | -                            | -                             | THT-154-490-1.5-SC   | BBP12                 | R7950                 | 1500            | 1              |
| ▲                   | B-490    | <b>F N H L</b>     | 31.75              | 9.53                | -                  | -               | -                            | -                             | THT-154-490-3        | BBP12, i7100, i5100   | R4300                 | 3000            | 1              |
| ⬢                   | B-461    | <b>F N A H S L</b> | 41.91              | 12.70               | -                  | -               | 19.05                        | 12.70                         | M6-202-461           | M610, M611            | R4300, R6200          | 500             | 1              |
| ⬢                   | B-461    | <b>F N A H S L</b> | 44.45              | 12.70               | -                  | -               | 19.05                        | 12.70                         | M-72-461             | BMP41, BMP51          | R4300                 | 180             | -              |
| ⬢                   | B-461    | <b>F N A H S L</b> | 45.72              | 9.53                | -                  | -               | 12.70                        | 9.53                          | B33-123-461*         | i3300                 | B30 Monocolour        | 1500            | 1              |
| ⬢                   | B-461    | <b>F N A H S L</b> | 45.72              | 9.53                | -                  | -               | 19.05                        | 9.53                          | M6-73-461            | M610, M611            | R4300                 | 500             | 1              |
| ⬢                   | B-461    | <b>F N A H S L</b> | 45.72              | 9.53                | -                  | -               | 19.05                        | 9.53                          | THT-123-461*-1.5-SC* | BBP12                 | R7950                 | 1500            | 1              |
| ⬢                   | B-461    | <b>F N A H S L</b> | 45.72              | 9.53                | -                  | -               | 19.05                        | 9.53                          | THT-123-461*-3*      | BBP12, i7100, i5100   | R4300, R7950          | 3000            | 1              |
| ⬢                   | B-461    | <b>F N A H S L</b> | 45.72              | 12.70               | -                  | -               | 12.70                        | 12.70                         | B33-122-461          | i3300                 | B30 Monocolour        | 1500            | 1              |
| ⬢                   | B-461    | <b>F N A H S L</b> | 45.72              | 12.70               | -                  | -               | 19.05                        | 12.70                         | M6-72-461            | M610, M611            | R4300                 | 500             | 1              |
| ⬢                   | B-461    | <b>F N A H S L</b> | 45.72              | 12.70               | -                  | -               | 19.05                        | 12.70                         | THT-122-461-1.5-SC*  | BBP12                 | R7950                 | 1500            | 1              |
| ⬢                   | B-461    | <b>F N A H S L</b> | 45.72              | 12.70               | -                  | -               | 19.05                        | 12.70                         | THT-122-461-3*       | BBP12, i7100, i5100   | R4300, R7950          | 3000            | 1              |
| ⬢                   | B-461    | <b>F N A H S L</b> | 45.72              | 15.24               | -                  | -               | 25.40                        | 15.24                         | M6-201-461           | M610, M611            | R4300, R6200          | 100             | 1              |
| ⬢                   | B-461    | <b>F N A H S L</b> | 55.88              | 12.70               | -                  | -               | 19.05                        | 12.70                         | THT-127-461-1.5-SC*  | BBP12                 | R7950                 | 1500            | 1              |
| ⬢                   | B-461    | <b>F N A H S L</b> | 55.88              | 12.70               | -                  | -               | 19.05                        | 12.70                         | THT-127-461-3*       | BBP12, i7100, i5100   | R4300, R7950          | 3000            | 1              |
| ⬢                   | B-461    | <b>F N A H S L</b> | 55.88              | 12.70               | -                  | -               | 55.88                        | 12.70                         | B33-127-461          | i3300                 | B30 Monocolour        | 1500            | 3              |
| <b>0.5 - 1.5 ml</b> |          |                    |                    |                     |                    |                 |                              |                               |                      |                       |                       |                 |                |
| ❖                   | B-492    | <b>F H L</b>       | -                  | -                   | -                  | 9.53            | -                            | -                             | M-82-492             | BMP41, BMP51          | R6400                 | 240             | -              |
| ❖                   | B-499    | <b>F A</b>         | -                  | -                   | -                  | 9.53            | -                            | -                             | M-82-499-RD-BK       | BMP41, BMP51          | R4300                 | 240             | -              |
| <b>0.5 - 2.0 ml</b> |          |                    |                    |                     |                    |                 |                              |                               |                      |                       |                       |                 |                |
| ⬢                   | B-427    | <b>F N S</b>       | 12.70              | 55.88               | -                  | -               | 12.70                        | 19.05                         | M6-74-427            | M610, M611            | R4300                 | 100             | 1              |
| ⬢                   | B-461    | <b>F N A H S L</b> | 55.88              | 12.70               | -                  | -               | 19.05                        | 12.70                         | M6-74-461            | M610, M611            | R4300                 | 100             | 1              |
| ⬢                   | B-461    | <b>F N A H S L</b> | 63.50              | 38.10               | -                  | -               | 19.05                        | 38.10                         | M6-157-461           | M610, M611            | R4300                 | 100             | 1              |

\*Label is rotated 90° on liner.

>>>

▶ These labels are also suitable for Eppendorf tubes and PCR process.

Diagram

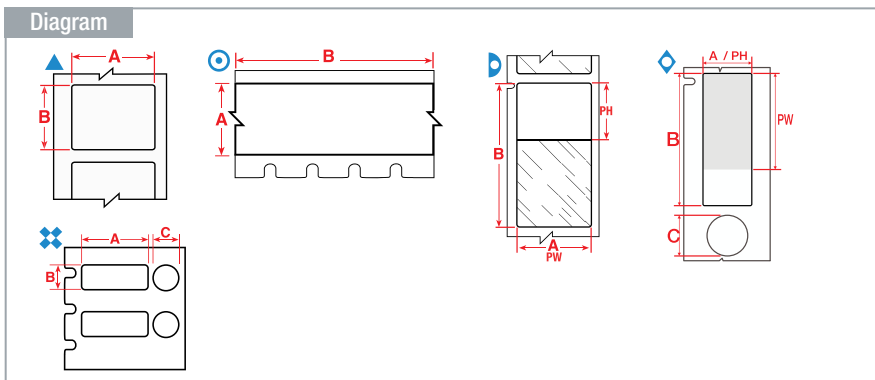

The background colours in the Order Reference column represent the material colour.

See page 58 for Brady's range of label printers.

Labels are shown per vial / tube size and in order of label width.

| Diagram             | Material | Special Properties | Label Width A (mm) | Label Height B (mm) | Label Length B (m) | Diameter C (mm) | Printable Area Width PW (mm) | Printable Area Height PH (mm) | Order Reference    | Printer Compatibility | Printer Ribbon Series               | Labels per Roll | Labels per Row |
|---------------------|----------|--------------------|--------------------|---------------------|--------------------|-----------------|------------------------------|-------------------------------|--------------------|-----------------------|-------------------------------------|-----------------|----------------|
| <b>0.5 - 8.0 ml</b> |          |                    |                    |                     |                    |                 |                              |                               |                    |                       |                                     |                 |                |
| ✘                   | B-7600   | <b>F N H L</b>     | 25.40              | 9.53                | -                  | 9.53            | -                            | -                             | THT-307-7600-1.5SC | BBP12                 | R6000HF                             | 1500            | 1              |
| ✘                   | B-7600   | <b>F N H L</b>     | 25.40              | 12.70               | -                  | 9.53            | -                            | -                             | THT-308-7600-1.5SC | BBP12                 | R6000HF                             | 1500            | 1              |
| ✘                   | B-7600   | <b>F N H L</b>     | 25.40              | 12.70               | -                  | 11.18           | -                            | -                             | THT-309-7600-1.5SC | BBP12                 | R6000HF                             | 1500            | 1              |
| ▲                   | B-499    | <b>F N A</b>       | 25.40              | 12.70               | -                  | -               | -                            | -                             | M21-131-499        | M210-LAB, M211        | R4300                               | 1               | 1              |
| ▲                   | B-423    | <b>F A H</b>       | 25.40              | 12.70               | -                  | -               | -                            | -                             | M21-17-423         | M210-LAB, M211        | R6000HF                             | 1               | 1              |
| <b>0.6 ml</b>       |          |                    |                    |                     |                    |                 |                              |                               |                    |                       |                                     |                 |                |
| ▲                   | B-492    | <b>F N H L</b>     | 9.53               | 20.96               | -                  | -               | -                            | -                             | M-130-492          | BMP41, BMP51          | R6400                               | 220             | -              |
| ▲                   | B-499    | <b>F N A</b>       | 9.53               | 20.96               | -                  | -               | -                            | -                             | M-130-499          | BMP41, BMP51          | R4300                               | 220             | -              |
| ○                   | B-499    | <b>F N A</b>       | 9.53               | -                   | 4.88               | -               | -                            | -                             | M21-375-499        | M210-LAB, M211        | R4300                               | 1               | -              |
| ○                   | B-499    | <b>F N A</b>       | 9.53               | -                   | 4.88               | -               | -                            | -                             | MC-375-499         | BMP41, BMP51          | R4300                               | 1               | -              |
| ○                   | B-461    | <b>F N A H S L</b> | 9.53               | -                   | 6.40               | -               | -                            | -                             | M21-375-461-AW**   | M210-LAB, M211        | R4300                               | 1               | -              |
| ▲                   | B-499    | <b>F N A</b>       | 22.86              | 12.70               | -                  | -               | -                            | -                             | M7-84-499          | M710                  | R4300, R4500, R4900, R6000HF, R6200 | 500             | 1              |
| ▲                   | B-499    | <b>F N A</b>       | 22.86              | 12.70               | -                  | -               | -                            | -                             | M-84-499           | BMP51                 | R4300                               | 200             | -              |
| ▲                   | B-492    | <b>F N H L</b>     | 31.75              | 6.35                | -                  | -               | -                            | -                             | M-155-492          | BMP51                 | R6400                               | 180             | -              |
| <b>0.6 - 1.5 ml</b> |          |                    |                    |                     |                    |                 |                              |                               |                    |                       |                                     |                 |                |
| ✘                   | B-492    | <b>F H L</b>       | 15.24              | 41.28               | -                  | 9.53            | -                            | -                             | M6-205-492*        | M610, M611            | R4300, R6400                        | 250             | 1              |
| ✘                   | B-499    | <b>F A</b>         | 25.40              | 9.53                | -                  | 9.53            | -                            | -                             | M6-98-499          | M610, M611            | R4300, R6000HF, R6200               | 500             | 1              |
| <b>1.0 - 2.0 ml</b> |          |                    |                    |                     |                    |                 |                              |                               |                    |                       |                                     |                 |                |
| ✘                   | B-492    | <b>F H L</b>       | 25.40              | 9.53                | -                  | 9.53            | -                            | -                             | M-118-492          | BMP51                 | R6400                               | 240             | -              |
| ✘                   | B-499    | <b>F A</b>         | 25.40              | 9.53                | -                  | 9.53            | -                            | -                             | M-118-499          | BMP51                 | R4300                               | 240             | -              |
| ✘                   | B-7600   | <b>F N H L</b>     | 25.40              | 9.53                | -                  | 9.53            | -                            | -                             | THT-304-7600-3     | BBP12, i7100, i5100   | R6000HF                             | 3000            | 1              |
| ✘                   | B-7600   | <b>F N H L</b>     | 25.40              | 12.70               | -                  | 11.18           | -                            | -                             | THT-306-7600-3     | BBP12, i7100, i5100   | R6000HF                             | 3000            | 1              |
| <b>1.0 - 8.0 ml</b> |          |                    |                    |                     |                    |                 |                              |                               |                    |                       |                                     |                 |                |
| ▲                   | B-492    | <b>F N H L</b>     | 12.70              | 25.40               | -                  | -               | -                            | -                             | M-131-492          | BMP41, BMP51          | R6400                               | 180             | -              |
| ▲                   | B-499    | <b>F N A</b>       | 12.70              | 25.40               | -                  | -               | -                            | -                             | M-131-499          | BMP41, BMP51          | R4300                               | 180             | -              |
| ▷                   | B-461    | <b>F N A H S L</b> | 15.24              | 41.28               | -                  | -               | 15.24                        | 25.40                         | M7-76-461          | M710                  | R6200                               | 500             | 1              |
| ▷                   | B-461    | <b>F N A H S L</b> | 15.24              | 66.68               | -                  | -               | 15.24                        | 25.40                         | M7-86-461          | M710                  | R6200                               | 100             | 1              |
| ▷                   | B-461    | <b>F N A H S L</b> | 15.24              | 66.68               | -                  | -               | 25.40                        | 15.24                         | M6-86-461          | M610, M611            | R4300                               | 100             | 1              |
| ✘                   | B-499    | <b>F A</b>         | 22.86              | 12.70               | -                  | 12.70           | -                            | -                             | M6-117-499         | M610, M611            | R4300                               | 500             | 1              |
| ✘                   | B-499    | <b>F A</b>         | 22.86              | 12.70               | -                  | 12.70           | -                            | -                             | M7-126-499         | M710                  | R4300                               | 500             | 1              |
| ✘                   | B-499    | <b>F A</b>         | 22.86              | 12.70               | -                  | 12.70           | -                            | -                             | THT-126-499-3      | i7100, i5100          | R4900                               | 3000            | 1              |
| ◇                   | B-494    | <b>F N H</b>       | 25.40              | 9.53                | -                  | 9.53            | 25.40                        | 6.35                          | M6-98-494-BL       | M611, M610            | R6400                               | 500             | 1              |
| ◇                   | B-494    | <b>F N H</b>       | 25.40              | 9.53                | -                  | 9.53            | 25.40                        | 6.35                          | M6-98-494-GN       | M611, M610            | R6400                               | 500             | 1              |
| ◇                   | B-494    | <b>F N H</b>       | 25.40              | 9.53                | -                  | 9.53            | 25.40                        | 6.35                          | M6-98-494-OR       | M611, M610            | R6400                               | 500             | 1              |
| ◇                   | B-494    | <b>F N H</b>       | 25.40              | 9.53                | -                  | 9.53            | 25.40                        | 6.35                          | M6-98-494-PK       | M611, M610            | R6400                               | 500             | 1              |
| ◇                   | B-494    | <b>F N H</b>       | 25.40              | 9.53                | -                  | 9.53            | 25.40                        | 6.35                          | M6-98-494-RD       | M611, M610            | R6400                               | 500             | 1              |
| ◇                   | B-494    | <b>F N H</b>       | 25.40              | 9.53                | -                  | 9.53            | 25.40                        | 6.35                          | M6-98-494-YL       | M611, M610            | R6400                               | 500             | 1              |
| ▷                   | B-427    | <b>F N S</b>       | 25.40              | 19.05               | -                  | -               | 25.40                        | 9.53                          | M21-18-427         | M210-LAB, M211        | R4300, R4500                        | 1               | 1              |
| ▲                   | B-423    | <b>F A H</b>       | 25.40              | 19.05               | -                  | -               | -                            | -                             | M21-18-423         | M210-LAB, M211        | R6000HF                             | 1               | 1              |

\*Label is rotated 90° on liner. \*\*AW = All White / no transparent area.

>>

▶ These labels are also suitable for Eppendorf tubes and PCR process.

**F** Freezer environment **N** Liquid nitrogen environment **A** Autoclave environment **H** Hot water bath (100°C) **S** Self-laminating label **L** Low-profile (extremely thin) label **R** Removable

# Centrifuge / Microcentrifuge Labels

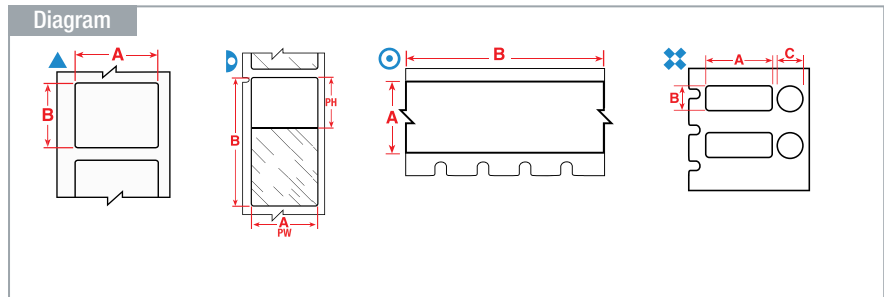

The background colours in the Order Reference column represent the material colour.

See page 58 for Brady's range of label printers.

Labels are shown per vial / tube size and in order of label width.

| Diagram             | Material | Special Properties | Label Width A (mm) | Label Height B (mm) | Label Length B (m) | Diameter C (mm) | Printable Area Width PW (mm) | Printable Area Height PH (mm) | Order Reference     | Printer Compatibility | Printer Ribbon Series | Labels per Roll | Labels per Row |
|---------------------|----------|--------------------|--------------------|---------------------|--------------------|-----------------|------------------------------|-------------------------------|---------------------|-----------------------|-----------------------|-----------------|----------------|
| <b>1.0 - 8.0 ml</b> |          |                    |                    |                     |                    |                 |                              |                               |                     |                       |                       |                 |                |
| ▲                   | B-499    | <b>FNA</b>         | 25.40              | 19.05               | -                  | -               | -                            | -                             | M21-18-499          | M210-LAB, M211        | R4300                 | 1               | 1              |
| ▶                   | B-461    | <b>FNAHSL</b>      | 28.58              | 9.53                | -                  | -               | 19.05                        | 9.53                          | M6-123-461*         | M610, M611            | R4300, R6200          | 500             | 1              |
| ▶                   | B-461    | <b>FNAHSL</b>      | 28.58              | 12.70               | -                  | -               | 19.05                        | 12.70                         | M6-122-461*         | M610, M611            | R4300, R6200          | 500             | 1              |
| ▶                   | B-461    | <b>FNAHSL</b>      | 41.28              | 15.24               | -                  | -               | 25.40                        | 15.24                         | M6-76-461           | M610, M611            | R4300                 | 250             | 1              |
| ▲                   | B-490    | <b>FNHL</b>        | 41.28              | 15.24               | -                  | -               | -                            | -                             | B33-155-490         | i3300                 | B30 Monocolour        | 1500            | 1              |
| ▲                   | B-492    | <b>FNHL</b>        | 41.28              | 15.24               | -                  | -               | -                            | -                             | B33-155-492         | i3300                 | B30 Monocolour        | 1500            | 1              |
| ▲                   | B-494    | <b>FNH</b>         | 41.28              | 15.24               | -                  | -               | -                            | -                             | B33-302-494-BL      | i3300, i5300          | R6400                 | 1500            | 1              |
| ▲                   | B-494    | <b>FNH</b>         | 41.28              | 15.24               | -                  | -               | -                            | -                             | B33-302-494-GN      | i3300, i5300          | R6400                 | 1500            | 1              |
| ▲                   | B-494    | <b>FNH</b>         | 41.28              | 15.24               | -                  | -               | -                            | -                             | B33-302-494-OR      | i3300, i5300          | R6400                 | 1500            | 1              |
| ▲                   | B-494    | <b>FNH</b>         | 41.28              | 15.24               | -                  | -               | -                            | -                             | B33-302-494-PK      | i3300, i5300          | R6400                 | 1500            | 1              |
| ▲                   | B-494    | <b>FNH</b>         | 41.28              | 15.24               | -                  | -               | -                            | -                             | B33-302-494-RD      | i3300, i5300          | R6400                 | 1500            | 1              |
| ▲                   | B-494    | <b>FNH</b>         | 41.28              | 15.24               | -                  | -               | -                            | -                             | B33-302-494-YL      | i3300, i5300          | R6400                 | 1500            | 1              |
| ▲                   | B-490    | <b>FNHL</b>        | 41.28              | 15.24               | -                  | -               | -                            | -                             | M6-76-490           | M610, M611            | R4300                 | 250             | 1              |
| ▲                   | B-490    | <b>FNHL</b>        | 41.28              | 15.24               | -                  | -               | -                            | -                             | M7-76-490           | M710                  | R4300                 | 500             | 1              |
| ▲                   | B-490    | <b>FNHL</b>        | 41.28              | 15.24               | -                  | -               | -                            | -                             | THT-155-490-1.5-SC  | BBP12                 | R7950                 | 1500            | 1              |
| ▲                   | B-490    | <b>FNHL</b>        | 41.28              | 15.24               | -                  | -               | -                            | -                             | THT-155-490-3       | BBP12, i7100, i5100   | R4300, R7950          | 3000            | 1              |
| ▲                   | B-492    | <b>FNHL</b>        | 41.28              | 15.24               | -                  | -               | -                            | -                             | THT-155-492-3       | BBP12, i7100, i5100   | R6400                 | 3000            | 1              |
| ▲                   | B-7600   | <b>FNHL</b>        | 41.28              | 15.24               | -                  | -               | -                            | -                             | THT-302-7600-1.5-SC | BBP12                 | R6000HF               | 1500            | 1              |
| ▲                   | B-7600   | <b>FNHL</b>        | 41.28              | 15.24               | -                  | -               | -                            | -                             | THT-302-7600-3      | BBP12, i7100, i5100   | R6000HF               | 3000            | 1              |
| ▶                   | B-461    | <b>FNAHSL</b>      | 44.45              | 25.40               | -                  | -               | 25.40                        | 25.40                         | M6-203-461          | M610, M611            | R4300, R6200          | 100             | 1              |
| ▶                   | B-461    | <b>FNAHSL</b>      | 45.72              | 15.24               | -                  | -               | 25.40                        | 15.24                         | M-126-461           | BMP41, BMP51          | R4300                 | 180             | -              |
| ▲                   | B-490    | <b>FNHL</b>        | 45.72              | 15.24               | -                  | -               | -                            | -                             | M-126-490           | BMP41, BMP51          | R4300                 | 180             | -              |
| ▲                   | B-7600   | <b>FNHL</b>        | 48.26              | 25.40               | -                  | -               | -                            | -                             | THT-303-7600-1.5-SC | BBP12                 | R6000HF               | 1500            | 1              |
| ▲                   | B-7600   | <b>FNHL</b>        | 48.26              | 25.40               | -                  | -               | -                            | -                             | THT-303-7600-3      | BBP12, i7100, i5100   | R6000HF               | 3000            | 1              |
| ▶                   | B-461    | <b>FNAHSL</b>      | 55.88              | 12.70               | -                  | -               | 19.05                        | 12.70                         | M-74-461            | BMP41, BMP51          | R4300                 | 140             | -              |
| ▶                   | B-461    | <b>FNAHSL</b>      | 66.68              | 15.24               | -                  | -               | 25.40                        | 15.24                         | B33-153-461*        | i3300                 | B30 Monocolour        | 1500            | 1              |
| ▶                   | B-461    | <b>FNAHSL</b>      | 66.68              | 15.24               | -                  | -               | 25.40                        | 15.24                         | M-86-461            | BMP41, BMP51          | R4300                 | 120             | -              |
| <b>1.2 ml</b>       |          |                    |                    |                     |                    |                 |                              |                               |                     |                       |                       |                 |                |
| ▲                   | B-492    | <b>FNHL</b>        | 20.96              | 9.53                | -                  | -               | -                            | -                             | M6-130-492          | M610, M611            | R4300, R6400          | 500             | 1              |
| ▲                   | B-492    | <b>FNHL</b>        | 22.86              | 25.40               | -                  | -               | -                            | -                             | M6-156-492          | M610, M611            | R4300, R6400          | 250             | 1              |
| ▲                   | B-492    | <b>FNHL</b>        | 25.40              | 12.70               | -                  | -               | -                            | -                             | M6-17-492           | M610, M611            | R4300, R6400          | 250             | 1              |
| ▲                   | B-492    | <b>FNHL</b>        | 25.40              | 25.40               | -                  | -               | -                            | -                             | M6-19-492           | M610, M611            | R4300, R6400          | 250             | 1              |
| ▲                   | B-492    | <b>FNHL</b>        | 25.40              | 44.45               | -                  | -               | -                            | -                             | M6-203-492          | M610, M611            | R4300, R6400          | 250             | 1              |
| ▲                   | B-492    | <b>FNHL</b>        | 25.40              | 48.26               | -                  | -               | -                            | -                             | M6-204-492          | M610, M611            | R4300, R6400          | 250             | 1              |
| <b>1.5 ml</b>       |          |                    |                    |                     |                    |                 |                              |                               |                     |                       |                       |                 |                |
| ⊙                   | B-499    | <b>FNA</b>         | 12.70              | -                   | 4.88               | -               | -                            | -                             | M21-500-499         | M210-LAB, M211        | R4300                 | 1               | -              |
| ⊙                   | B-499    | <b>FNA</b>         | 12.70              | -                   | 4.88               | -               | -                            | -                             | MC-500-499          | BMP41, BMP51          | R4300                 | 1               | -              |
| ⊙                   | B-461    | <b>FNAHSL</b>      | 12.70              | -                   | 6.40               | -               | -                            | -                             | M21-500-461-AW**    | M210-LAB, M211        | R4300                 | 1               | -              |
| ⊙                   | B-461    | <b>FNAHSL</b>      | 12.70              | -                   | 7.62               | -               | -                            | -                             | MC-500-461-AW**     | BMP51                 | R4300                 | 1               | -              |
| ⊙                   | B-492    | <b>FNHL</b>        | 12.70              | -                   | 7.62               | -               | -                            | -                             | MC-500-492          | BMP41, BMP51          | R6400                 | 1               | -              |
| ⊙                   | B-499    | <b>FNA</b>         | 12.70              | -                   | 9.14               | -               | -                            | -                             | M7C-500-499         | M710                  | R4300, R6000HF, R6200 | 1               | 1              |

\*Label is rotated 90° on liner. \*\*AW = All White / no transparent area.

>>>

▶ These labels are also suitable for Eppendorf tubes and PCR process.



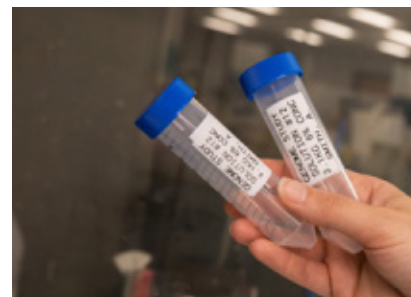
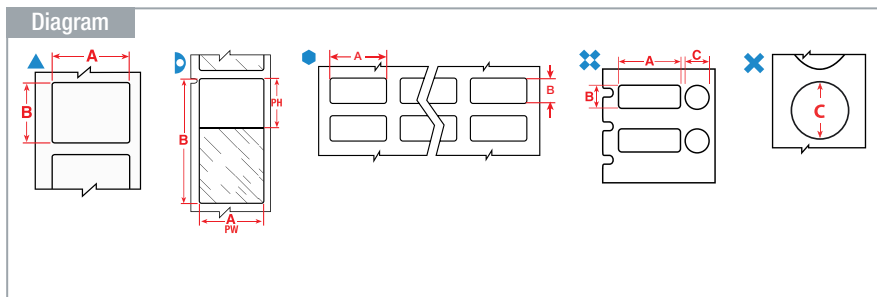

The background colours in the Order Reference column represent the material colour.

See page 58 for Brady's range of label printers.

Labels are shown per vial / tube size and in order of label width.

| Diagram             | Material | Special Properties | Label Width A (mm) | Label Height B (mm) | Label Length B (m) | Diameter C (mm) | Printable Area Width PW (mm) | Printable Area Height PH (mm) | Order Reference     | Printer Compatibility | Printer Ribbon Series | Labels per Roll | Labels per Row |
|---------------------|----------|--------------------|--------------------|---------------------|--------------------|-----------------|------------------------------|-------------------------------|---------------------|-----------------------|-----------------------|-----------------|----------------|
| <b>1.5 - 2.0 ml</b> |          |                    |                    |                     |                    |                 |                              |                               |                     |                       |                       |                 |                |
| ▲                   | B-490    | <b>F N H L</b>     | 12.70              | 41.91               | -                  | -               | -                            | -                             | M-124-490           | BMP41, BMP51          | R4300                 | 180             | -              |
| ▲                   | B-492    | <b>F N H L</b>     | 12.70              | 41.91               | -                  | -               | -                            | -                             | M-124-492           | BMP51                 | R6400                 | 180             | -              |
| ▲                   | B-492    | <b>F H L</b>       | 22.86              | 12.70               | -                  | 11.18           | -                            | -                             | M-117-492           | BMP51                 | R6400                 | 240             | -              |
| ▲                   | B-499    | <b>F A</b>         | 22.86              | 12.70               | -                  | 11.18           | -                            | -                             | M-117-499           | BMP51                 | R4300                 | 240             | -              |
| ▲                   | B-492    | <b>F H L</b>       | 25.40              | 12.70               | -                  | 9.53            | -                            | -                             | M-120-492           | BMP51                 | R6400                 | 240             | -              |
| ▲                   | B-499    | <b>F A</b>         | 25.40              | 12.70               | -                  | 9.53            | -                            | -                             | M-120-499           | BMP51                 | R4300                 | 240             | -              |
| ▲                   | B-494    | <b>F N H</b>       | 25.40              | 12.70               | -                  | -               | -                            | -                             | B33-310-494-BL      | i3300, i5300          | R6400                 | 2500            | 1              |
| ▲                   | B-494    | <b>F N H</b>       | 25.40              | 12.70               | -                  | -               | -                            | -                             | B33-310-494-GN      | i3300, i5300          | R6400                 | 2500            | 1              |
| ▲                   | B-494    | <b>F N H</b>       | 25.40              | 12.70               | -                  | -               | -                            | -                             | B33-310-494-OR      | i3300, i5300          | R6400                 | 2500            | 1              |
| ▲                   | B-494    | <b>F N H</b>       | 25.40              | 12.70               | -                  | -               | -                            | -                             | B33-310-494-PK      | i3300, i5300          | R6400                 | 2500            | 1              |
| ▲                   | B-494    | <b>F N H</b>       | 25.40              | 12.70               | -                  | -               | -                            | -                             | B33-310-494-RD      | i3300, i5300          | R6400                 | 2500            | 1              |
| ▲                   | B-494    | <b>F N H</b>       | 25.40              | 12.70               | -                  | -               | -                            | -                             | B33-310-494-YL      | i3300, i5300          | R6400                 | 2500            | 1              |
| ▲                   | B-492    | <b>F N H L</b>     | 25.40              | 12.70               | -                  | -               | -                            | -                             | B33-59-492          | i3300                 | B30 Monocolour        | 2500            | 1              |
| ▲                   | B-494    | <b>F N H</b>       | 25.40              | 12.70               | -                  | -               | -                            | -                             | BPT-310-494-2.5-BL  | BBP12                 | R6400                 | 2500            | 1              |
| ▲                   | B-494    | <b>F N H</b>       | 25.40              | 12.70               | -                  | -               | -                            | -                             | BPT-310-494-2.5-GN  | BBP12                 | R6400                 | 2500            | 1              |
| ▲                   | B-494    | <b>F N H</b>       | 25.40              | 12.70               | -                  | -               | -                            | -                             | BPT-310-494-2.5-OR  | BBP12                 | R6400                 | 2500            | 1              |
| ▲                   | B-494    | <b>F N H</b>       | 25.40              | 12.70               | -                  | -               | -                            | -                             | BPT-310-494-2.5-PK  | BBP12                 | R6400                 | 2500            | 1              |
| ▲                   | B-494    | <b>F N H</b>       | 25.40              | 12.70               | -                  | -               | -                            | -                             | BPT-310-494-2.5-RD  | BBP12                 | R6400                 | 2500            | 1              |
| ▲                   | B-494    | <b>F N H</b>       | 25.40              | 12.70               | -                  | -               | -                            | -                             | BPT-310-494-2.5-YL  | BBP12                 | R6400                 | 2500            | 1              |
| ▲                   | B-494    | <b>F N H</b>       | 25.40              | 12.70               | -                  | -               | -                            | -                             | THT-310-494-10-BL   | i5100, i7100          | R6400                 | 10000           | 1              |
| ▲                   | B-494    | <b>F N H</b>       | 25.40              | 12.70               | -                  | -               | -                            | -                             | THT-310-494-10-GN   | i5100, i7100          | R6400                 | 10000           | 1              |
| ▲                   | B-494    | <b>F N H</b>       | 25.40              | 12.70               | -                  | -               | -                            | -                             | THT-310-494-10-OR   | i5100, i7100          | R6400                 | 10000           | 1              |
| ▲                   | B-494    | <b>F N H</b>       | 25.40              | 12.70               | -                  | -               | -                            | -                             | THT-310-494-10-PK   | i5100, i7100          | R6400                 | 10000           | 1              |
| ▲                   | B-494    | <b>F N H</b>       | 25.40              | 12.70               | -                  | -               | -                            | -                             | THT-310-494-10-RD   | i5100, i7100          | R6400                 | 10000           | 1              |
| ▲                   | B-494    | <b>F N H</b>       | 25.40              | 12.70               | -                  | -               | -                            | -                             | THT-310-494-10-YL   | i5100, i7100          | R6400                 | 10000           | 1              |
| ▲                   | B-7600   | <b>F N H L</b>     | 25.40              | 12.70               | -                  | -               | -                            | -                             | THT-310-7600-10     | BBP12, i7100, i5100   | R6000HF               | 10000           | 1              |
| ▲                   | B-7600   | <b>F N H L</b>     | 25.40              | 12.70               | -                  | -               | -                            | -                             | THT-310-7600-2.5SC  | BBP12                 | R6000HF               | 2500            | 1              |
| ▲                   | B-492    | <b>F N H L</b>     | 25.40              | 12.70               | -                  | -               | -                            | -                             | THT-59-492-10       | BBP12, i7100, i5100   | R6400                 | 10000           | 1              |
| ▲                   | B-492    | <b>F N H L</b>     | 25.40              | 12.70               | -                  | -               | -                            | -                             | THT-59-492-2.5-SC   | BBP12                 | R6400                 | 2500            | 1              |
| Ⓛ                   | B-461    | <b>F N A H S L</b> | 41.28              | 15.24               | -                  | -               | 15.24                        | 15.24                         | THT-133-461-1.5-SC* | BBP12                 | R7950                 | 1500            | 1              |
| Ⓛ                   | B-461    | <b>F N A H S L</b> | 41.29              | 15.24               | -                  | -               | 25.40                        | 15.24                         | THT-133-461-3*      | BBP12, i7100, i5100   | R4300, R7950          | 3000            | 1              |
| Ⓛ                   | B-461    | <b>F N A H S L</b> | 41.91              | 12.70               | -                  | -               | 19.05                        | 12.70                         | M-124-461           | BMP41, BMP51          | R4300                 | 180             | -              |
| Ⓛ                   | B-461    | <b>F N A H S L</b> | 66.68              | 15.24               | -                  | -               | 25.40                        | 15.24                         | THT-153-461*-1.5-SC | BBP12                 | R7950                 | 1500            | 1              |
| Ⓛ                   | B-461    | <b>F N A H S L</b> | 66.68              | 15.24               | -                  | -               | 25.40                        | 15.24                         | THT-153-461*-3      | BBP12, i7100, i5100   | R4300, R7950          | 3000            | 1              |
| ✕                   | B-492    | <b>F H L</b>       | -                  | -                   | -                  | 12.70           | -                            | -                             | M-83-492            | BMP41, BMP51          | R6400                 | 240             | -              |
| ✕                   | B-499    | <b>F A</b>         | -                  | -                   | -                  | 12.70           | -                            | -                             | M-83-499-OR-BK      | BMP41, BMP51          | R4300                 | 240             | -              |
| ✕                   | B-499    | <b>F A</b>         | -                  | -                   | -                  | 12.70           | -                            | -                             | M-83-499-RD-BK      | BMP41, BMP51          | R4300                 | 240             | -              |
| <b>1.5 - 8.0 ml</b> |          |                    |                    |                     |                    |                 |                              |                               |                     |                       |                       |                 |                |
| ⬢                   | B-492    | <b>F N H L</b>     | 25.40              | 9.53                | -                  | -               | -                            | -                             | B33-152-492         | i3300                 | B30 Monocolour        | 2500            | 2              |

\*Label is rotated 90° on liner.

>>

▶ These labels are also suitable for Eppendorf tubes and PCR process.

**F** Freezer environment **N** Liquid nitrogen environment **A** Autoclave environment **H** Hot water bath (100°C) **S** Self-laminating label **L** Low-profile (extremely thin) label **R** Removable

# Centrifuge / Microcentrifuge Labels

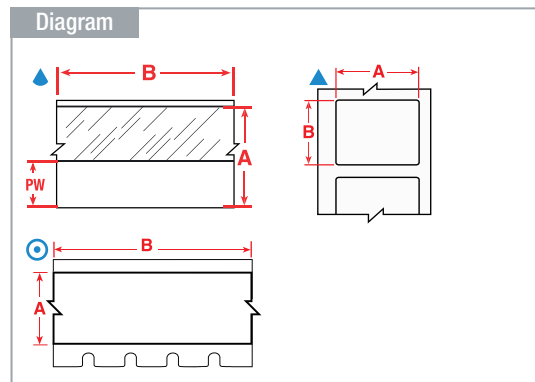

Labels are shown per vial / tube size and in order of label width.

The background colours in the Order Reference column represent the material colour.

See page 58 for Brady's range of label printers.

| Diagram              | Material | Special Properties | Label Width A (mm) | Label Height B (mm) | Label Length B (mm) | Diameter C (mm) | Printable Area Width PW (mm) | Printable Area Height PH (mm) | Order Reference    | Printer Compatibility | Printer Ribbon Series | Labels per Roll | Labels per Row |
|----------------------|----------|--------------------|--------------------|---------------------|---------------------|-----------------|------------------------------|-------------------------------|--------------------|-----------------------|-----------------------|-----------------|----------------|
| <b>2.0 - 8.0 ml</b>  |          |                    |                    |                     |                     |                 |                              |                               |                    |                       |                       |                 |                |
| ▲                    | B-494    | <b>F N H</b>       | 25.40              | 12.70               | -                   | -               | 25.40                        | 9.53                          | M6-17-494-BL       | M611, M610            | R6400                 | 500             | 1              |
| ▲                    | B-494    | <b>F N H</b>       | 25.40              | 12.70               | -                   | -               | 25.40                        | 9.53                          | M6-17-494-GN       | M611, M610            | R6400                 | 500             | 1              |
| ▲                    | B-494    | <b>F N H</b>       | 25.40              | 12.70               | -                   | -               | 25.40                        | 9.53                          | M6-17-494-OR       | M611, M610            | R6400                 | 500             | 1              |
| ▲                    | B-494    | <b>F N H</b>       | 25.40              | 12.70               | -                   | -               | 25.40                        | 9.53                          | M6-17-494-PK       | M611, M610            | R6400                 | 500             | 1              |
| ▲                    | B-494    | <b>F N H</b>       | 25.40              | 12.70               | -                   | -               | 25.40                        | 9.53                          | M6-17-494-RD       | M611, M610            | R6400                 | 500             | 1              |
| ▲                    | B-494    | <b>F N H</b>       | 25.40              | 12.70               | -                   | -               | 25.40                        | 9.53                          | M6-17-494-YL       | M611, M610            | R6400                 | 500             | 1              |
| ▲                    | B-494    | <b>F N H</b>       | 25.40              | 25.40               | -                   | -               | 25.40                        | 22.23                         | M6-19-494-BL       | M611, M610            | R6400                 | 250             | 1              |
| ▲                    | B-494    | <b>F N H</b>       | 25.40              | 25.40               | -                   | -               | 25.40                        | 22.23                         | M6-19-494-GN       | M611, M610            | R6400                 | 250             | 1              |
| ▲                    | B-494    | <b>F N H</b>       | 25.40              | 25.40               | -                   | -               | 25.40                        | 22.23                         | M6-19-494-OR       | M611, M610            | R6400                 | 250             | 1              |
| ▲                    | B-494    | <b>F N H</b>       | 25.40              | 25.40               | -                   | -               | 25.40                        | 22.23                         | M6-19-494-PK       | M611, M610            | R6400                 | 250             | 1              |
| ▲                    | B-494    | <b>F N H</b>       | 25.40              | 25.40               | -                   | -               | 25.40                        | 22.23                         | M6-19-494-RD       | M611, M610            | R6400                 | 250             | 1              |
| ▲                    | B-494    | <b>F N H</b>       | 25.40              | 25.40               | -                   | -               | 25.40                        | 22.23                         | M6-19-494-YL       | M611, M610            | R6400                 | 250             | 1              |
| <b>2.0 - 50.0 ml</b> |          |                    |                    |                     |                     |                 |                              |                               |                    |                       |                       |                 |                |
| ▲                    | B-427    | <b>F N S</b>       | 19.05              | -                   | 4.30                | -               | 9.53                         | -                             | M21-750-427        | M210-LAB, M211        | R4300                 | 1               | -              |
| ○                    | B-499    | <b>F N A</b>       | 19.05              | -                   | 4.88                | -               | -                            | -                             | M21-750-499        | M210-LAB, M211        | R4300                 | 1               | -              |
| ○                    | B-499    | <b>F N A</b>       | 19.05              | -                   | 4.88                | -               | -                            | -                             | MC-750-499         | BMP41, BMP51          | R4300                 | 1               | -              |
| ○                    | B-461    | <b>F N A H S L</b> | 19.05              | -                   | 6.40                | -               | -                            | -                             | M21-750-461-AW**   | M210-LAB, M211        | R4300                 | 1               | -              |
| ▲                    | B-427    | <b>F N S</b>       | 19.05              | -                   | 7.62                | -               | 9.53                         | -                             | MC-750-427         | BMP41, BMP51          | R4300                 | 1               | -              |
| ○                    | B-499    | <b>F N A</b>       | 25.40              | -                   | 4.88                | -               | -                            | -                             | MC-1000-499        | BMP51                 | R4300                 | 1               | -              |
| ○                    | B-499    | <b>F N A</b>       | 25.40              | -                   | 9.14                | -               | -                            | -                             | M7C-1000-499       | M710                  | R4300, R6000HF, R6200 | 1               | 1              |
| <b>15.0 ml</b>       |          |                    |                    |                     |                     |                 |                              |                               |                    |                       |                       |                 |                |
| ▲                    | B-7425   | <b>F N A H</b>     | 38.10              | 25.40               | -                   | -               | -                            | -                             | M-31-7425          | BMP51                 | R4300                 | 250             | 1              |
| <b>5.0 - 50.0 ml</b> |          |                    |                    |                     |                     |                 |                              |                               |                    |                       |                       |                 |                |
| ○                    | B-499    | <b>F N A</b>       | 48.26              | -                   | 9.14                | -               | -                            | -                             | M7C-1900-499       | M710                  | R4300, R6000HF, R6200 | 1               | 1              |
| <b>50.0 ml</b>       |          |                    |                    |                     |                     |                 |                              |                               |                    |                       |                       |                 |                |
| ○                    | B-461    | <b>F N A H S L</b> | 9.53               | -                   | 15.24               | -               | -                            | -                             | M6C-375-461        | M610, M611            | R4300, R6200          | 1               | 1              |
| ○                    | B-461    | <b>F N A H S L</b> | 12.70              | -                   | 15.24               | -               | -                            | -                             | M6C-500-461        | M610, M611            | R4300, R6200          | 1               | 1              |
| ▲                    | B-7600   | <b>F N H L</b>     | 25.40              | 25.40               | -                   | -               | -                            | -                             | THT-305-7600-2.5SC | BBP12                 | R6000HF               | 2500            | 1              |
| ▲                    | B-7600   | <b>F N H L</b>     | 25.40              | 25.40               | -                   | -               | -                            | -                             | THT-305-7600-3     | BBP12, i7100, i5100   | R6000HF               | 3000            | 1              |

\*\*AW = All White / no transparent area.

▶ These labels are also suitable for Eppendorf tubes and PCR process.

**F** Freezer environment **N** Liquid nitrogen environment **A** Autoclave environment **H** Hot water bath (100°C) **S** Self-laminating label **L** Low-profile (extremely thin) label **R** Removable

## Cryo Tubes & Vials

Brady's offers a range of labels designed specifically to identify laboratory samples for cryo storage. These labels can be applied to room temperature or to already frozen samples, albeit with a small overlap. The label will remain legible and will stick to the sample container during processing, even when exposed to extreme heat or chemicals like DMSO, Xylene and Ethanol, ensuring secure sample identification in the most challenging laboratory conditions.

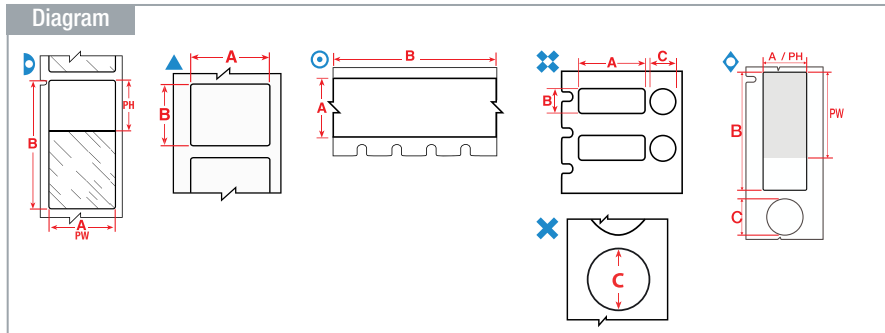

- F** Freezer environment
- N** Liquid nitrogen environment
- A** Autoclave environment
- H** Hot water bath (100°C)
- S** Self-laminating label
- L** Low-profile (extremely thin) label
- R** Removable

The background colours in the Order Reference column represent the material colour.

See page 58 for Brady's range of label printers.

Labels are shown per vial / tube size and in order of label width.

| Diagram             | Material | Special Properties | Label Width A (mm) | Label Height B (mm) | Label Length B (m) | Diameter C (mm) | Printable Area Width PW (mm) | Printable Area Height PH (mm) | Order Reference  | Printer Compatibility | Printer Ribbon Series | Labels per Roll | Labels per Row |
|---------------------|----------|--------------------|--------------------|---------------------|--------------------|-----------------|------------------------------|-------------------------------|------------------|-----------------------|-----------------------|-----------------|----------------|
| <b>0.5 - 0.7 ml</b> |          |                    |                    |                     |                    |                 |                              |                               |                  |                       |                       |                 |                |
| ▶                   | B-427    | <b>F N S</b>       | 12.70              | 19.05               | -                  | -               | 12.70                        | 9.53                          | M21-11-427       | M210-LAB, M211        | R4300, R4500          | 1               | 1              |
| ▲                   | B-499    | <b>F N A</b>       | 12.70              | 19.05               | -                  | -               | -                            | -                             | BM-11-499        | M610, M611, M710      | R4300, R6000HF        | 5000            | 1              |
| ▲                   | B-499    | <b>F N A</b>       | 12.70              | 19.05               | -                  | -               | -                            | -                             | M6-11-499        | M610, M611            | R4300, R6000HF, R6200 | 500             | 1              |
| ▲                   | B-499    | <b>F N A</b>       | 12.70              | 19.05               | -                  | -               | -                            | -                             | M7-11-499        | M710                  | R4300                 | 500             | 1              |
| ▲                   | B-499    | <b>F N A</b>       | 19.05              | 12.70               | -                  | -               | -                            | -                             | M-11-499         | BMP41, BMP51          | R4300                 | 220             | -              |
| ▲                   | B-499    | <b>F N A</b>       | 19.05              | 12.70               | -                  | -               | -                            | -                             | M21-11-499       | M210-LAB, M211        | R4300                 | 1               | 1              |
| ▶                   | B-461    | <b>F N A H S L</b> | 28.58              | 9.53                | -                  | -               | 19.05                        | 9.53                          | M-123-461*       | BMP51                 | R4300                 | 360             | -              |
| ▶                   | B-461    | <b>F N A H S L</b> | 28.58              | 12.70               | -                  | -               | 19.05                        | 12.70                         | M-122-461        | BMP51                 | R4300                 | 360             | -              |
| ▲                   | B-490    | <b>F N H L</b>     | 31.75              | 9.53                | -                  | -               | -                            | -                             | M-112-490        | BMP51                 | R4300                 | 360             | -              |
| ▶                   | B-461    | <b>F N A H S L</b> | 41.91              | 12.70               | -                  | -               | 19.05                        | 12.70                         | M6-202-461       | M610, M611            | R4300, R6200          | 500             | 1              |
| ▶                   | B-461    | <b>F N A H S L</b> | 44.45              | 12.70               | -                  | -               | 19.05                        | 12.70                         | M-72-461         | BMP41, BMP51          | R4300                 | 180             | -              |
| ▶                   | B-461    | <b>F N A H S L</b> | 45.72              | 15.24               | -                  | -               | 25.40                        | 15.24                         | M6-201-461       | M610, M611            | R4300, R6200          | 100             | 1              |
| <b>0.5 - 1.5 ml</b> |          |                    |                    |                     |                    |                 |                              |                               |                  |                       |                       |                 |                |
| ✕                   | B-492    | <b>F H L</b>       | -                  | -                   | -                  | 9.53            | -                            | -                             | M-82-492         | BMP41, BMP51          | R6400                 | 240             | -              |
| ✕                   | B-499    | <b>F A</b>         | -                  | -                   | -                  | 9.53            | -                            | -                             | M-82-499         | BMP41, BMP51          | R4300                 | 240             | -              |
| ✕                   | B-499    | <b>F A</b>         | -                  | -                   | -                  | 9.53            | -                            | -                             | M-82-499-OR-BK   | BMP41, BMP51          | R4300                 | 240             | -              |
| ✕                   | B-499    | <b>F A</b>         | -                  | -                   | -                  | 9.53            | -                            | -                             | M-82-499-RD-BK   | BMP41, BMP51          | R4300                 | 240             | -              |
| ✕                   | B-499    | <b>F A</b>         | -                  | -                   | -                  | 9.53            | -                            | -                             | M-82-499-YL-BK   | BMP41, BMP51          | R4300                 | 240             | -              |
| <b>0.5 - 2.0 ml</b> |          |                    |                    |                     |                    |                 |                              |                               |                  |                       |                       |                 |                |
| ▶                   | B-427    | <b>F N S</b>       | 12.70              | 55.88               | -                  | -               | 12.70                        | 19.05                         | M6-74-427        | M610, M611            | R4300                 | 100             | 1              |
| ▶                   | B-461    | <b>F N A H S L</b> | 55.88              | 12.70               | -                  | -               | 19.05                        | 12.70                         | M6-74-461        | M610, M611            | R4300                 | 100             | 1              |
| ▶                   | B-461    | <b>F N A H S L</b> | 63.50              | 38.10               | -                  | -               | 19.05                        | 38.10                         | M6-157-461       | M610, M611            | R4300                 | 100             | 1              |
| <b>0.6 ml</b>       |          |                    |                    |                     |                    |                 |                              |                               |                  |                       |                       |                 |                |
| ▲                   | B-492    | <b>F N H L</b>     | 9.53               | 20.96               | -                  | -               | -                            | -                             | M-130-492        | BMP41, BMP51          | R6400                 | 220             | -              |
| ▲                   | B-499    | <b>F N A</b>       | 9.53               | 20.96               | -                  | -               | -                            | -                             | M-130-499        | BMP41, BMP51          | R4300                 | 220             | -              |
| ⊙                   | B-499    | <b>F N A</b>       | 9.53               | -                   | 4.88               | -               | -                            | -                             | M21-375-499      | M210-LAB, M211        | R4300                 | 1               | -              |
| ⊙                   | B-499    | <b>F N A</b>       | 9.53               | -                   | 4.88               | -               | -                            | -                             | MC-375-499       | BMP41, BMP51          | R4300                 | 1               | -              |
| ⊙                   | B-461    | <b>F N A H S L</b> | 9.53               | -                   | 6.40               | -               | -                            | -                             | M21-375-461-AW** | M210-LAB, M211        | R4300                 | 1               | -              |
| ⊙                   | B-461    | <b>F N A H S L</b> | 9.53               | -                   | 7.62               | -               | -                            | -                             | MC-375-461-AW**  | BMP51                 | R4300                 | 1               | -              |
| ▲                   | B-499    | <b>F N A</b>       | 22.86              | 12.70               | -                  | -               | -                            | -                             | M-84-499         | BMP51                 | R4300                 | 200             | -              |
| <b>0.6 - 1.5 ml</b> |          |                    |                    |                     |                    |                 |                              |                               |                  |                       |                       |                 |                |
| ✕                   | B-499    | <b>F A</b>         | 25.40              | 9.53                | -                  | 9.53            | -                            | -                             | M6-98-499        | M610, M611            | R4300, R6000HF, R6200 | 500             | 1              |

\*\*AW = All White / no transparent area.

>>

# Cryo Tubes & Vials

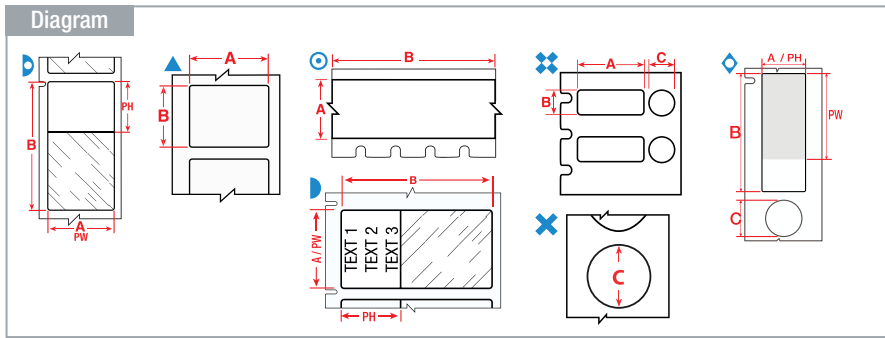

The background colours in the Order Reference column represent the material colour.

See page 58 for Brady's range of label printers.

Labels are shown per vial / tube size and in order of label width.

| Diagram              | Material | Special Properties | Label Width A (mm) | Label Height B (mm) | Label Length B (m) | Diameter C (mm) | Printable Area Width PW (mm) | Printable Area Height PH (mm) | Order Reference  | Printer Compatibility | Printer Ribbon Series | Labels per Roll | Labels per Row |
|----------------------|----------|--------------------|--------------------|---------------------|--------------------|-----------------|------------------------------|-------------------------------|------------------|-----------------------|-----------------------|-----------------|----------------|
| <b>1.0 - 8.0 ml</b>  |          |                    |                    |                     |                    |                 |                              |                               |                  |                       |                       |                 |                |
| ▲                    | B-492    | <b>F N H L</b>     | 12.70              | 25.40               | -                  | -               | -                            | -                             | M-131-492        | BMP41, BMP51          | R6400                 | 180             | -              |
| ▲                    | B-499    | <b>F N A</b>       | 12.70              | 25.40               | -                  | -               | -                            | -                             | M-131-499        | BMP41, BMP51          | R4300                 | 180             | -              |
| ▷                    | B-461    | <b>F N A H S L</b> | 15.24              | 66.68               | -                  | -               | 25.40                        | 15.24                         | M6-86-461        | M610, M611            | R4300                 | 100             | 1              |
| ⬢                    | B-499    | <b>F N A</b>       | 19.05              | 23.80               | -                  | -               | -                            | -                             | B33-91-499       | i3300, i5300          | B30 Monocolour        | 2500            | 4              |
| ⊗                    | B-499    | <b>F A</b>         | 22.86              | 12.70               | -                  | 12.70           | -                            | -                             | M6-117-499       | M610, M611            | R4300                 | 500             | 1              |
| ◇                    | B-494    | <b>F N H</b>       | 25.40              | 9.53                | -                  | 9.53            | 25.40                        | 6.35                          | M6-98-494-BL     | M611, M610            | R6400                 | 500             | 1              |
| ◇                    | B-494    | <b>F N H</b>       | 25.40              | 9.53                | -                  | 9.53            | 25.40                        | 6.35                          | M6-98-494-GN     | M611, M610            | R6400                 | 500             | 1              |
| ◇                    | B-494    | <b>F N H</b>       | 25.40              | 9.53                | -                  | 9.53            | 25.40                        | 6.35                          | M6-98-494-OR     | M611, M610            | R6400                 | 500             | 1              |
| ◇                    | B-494    | <b>F N H</b>       | 25.40              | 9.53                | -                  | 9.53            | 25.40                        | 6.35                          | M6-98-494-PK     | M611, M610            | R6400                 | 500             | 1              |
| ◇                    | B-494    | <b>F N H</b>       | 25.40              | 9.53                | -                  | 9.53            | 25.40                        | 6.35                          | M6-98-494-RD     | M611, M610            | R6400                 | 500             | 1              |
| ◇                    | B-494    | <b>F N H</b>       | 25.40              | 9.53                | -                  | 9.53            | 25.40                        | 6.35                          | M6-98-494-YL     | M611, M610            | R6400                 | 500             | 1              |
| ▷                    | B-427    | <b>F N S</b>       | 25.40              | 19.05               | -                  | -               | 25.40                        | 9.53                          | M21-18-427       | M210-LAB, M211        | R4300, R4500          | 1               | 1              |
| ▲                    | B-499    | <b>F N A</b>       | 25.40              | 19.05               | -                  | -               | -                            | -                             | M21-18-499       | M210-LAB, M211        | R4300                 | 1               | 1              |
| ▷                    | B-427    | <b>F N S</b>       | 25.40              | 66.68               | -                  | -               | 25.40                        | 25.40                         | M6-75-427        | M610, M611            | R4300                 | 100             | 1              |
| ▷                    | B-461    | <b>F N A H S L</b> | 28.58              | 9.53                | -                  | -               | 19.05                        | 9.53                          | M6-123-461*      | M610, M611            | R4300, R6200          | 500             | 1              |
| ▷                    | B-461    | <b>F N A H S L</b> | 28.58              | 12.70               | -                  | -               | 19.05                        | 12.70                         | M6-122-461*      | M610, M611            | R4300, R6200          | 500             | 1              |
| ▷                    | B-461    | <b>F N A H S L</b> | 41.28              | 15.24               | -                  | -               | 25.40                        | 15.24                         | M6-76-461        | M610, M611            | R4300                 | 250             | 1              |
| ▲                    | B-490    | <b>F N H L</b>     | 41.28              | 15.24               | -                  | -               | -                            | -                             | M6-76-490        | M610, M611            | R4300                 | 250             | 1              |
| ▷                    | B-461    | <b>F N A H S L</b> | 44.45              | 25.40               | -                  | -               | 25.40                        | 25.40                         | M-125-461        | BMP51                 | R4300                 | 180             | -              |
| ▷                    | B-461    | <b>F N A H S L</b> | 44.45              | 25.40               | -                  | -               | 25.40                        | 25.40                         | M6-203-461       | M610, M611            | R4300, R6200          | 100             | 1              |
| ▲                    | B-490    | <b>F N H L</b>     | 44.45              | 25.40               | -                  | -               | -                            | -                             | M-125-490        | BMP51                 | R4300                 | 180             | -              |
| ▷                    | B-461    | <b>F N A H S L</b> | 45.72              | 15.24               | -                  | -               | 25.40                        | 15.24                         | M-126-461        | BMP41, BMP51          | R4300                 | 180             | -              |
| ▲                    | B-490    | <b>F N H L</b>     | 45.72              | 15.24               | -                  | -               | -                            | -                             | M-126-490        | BMP41, BMP51          | R4300                 | 180             | -              |
| ▲                    | B-490    | <b>F N H L</b>     | 48.26              | 25.40               | -                  | -               | -                            | -                             | M6-78-490        | M610, M611            | R4300                 | 250             | 1              |
| ▷                    | B-461    | <b>F N A H S L</b> | 55.88              | 12.70               | -                  | -               | 19.05                        | 12.70                         | M-74-461         | M610, BMP51           | R4300                 | 140             | -              |
| ▷                    | B-461    | <b>F N A H S L</b> | 66.68              | 15.24               | -                  | -               | 25.40                        | 15.24                         | M-86-461         | BMP41, BMP51          | R4300                 | 120             | -              |
| ▷                    | B-461    | <b>F N A H S L</b> | 66.68              | 25.40               | -                  | -               | 25.40                        | 25.40                         | BM-75-461        | M610, M611, M710      | R6200                 | 1000            | 1              |
| ▷                    | B-461    | <b>F N A H S L</b> | 66.68              | 25.40               | -                  | -               | 25.40                        | 25.40                         | M6-75-461        | M610, M611            | R4300                 | 100             | 1              |
| ▷                    | B-461    | <b>F N A H S L</b> | 66.68              | 25.40               | -                  | -               | 25.40                        | 25.40                         | M6-75-461-YL     | M610, M611            | R4300                 | 100             | 1              |
| ▷                    | B-461    | <b>F N A H S L</b> | 66.68              | 25.40               | -                  | -               | 25.40                        | 25.40                         | M-75-461         | BMP51                 | R4300                 | 120             | -              |
| <b>1.0 - 15.0 ml</b> |          |                    |                    |                     |                    |                 |                              |                               |                  |                       |                       |                 |                |
| ▲                    | B-492    | <b>F N H L</b>     | 22.86              | 25.40               | -                  | -               | -                            | -                             | M-156-492        | BMP51                 | R6400                 | 180             | -              |
| <b>1.5 ml</b>        |          |                    |                    |                     |                    |                 |                              |                               |                  |                       |                       |                 |                |
| ⊙                    | B-499    | <b>F N A</b>       | 12.70              | -                   | 4.88               | -               | -                            | -                             | M21-500-499      | M210-LAB, M211        | R4300                 | 1               | -              |
| ⊙                    | B-499    | <b>F N A</b>       | 12.70              | -                   | 4.88               | -               | -                            | -                             | MC-500-499       | BMP41, BMP51          | R4300                 | 1               | -              |
| ⊙                    | B-461    | <b>F N A H S L</b> | 12.70              | -                   | 6.40               | -               | -                            | -                             | M21-500-461-AW** | M210-LAB, M211        | R4300                 | 1               | -              |
| ⊙                    | B-461    | <b>F N A H S L</b> | 12.70              | -                   | 7.62               | -               | -                            | -                             | MC-500-461-AW**  | BMP51                 | R4300                 | 1               | -              |
| ⊙                    | B-499    | <b>F N A</b>       | 12.70              | -                   | 9.14               | -               | -                            | -                             | M7C-500-499      | M710                  | R4300, R6000HF, R6200 | 1               | 1              |
| <b>1.5 - 2.0 ml</b>  |          |                    |                    |                     |                    |                 |                              |                               |                  |                       |                       |                 |                |
| ⊗                    | B-499    | <b>F A</b>         | -                  | -                   | -                  | 12.70           | -                            | -                             | M-83-499         | BMP41, BMP51          | R4300                 | 240             | -              |
| ⊗                    | B-499    | <b>F A</b>         | -                  | -                   | -                  | 12.70           | -                            | -                             | M-83-499-OR-BK   | BMP41, BMP51          | R4300                 | 240             | -              |
| ⊗                    | B-499    | <b>F A</b>         | -                  | -                   | -                  | 12.70           | -                            | -                             | M-83-499-RD-BK   | BMP41, BMP51          | R4300                 | 240             | -              |
| ⊗                    | B-499    | <b>F A</b>         | -                  | -                   | -                  | 12.70           | -                            | -                             | M-83-499-YL-BK   | BMP41, BMP51          | R4300                 | 240             | -              |

\*\*AW = All White / no transparent area.

>>>

**F** Freezer environment **N** Liquid nitrogen environment **A** Autoclave environment **H** Hot water bath (100°C) **S** Self-laminating label **L** Low-profile (extremely thin) label **R** Removable

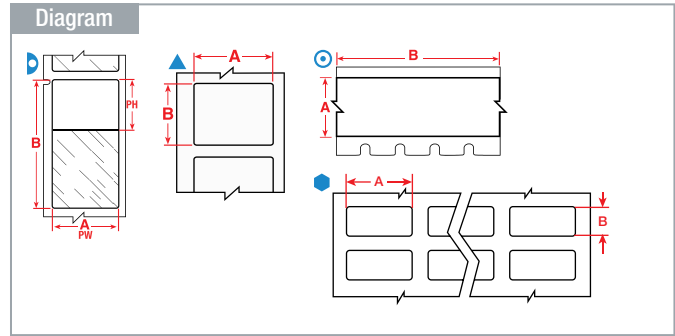
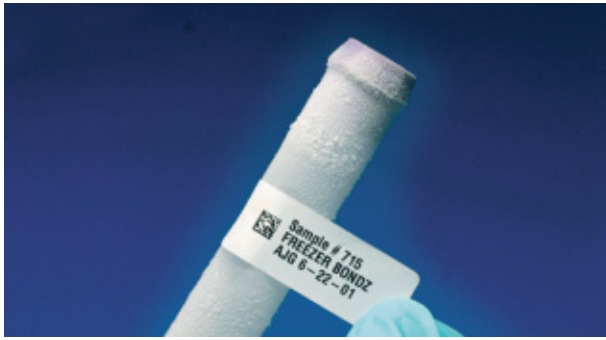

The background colours in the Order Reference column represent the material colour.

See page 58 for Brady's range of label printers.

Labels are shown per vial / tube size and in order of label width.

| Diagram               | Material | Special Properties | Label Width A (mm) | Label Height B (mm) | Label Length B (m) | Diameter C (mm) | Printable Area Width PW (mm) | Printable Area Height PH (mm) | Order Reference  | Printer Compatibility | Printer Ribbon Series | Labels per Roll | Labels per Row |
|-----------------------|----------|--------------------|--------------------|---------------------|--------------------|-----------------|------------------------------|-------------------------------|------------------|-----------------------|-----------------------|-----------------|----------------|
| <b>2.0 - 8.0 ml</b>   |          |                    |                    |                     |                    |                 |                              |                               |                  |                       |                       |                 |                |
| ▲                     | B-494    | <b>F N H</b>       | 25.40              | 12.70               | -                  | -               | 25.40                        | 9.53                          | M6-17-494-BL     | M611, M610            | R6400                 | 500             | 1              |
| ▲                     | B-494    | <b>F N H</b>       | 25.40              | 12.70               | -                  | -               | 25.40                        | 9.53                          | M6-17-494-GN     | M611, M610            | R6400                 | 500             | 1              |
| ▲                     | B-494    | <b>F N H</b>       | 25.40              | 12.70               | -                  | -               | 25.40                        | 9.53                          | M6-17-494-OR     | M611, M610            | R6400                 | 500             | 1              |
| ▲                     | B-494    | <b>F N H</b>       | 25.40              | 12.70               | -                  | -               | 25.40                        | 9.53                          | M6-17-494-PK     | M611, M610            | R6400                 | 500             | 1              |
| ▲                     | B-494    | <b>F N H</b>       | 25.40              | 12.70               | -                  | -               | 25.40                        | 9.53                          | M6-17-494-RD     | M611, M610            | R6400                 | 500             | 1              |
| ▲                     | B-494    | <b>F N H</b>       | 25.40              | 12.70               | -                  | -               | 25.40                        | 9.53                          | M6-17-494-YL     | M611, M610            | R6400                 | 500             | 1              |
| ●                     | B-499    | <b>F N A</b>       | 25.40              | 19.05               | -                  | -               | -                            | -                             | B33-88-499       | i3300, i5300          | B30 Monocolour        | 2500            | 2              |
| ▲                     | B-494    | <b>F N H</b>       | 25.40              | 25.40               | -                  | -               | 25.40                        | 22.23                         | M6-19-494-BL     | M611, M610            | R6400                 | 250             | 1              |
| ▲                     | B-494    | <b>F N H</b>       | 25.40              | 25.40               | -                  | -               | 25.40                        | 22.23                         | M6-19-494-GN     | M611, M610            | R6400                 | 250             | 1              |
| ▲                     | B-494    | <b>F N H</b>       | 25.40              | 25.40               | -                  | -               | 25.40                        | 22.23                         | M6-19-494-OR     | M611, M610            | R6400                 | 250             | 1              |
| ▲                     | B-494    | <b>F N H</b>       | 25.40              | 25.40               | -                  | -               | 25.40                        | 22.23                         | M6-19-494-PK     | M611, M610            | R6400                 | 250             | 1              |
| ▲                     | B-494    | <b>F N H</b>       | 25.40              | 25.40               | -                  | -               | 25.40                        | 22.23                         | M6-19-494-RD     | M611, M610            | R6400                 | 250             | 1              |
| ▲                     | B-494    | <b>F N H</b>       | 25.40              | 25.40               | -                  | -               | 25.40                        | 22.23                         | M6-19-494-YL     | M611, M610            | R6400                 | 250             | 1              |
| <b>2.0 - 50.0 ml</b>  |          |                    |                    |                     |                    |                 |                              |                               |                  |                       |                       |                 |                |
| ○                     | B-499    | <b>F N A</b>       | 19.05              | -                   | 4.88               | -               | -                            | -                             | M21-750-499      | M210-LAB, M211        | R4300                 | 1               | -              |
| ○                     | B-499    | <b>F N A</b>       | 19.05              | -                   | 4.88               | -               | -                            | -                             | MC-750-499       | BMP41, BMP51          | R4300                 | 1               | -              |
| ○                     | B-461    | <b>F N A H S L</b> | 19.05              | -                   | 6.40               | -               | -                            | -                             | M21-750-461-AW** | M210-LAB, M211        | R4300                 | 1               | -              |
| ○                     | B-499    | <b>F N A</b>       | 25.40              | -                   | 4.88               | -               | -                            | -                             | MC-1000-499      | BMP51                 | R4300                 | 1               | -              |
| ○                     | B-461    | <b>F N A H S L</b> | 25.40              | -                   | 7.62               | -               | -                            | -                             | MC-1000-461-AW** | BMP51                 | R4300                 | 1               | -              |
| ○                     | B-499    | <b>F N A</b>       | 25.40              | -                   | 9.14               | -               | -                            | -                             | M7C-1000-499     | M710                  | R4300, R6000HF, R6200 | 1               | 1              |
| <b>4.0 - 50.0 ml</b>  |          |                    |                    |                     |                    |                 |                              |                               |                  |                       |                       |                 |                |
| ○                     | B-461    | <b>F N A H S L</b> | 31.75              | -                   | 7.62               | -               | -                            | -                             | MC-1250-461-AW** | BMP51                 | R4300                 | 1               | -              |
| <b>12.0 - 14.0 ml</b> |          |                    |                    |                     |                    |                 |                              |                               |                  |                       |                       |                 |                |
| ▷                     | B-461    | <b>F N A H S L</b> | 95.25              | 38.10               | -                  | -               | 31.75                        | 38.10                         | M-119-461        | BMP51                 | R4300                 | 80              | -              |
| <b>12.0 - 24.0 ml</b> |          |                    |                    |                     |                    |                 |                              |                               |                  |                       |                       |                 |                |
| ●                     | B-499    | <b>F N A</b>       | 12.70              | 36.50               | -                  | -               | -                            | -                             | B33-87-499       | i3300, i5300          | B30 Monocolour        | 2500            | 6              |
| ▲                     | B-498    | <b>F R</b>         | 12.70              | 38.10               | -                  | -               | -                            | -                             | BM-29-498        | M610, M611, M710      | R6200                 | 5000            | 1              |
| ▲                     | B-499    | <b>F N A</b>       | 12.70              | 38.10               | -                  | -               | -                            | -                             | M7-29-499        | M710                  | R6200                 | 500             | 1              |
| ▲                     | B-492    | <b>F N H L</b>     | 25.40              | 48.26               | -                  | -               | -                            | -                             | M-78-492         | BMP51                 | R6400                 | 100             | -              |
| ▲                     | B-498    | <b>F R</b>         | 38.10              | 12.70               | -                  | -               | -                            | -                             | M6-29-498        | M610, M611            | R6200                 | 500             | 1              |
| ▲                     | B-499    | <b>F N A</b>       | 38.10              | 31.75               | -                  | -               | -                            | -                             | M-132-499        | BMP51                 | R4300                 | 160             | -              |
| ▷                     | B-461    | <b>F N A H S L</b> | 88.90              | 38.10               | -                  | -               | 25.40                        | 15.24                         | M6-77-461        | M610, M611            | R4300                 | 100             | 1              |
| ▷                     | B-461    | <b>F N A H S L</b> | 95.25              | 19.05               | -                  | -               | 25.40                        | 25.40                         | M6-79-461        | M610, M611            | R4300                 | 100             | 1              |
| <b>50.0 ml</b>        |          |                    |                    |                     |                    |                 |                              |                               |                  |                       |                       |                 |                |
| ○                     | B-461    | <b>F N A H S L</b> | 9.53               | -                   | 15.24              | -               | -                            | -                             | M6C-375-461      | M610, M611            | R4300, R6200          | 1               | 1              |
| ○                     | B-461    | <b>F N A H S L</b> | 12.70              | -                   | 15.24              | -               | -                            | -                             | M6C-500-461      | M610, M611            | R4300, R6200          | 1               | 1              |
| ●                     | B-499    | <b>F N A</b>       | 25.40              | 12.70               | -                  | -               | -                            | -                             | B33-5-499        | i3300, i5300          | B30 Monocolour        | 5000            | 3              |

\*\*AW = All White / no transparent area.

# Conical / Large Tube Labels



## Conical / Large Tube Labels

Brady offers several sample identification labels which are perfect to identify conicals. They are easy to handle, have great flexibility and easily wrap around curved sample containers. Your sample identification label will remain attached and legible, even when the sample is stored in a freezer, in liquid nitrogen or heated in an autoclave.

- F** Freezer environment
- N** Liquid nitrogen environment
- A** Autoclave environment
- H** Hot water bath (100°C)
- S** Self-laminating label
- L** Low-profile (extremely thin) label
- R** Removable

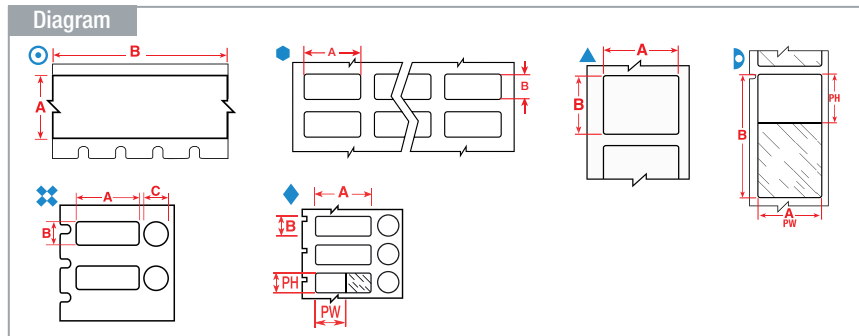

Labels are shown per vial / tube size and in order of label width.

The background colours in the Order Reference column represent the material colour.

See page 58 for Brady's range of label printers.

| Diagram             | Material | Special Properties | Label Width A (mm) | Label Height B (mm) | Label Length B (m) | Diameter C (mm) | Printable Area Width PW (mm) | Printable Area Height PH (mm) | Order Reference     | Printer Compatibility | Printer Ribbon Series        | Labels per Roll | Labels per Row |
|---------------------|----------|--------------------|--------------------|---------------------|--------------------|-----------------|------------------------------|-------------------------------|---------------------|-----------------------|------------------------------|-----------------|----------------|
| <b>0.5 ml</b>       |          |                    |                    |                     |                    |                 |                              |                               |                     |                       |                              |                 |                |
| ●                   | B-499    | <b>F N A</b>       | 6.35               | 36.50               | -                  | -               | -                            | -                             | B33-90-499          | i3300, i5300          | B30 Monocolour               | 2500            | 6              |
| ○                   | B-423    | <b>F A H</b>       | 6.35               | -                   | 6.40               | -               | -                            | -                             | M21-250-423         | M210-LAB, M211        | R6200                        | 1               | -              |
| ●                   | B-499    | <b>F N A</b>       | 19.05              | 6.35                | -                  | -               | -                            | -                             | B33-1-499           | i3300, i5300          | B30 Monocolour               | 10000           | 4              |
| ▷                   | B-427    | <b>F N S</b>       | 25.40              | 63.50               | -                  | -               | 25.40                        | 19.05                         | M6-21-427           | M611, M610, M710      | R4300, R6200, R4400          | 100             | 1              |
| <b>0.5 - 0.7 ml</b> |          |                    |                    |                     |                    |                 |                              |                               |                     |                       |                              |                 |                |
| ▷                   | B-427    | <b>F N S</b>       | 12.70              | 19.05               | -                  | -               | 12.70                        | 9.53                          | M21-11-427          | M210-LAB, M211        | R4300, R4500                 | 1               | 1              |
| ●                   | B-499    | <b>F N A</b>       | 12.70              | 19.05               | -                  | -               | -                            | -                             | B33-68-499          | i3300                 | B30 Monocolour               | 1500            | 4              |
| ▲                   | B-499    | <b>F N A</b>       | 12.70              | 19.05               | -                  | -               | -                            | -                             | M7-11-499           | M710                  | R4300                        | 500             | 1              |
| ●                   | B-499    | <b>F N A</b>       | 12.70              | 19.05               | -                  | -               | -                            | -                             | THT-68-499-10       | BBP12, i7100, i5100   | R4900                        | 10000           | 4              |
| ▲                   | B-499    | <b>F N A</b>       | 12.70              | 25.40               | -                  | -               | -                            | -                             | BPT-620-499         | BBP12                 | R7950                        | 1000            | 1              |
| ▲                   | B-499    | <b>F N A</b>       | 12.70              | 25.40               | -                  | -               | -                            | -                             | B33-620-499         | i3300                 | B30-R6000HF                  | 1000            | 1              |
| ▷                   | B-427    | <b>F N S</b>       | 12.70              | 55.88               | -                  | -               | 12.70                        | 19.05                         | THT-127-427-3*      | BBP12, i7100, i5100   | R4300, R7950                 | 3000            | 1              |
| ▲                   | B-499    | <b>F N A</b>       | 19.05              | 12.70               | -                  | -               | -                            | -                             | M21-11-499          | M210-LAB, M211        | R4300                        | 1               | 1              |
| ▲                   | B-423    | <b>F A H</b>       | 19.05              | 12.70               | -                  | -               | -                            | -                             | M21-7-423           | M210-LAB, M211        | R6000HF                      | 1               | 1              |
| ◆                   | B-461    | <b>F A H S L</b>   | 25.40              | 9.53                | -                  | 9.53            | 25.40                        | 9.53                          | BPT-606-461         | BBP12                 | R7950                        | 1000            | 1              |
| ◆                   | B-461    | <b>F A H S L</b>   | 25.40              | 9.53                | -                  | 9.53            | 25.40                        | 9.53                          | B33-606-461         | i3300                 | B30-R4300                    | 1000            | 1              |
| ⊗                   | B-499    | <b>F A</b>         | 25.40              | 9.53                | -                  | 9.53            | -                            | -                             | M7-98-499           | M710                  | R4300, R6000HF, R6200, R6900 | 500             | 1              |
| ●                   | B-499    | <b>F N A</b>       | 25.40              | 9.53                | -                  | -               | -                            | -                             | THT-152-499-1.5-SC  | BBP12                 | R7950, R4300, R4900          | 1500            | 2              |
| ●                   | B-499    | <b>F N A</b>       | 25.40              | 9.53                | -                  | -               | -                            | -                             | B33-152-499         | i3300                 | B30 Monocolour               | 1500            | 2              |
| ●                   | B-7600   | <b>F N H L</b>     | 25.40              | 9.53                | -                  | -               | -                            | -                             | THT-301-7600-2.5SC  | BBP12                 | R6000HF                      | 2500            | 2              |
| ●                   | B-7600   | <b>F N H L</b>     | 25.40              | 9.53                | -                  | -               | -                            | -                             | THT-301-7600-3      | BBP12, i7100, i5100   | R6000HF                      | 3000            | 2              |
| ▲                   | B-492    | <b>F N H L</b>     | 25.40              | 9.53                | -                  | -               | -                            | -                             | M7-16-492           | M710                  | R6400                        | 500             | 1              |
| ●                   | B-499    | <b>F N A</b>       | 25.40              | 9.53                | -                  | -               | -                            | -                             | THT-152-499-3       | BBP12, i7100, i5100   | R4900                        | 3000            | 2              |
| ●                   | B-492    | <b>F N H L</b>     | 25.40              | 9.53                | -                  | -               | -                            | -                             | THT-152-492-2.5-SC  | BBP12                 | R6400                        | 2500            | 2              |
| ●                   | B-492    | <b>F N H L</b>     | 25.40              | 9.53                | -                  | -               | -                            | -                             | THT-152-492-3       | BBP12, i7100, i5100   | R6400                        | 3000            | 2              |
| ●                   | B-425A   | <b>F</b>           | 25.40              | 10.00               | -                  | -               | -                            | -                             | THT-30-425-10       | BBP12, i7100, i5100   | R6400                        | 10000           | 3              |
| ▷                   | B-461    | <b>F N A H S L</b> | 55.88              | 12.70               | -                  | -               | 19.05                        | 12.70                         | THT-127-461-1.5-SC* | BBP12                 | R7950                        | 1500            | 1              |
| ▷                   | B-461    | <b>F N A H S L</b> | 55.88              | 12.70               | -                  | -               | 19.05                        | 12.70                         | THT-127-461-3*      | BBP12, i7100, i5100   | R4300, R7950                 | 3000            | 1              |
| ▷                   | B-461    | <b>F N A H S L</b> | 55.88              | 12.70               | -                  | -               | 55.88                        | 12.70                         | B33-127-461         | i3300                 | B30 Monocolour               | 1500            | 3              |
| <b>0.5 - 8.0 ml</b> |          |                    |                    |                     |                    |                 |                              |                               |                     |                       |                              |                 |                |
| ⊗                   | B-492    | <b>F H L</b>       | 25.40              | 9.53                | -                  | 9.53            | -                            | -                             | THT-249-492-1.5-SC  | BBP12                 | R6400                        | 1500            | 1              |
| ⊗                   | B-499    | <b>F A</b>         | 25.40              | 9.53                | -                  | 9.53            | -                            | -                             | THT-249-499-1.5-SC  | BBP12                 | R7950, R4300, R4900          | 1500            | 1              |
| ⊗                   | B-7600   | <b>F N H L</b>     | 25.40              | 9.53                | -                  | 9.53            | -                            | -                             | THT-307-7600-1.5SC  | BBP12                 | R6000HF                      | 1500            | 1              |
| ⊗                   | B-492    | <b>F H L</b>       | 25.40              | 12.70               | -                  | 9.53            | -                            | -                             | THT-250-492-1.5-SC  | BBP12                 | R6400                        | 1500            | 1              |
| ⊗                   | B-7600   | <b>F N H L</b>     | 25.40              | 12.70               | -                  | 9.53            | -                            | -                             | THT-308-7600-1.5SC  | BBP12                 | R6000HF                      | 1500            | 1              |
| ⊗                   | B-492    | <b>F H L</b>       | 25.40              | 12.70               | -                  | 11.18           | -                            | -                             | THT-251-492-1.5-SC  | BBP12                 | R6400                        | 1500            | 1              |
| ⊗                   | B-7600   | <b>F N H L</b>     | 25.40              | 12.70               | -                  | 11.18           | -                            | -                             | THT-309-7600-1.5SC  | BBP12                 | R6000HF                      | 1500            | 1              |

\*Label is rotated 90° on liner.

\*\*AW = All White / no transparent area.

>>>

# Conical / Large Tube Labels

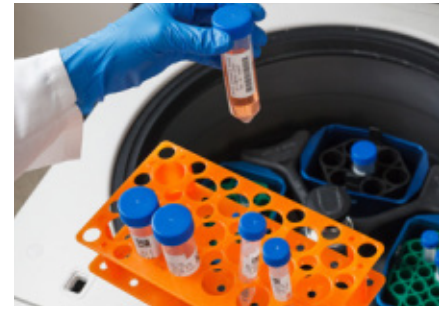
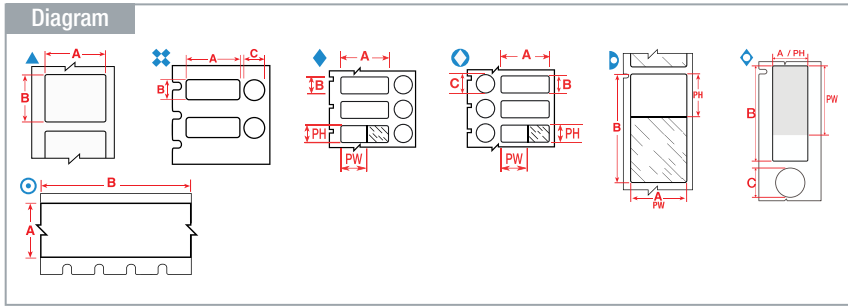

The background colours in the Order Reference column represent the material colour.

See page 58 for Brady's range of label printers.

Labels are shown per vial / tube size and in order of label width.

| Diagram             | Material | Special Properties | Label Width A (mm) | Label Height B (mm) | Label Length B (m) | Diameter C (mm) | Printable Area Width PW (mm) | Printable Area Height PH (mm) | Order Reference    | Printer Compatibility | Printer Ribbon Series        | Labels per Roll | Labels per Row |
|---------------------|----------|--------------------|--------------------|---------------------|--------------------|-----------------|------------------------------|-------------------------------|--------------------|-----------------------|------------------------------|-----------------|----------------|
| <b>0.5 - 8.0 ml</b> |          |                    |                    |                     |                    |                 |                              |                               |                    |                       |                              |                 |                |
| ▲                   | B-499    | <b>FNA</b>         | 25.40              | 12.70               | -                  | -               | -                            | -                             | M21-131-499        | M210-LAB, M211        | R4300                        | 1               | 1              |
| ▲                   | B-423    | <b>F AH</b>        | 25.40              | 12.70               | -                  | -               | -                            | -                             | M21-17-423         | M210-LAB, M211        | R6000HF                      | 1               | 1              |
| <b>0.6 ml</b>       |          |                    |                    |                     |                    |                 |                              |                               |                    |                       |                              |                 |                |
| ⊙                   | B-499    | <b>FNA</b>         | 9.53               | -                   | 4.88               | -               | -                            | -                             | M21-375-499        | M210-LAB, M211        | R4300                        | 1               | -              |
| ⊙                   | B-499    | <b>FNA</b>         | 9.53               | -                   | 4.88               | -               | -                            | -                             | MC-375-499         | BMP41, BMP51          | R4300                        | 1               | -              |
| ⊙                   | B-461    | <b>FNAHSL</b>      | 9.53               | -                   | 6.40               | -               | -                            | -                             | M21-375-461-AW**   | M210-LAB, M211        | R4300                        | 1               | -              |
| ▲                   | B-499    | <b>FNA</b>         | 22.86              | 12.70               | -                  | -               | -                            | -                             | THT-125-499-1.5-SC | BBP12                 | R7950, R4300, R4900          | 1500            | 1              |
| ▲                   | B-499    | <b>FNA</b>         | 22.86              | 12.70               | -                  | -               | -                            | -                             | B33-125-499        | i3300                 | B30 Monocolour               | 1500            | 1              |
| ▲                   | B-499    | <b>FNA</b>         | 22.86              | 12.70               | -                  | -               | -                            | -                             | M7-84-499          | M710                  | R4300, R6000HF, R6200, R6900 | 500             | 1              |
| ▲                   | B-499    | <b>FNA</b>         | 22.86              | 12.70               | -                  | -               | -                            | -                             | THT-125-499-3      | BBP12, i7100, i5100   | R4900                        | 3000            | 1              |
| <b>1.0 - 2.0 ml</b> |          |                    |                    |                     |                    |                 |                              |                               |                    |                       |                              |                 |                |
| ▷                   | B-461    | <b>FNAHSL</b>      | 15.00              | 40.00               | -                  | -               | 15.00                        | 29.97                         | BPTLAB-21-461-2.5  | BBP12                 | R7950                        | 2500            | 1              |
| ▷                   | B-461    | <b>FNAHSL</b>      | 15.24              | 38.10               | -                  | -               | 15.24                        | 33.00                         | M7-100-461         | M710                  | R6200                        | 500             | 1              |
| ▷                   | B-461    | <b>FNAHSL</b>      | 15.24              | 38.10               | -                  | -               | 15.24                        | 33.02                         | BPT-628-461*       | BBP12                 | R7950                        | 2500            | 2              |
| ▷                   | B-461    | <b>FNAHSL</b>      | 15.24              | 38.10               | -                  | -               | 15.24                        | 33.02                         | B33-628-461*       | i3300                 | B30-R4300                    | 2500            | 2              |
| ▷                   | B-461    | <b>FNAHSL</b>      | 15.24              | 41.28               | -                  | 12.70           | 15.24                        | 30.00                         | M7-116-461         | M710                  | R6200                        | 150             | 1              |
| ▷                   | B-461    | <b>FNAHSL</b>      | 15.24              | 66.68               | -                  | -               | 15.24                        | 25.40                         | BPT-612-461        | BBP12                 | R7950                        | 1500            | 3              |
| ▷                   | B-461    | <b>FNAHSL</b>      | 15.24              | 66.68               | -                  | -               | 15.24                        | 25.40                         | B33-612-461        | i3300                 | B30-R4300                    | 1500            | 3              |
| ⊕                   | B-499    | <b>F A</b>         | 25.40              | 9.53                | -                  | 9.53            | -                            | -                             | THT-163-499-3      | i7100, i5100          | R4900                        | 3000            | 1              |
| ⊕                   | B-7600   | <b>FN H L</b>      | 25.40              | 9.53                | -                  | 9.53            | -                            | -                             | THT-304-7600-3     | BBP12, i7100, i5100   | R6000HF                      | 3000            | 1              |
| ◇                   | B-494    | <b>FN H</b>        | 25.40              | 9.53                | -                  | 9.53            | -                            | -                             | THT-304-494-3-YL   | i5100, i7100          | R6400                        | 3000            | 1              |
| ◇                   | B-494    | <b>FN H</b>        | 25.40              | 9.53                | -                  | 9.53            | -                            | -                             | THT-304-494-3-RD   | i5100, i7100          | R6400                        | 3000            | 1              |
| ◇                   | B-494    | <b>FN H</b>        | 25.40              | 9.53                | -                  | 9.53            | -                            | -                             | THT-304-494-3-PK   | i5100, i7100          | R6400                        | 3000            | 1              |
| ◇                   | B-494    | <b>FN H</b>        | 25.40              | 9.53                | -                  | 9.53            | -                            | -                             | THT-304-494-3-OR   | i5100, i7100          | R6400                        | 3000            | 1              |
| ◇                   | B-494    | <b>FN H</b>        | 25.40              | 9.53                | -                  | 9.53            | -                            | -                             | THT-304-494-3-GN   | i5100, i7100          | R6400                        | 3000            | 1              |
| ◇                   | B-494    | <b>FN H</b>        | 25.40              | 9.53                | -                  | 9.53            | -                            | -                             | THT-304-494-3-BL   | i5100, i7100          | R6400                        | 3000            | 1              |
| ⊕                   | B-492    | <b>F H L</b>       | 25.40              | 9.53                | -                  | 9.53            | -                            | -                             | THT-163-492-3      | BBP12, i7100, i5100   | R6400                        | 3000            | 1              |
| ⊕                   | B-492    | <b>F H L</b>       | 25.40              | 12.70               | -                  | 9.53            | -                            | -                             | M7-118-492         | M710                  | R6400                        | 500             | 1              |
| ⊕                   | B-492    | <b>F H L</b>       | 25.40              | 12.70               | -                  | 9.53            | -                            | -                             | THT-181-492-3      | i7100, i5100          | R6400                        | 3000            | 1              |
| ⊕                   | B-7600   | <b>FN H L</b>      | 25.40              | 12.70               | -                  | 11.18           | -                            | -                             | THT-306-7600-3     | BBP12, i7100, i5100   | R6000HF                      | 3000            | 1              |
| ◇                   | B-494    | <b>FN H</b>        | 25.40              | 12.70               | -                  | 11.18           | -                            | -                             | THT-306-494-3-YL   | i5100, i7100          | R6400                        | 3000            | 1              |
| ◇                   | B-494    | <b>FN H</b>        | 25.40              | 12.70               | -                  | 11.18           | -                            | -                             | THT-306-494-3-RD   | i5100, i7100          | R6400                        | 3000            | 1              |
| ◇                   | B-494    | <b>FN H</b>        | 25.40              | 12.70               | -                  | 11.18           | -                            | -                             | THT-306-494-3-PK   | i5100, i7100          | R6400                        | 3000            | 1              |
| ◇                   | B-494    | <b>FN H</b>        | 25.40              | 12.70               | -                  | 11.18           | -                            | -                             | THT-306-494-3-OR   | i5100, i7100          | R6400                        | 3000            | 1              |
| ◇                   | B-494    | <b>FN H</b>        | 25.40              | 12.70               | -                  | 11.18           | -                            | -                             | THT-306-494-3-GN   | i5100, i7100          | R6400                        | 3000            | 1              |
| ◇                   | B-494    | <b>FN H</b>        | 25.40              | 12.70               | -                  | 11.18           | -                            | -                             | THT-306-494-3-BL   | i5100, i7100          | R6400                        | 3000            | 1              |
| ⊕                   | B-492    | <b>F H L</b>       | 25.40              | 12.70               | -                  | 11.18           | -                            | -                             | THT-182-492-3      | BBP12, i7100, i5100   | R6400                        | 3000            | 1              |
| ◆                   | B-461    | <b>F AHSL</b>      | 40.00              | 15.00               | -                  | 9.00            | 40.00                        | 15.00                         | BPTLAB-20-461-2.5  | BBP12                 | R7950                        | 2500            | 1              |
| ◆                   | B-461    | <b>F AHSL</b>      | 40.00              | 15.00               | -                  | 9.53            | 29.97                        | 15.00                         | M7-101-461         | M710                  | R6200                        | 250             | 1              |
| ◆                   | B-461    | <b>F AHSL</b>      | 41.28              | 15.24               | -                  | 12.70           | 41.28                        | 15.24                         | BPT-608-461        | BBP12                 | R7950                        | 1000            | 1              |
| ◆                   | B-461    | <b>F AHSL</b>      | 41.28              | 15.24               | -                  | 12.70           | 41.28                        | 15.24                         | B33-608-461        | i3300                 | B30-R4300                    | 1000            | 1              |
| ⊕                   | B-499    | <b>F A</b>         | 41.28              | 15.24               | -                  | 12.70           | -                            | -                             | BPT-608-499        | BBP12                 | R7950                        | 1000            | 1              |

\*Label is rotated 90° on liner.

\*\*AW = All White / no transparent area.

>>

**F** Freezer environment **N** Liquid nitrogen environment **A** Autoclave environment **H** Hot water bath (100°C) **S** Self-laminating label **L** Low-profile (extremely thin) label **R** Removable

# Conical / Large Tube Labels

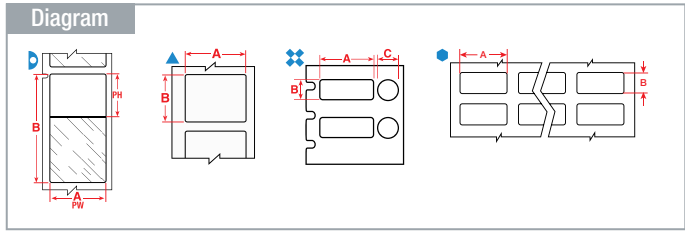
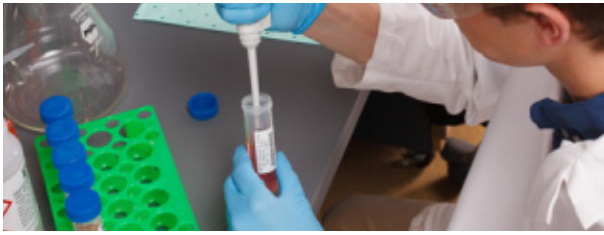

The background colours in the Order Reference column represent the material colour.

See page 58 for Brady's range of label printers.

Labels are shown per vial / tube size and in order of label width.

| Diagram             | Material | Special Properties | Label Width A (mm) | Label Height B (mm) | Label Length B (mm) | Diameter C (mm) | Printable Area Width PW (mm) | Printable Area Height PH (mm) | Order Reference         | Printer Compatibility | Printer Ribbon Series | Labels per Roll | Labels per Row |
|---------------------|----------|--------------------|--------------------|---------------------|---------------------|-----------------|------------------------------|-------------------------------|-------------------------|-----------------------|-----------------------|-----------------|----------------|
| <b>1.0 - 8.0 ml</b> |          |                    |                    |                     |                     |                 |                              |                               |                         |                       |                       |                 |                |
| ▶                   | B-461    | <b>FNAHSL</b>      | 15.24              | 41.28               | -                   | -               | 15.24                        | 25.40                         | M7-76-461               | M710                  | R6200                 | 500             | 1              |
| ▶                   | B-461    | <b>FNAHSL</b>      | 15.24              | 66.68               | -                   | -               | 15.24                        | 25.40                         | M7-86-461               | M710                  | R6200                 | 100             | 1              |
| ●                   | B-499    | <b>FNA</b>         | 19.05              | 23.80               | -                   | -               | -                            | -                             | B33-91-499              | i3300, i5300          | B30 Monocolour        | 2500            | 4              |
| ▶                   | B-427    | <b>FN S</b>        | 19.05              | 44.45               | -                   | -               | 19.05                        | 12.70                         | B33-73-427              | i3300                 | B30 Monocolour        | 3500            | 4              |
| ▶                   | B-427    | <b>FN S</b>        | 19.05              | 44.45               | -                   | -               | 19.05                        | 12.70                         | THT-73-427-10           | BBP12, i7100, i5100   | R4300, R7950          | 10000           | 4              |
| ▶                   | B-427    | <b>FN S</b>        | 19.05              | 44.45               | -                   | -               | 19.05                        | 12.70                         | THT-62-427-3.5*         | BBP12, i7100, i5100   | R4300, R7950          | 3500            | 1              |
| ▲                   | B-427    | <b>FN S</b>        | 20.00              | 20.00               | -                   | -               | -                            | -                             | <b>BPTLAB-35-427-YL</b> | BBP12                 | R7950                 | 1000            | 1              |
| ⊗                   | B-499    | <b>F A</b>         | 22.86              | 12.70               | -                   | 12.70           | -                            | -                             | B33-126-499             | i3300                 | B30 Monocolour        | 1500            | 1              |
| ⊗                   | B-499    | <b>F A</b>         | 22.86              | 12.70               | -                   | 12.70           | -                            | -                             | M7-126-499              | M710                  | R4300                 | 500             | 1              |
| ⊗                   | B-499    | <b>F A</b>         | 22.86              | 12.70               | -                   | 12.70           | -                            | -                             | THT-126-499-3           | i7100, i5100          | R4900                 | 3000            | 1              |
| ▲                   | B-499    | <b>FNA</b>         | 22.86              | 12.70               | -                   | -               | -                            | -                             | M6-84-499               | M610, M611            | R4300, R6000HF, R6200 | 500             | 1              |
| ▶                   | B-427    | <b>FN S</b>        | 25.40              | 19.05               | -                   | -               | 25.40                        | 9.53                          | M21-18-427              | M210-LAB, M211        | R4300, R4500          | 1               | 1              |
| ●                   | B-492    | <b>FN H L</b>      | 25.40              | 19.05               | -                   | -               | -                            | -                             | THT-88-492-5            | BBP12, i7100, i5100   | R6400                 | 5000            | 2              |
| ▲                   | B-492    | <b>FN H L</b>      | 25.40              | 19.05               | -                   | -               | -                            | -                             | THT-88-492-2.5-SC       | BBP12                 | R6400                 | 2500            | 2              |
| ▲                   | B-499    | <b>FNA</b>         | 25.40              | 19.05               | -                   | -               | -                            | -                             | M21-18-499              | M210-LAB, M211        | R4300                 | 1               | 1              |
| ▲                   | B-423    | <b>F AH</b>        | 25.40              | 19.05               | -                   | -               | -                            | -                             | M21-18-423              | M210-LAB, M211        | R6000HF               | 1               | 1              |
| ▲                   | B-490    | <b>FN H L</b>      | 25.40              | 44.45               | -                   | -               | -                            | -                             | M6-203-490              | M610, M611            | R4300                 | 250             | 1              |
| ▶                   | B-461    | <b>FNAHSL</b>      | 25.40              | 66.68               | -                   | -               | 25.40                        | 25.40                         | M7-115-461              | M710                  | R6200                 | 100             | 1              |
| ⊗                   | B-492    | <b>F H L</b>       | 41.28              | 15.24               | -                   | 9.53            | -                            | -                             | B33-190-492             | i3300                 | B30 Monocolour        | 1500            | 1              |
| ⊗                   | B-492    | <b>F H L</b>       | 41.28              | 15.24               | -                   | 9.53            | -                            | -                             | THT-190-492-3           | BBP12, i7100, i5100   | R6400                 | 3000            | 1              |
| ▲                   | B-490    | <b>FN H L</b>      | 41.28              | 15.24               | -                   | -               | -                            | -                             | THT-155-490-3           | BBP12, i7100, i5100   | R4300, R7950          | 3000            | 1              |
| ▲                   | B-490    | <b>FN H L</b>      | 41.28              | 15.24               | -                   | -               | -                            | -                             | THT-155-490-1.5-SC      | BBP12                 | R7950                 | 1500            | 1              |
| ▲                   | B-492    | <b>FN H L</b>      | 41.28              | 15.24               | -                   | -               | -                            | -                             | THT-155-492-3           | BBP12, i7100, i5100   | R6400                 | 3000            | 1              |
| ▲                   | B-492    | <b>FN H L</b>      | 41.28              | 15.24               | -                   | -               | -                            | -                             | B33-155-492             | i3300                 | B30 Monocolour        | 1500            | 1              |
| ▲                   | B-490    | <b>FN H L</b>      | 41.28              | 15.24               | -                   | -               | -                            | -                             | B33-155-490             | i3300                 | B30 Monocolour        | 1500            | 1              |
| ▲                   | B-7600   | <b>FN H L</b>      | 41.28              | 15.24               | -                   | -               | -                            | -                             | THT-302-7600-3          | BBP12, i7100, i5100   | R6000HF               | 3000            | 1              |
| ▲                   | B-7600   | <b>FN H L</b>      | 41.28              | 15.24               | -                   | -               | -                            | -                             | THT-302-7600-1.5SC      | BBP12                 | R6000HF               | 1500            | 1              |
| ▲                   | B-494    | <b>FN H</b>        | 41.28              | 15.24               | -                   | -               | -                            | -                             | <b>B33-302-494-YL</b>   | i3300, i5300          | R6400                 | 1500            | 1              |
| ▲                   | B-494    | <b>FN H</b>        | 41.28              | 15.24               | -                   | -               | -                            | -                             | <b>B33-302-494-RD</b>   | i3300, i5300          | R6400                 | 1500            | 1              |
| ▲                   | B-494    | <b>FN H</b>        | 41.28              | 15.24               | -                   | -               | -                            | -                             | <b>B33-302-494-PK</b>   | i3300, i5300          | R6400                 | 1500            | 1              |
| ▲                   | B-494    | <b>FN H</b>        | 41.28              | 15.24               | -                   | -               | -                            | -                             | <b>B33-302-494-OR</b>   | i3300, i5300          | R6400                 | 1500            | 1              |
| ▲                   | B-494    | <b>FN H</b>        | 41.28              | 15.24               | -                   | -               | -                            | -                             | <b>B33-302-494-GN</b>   | i3300, i5300          | R6400                 | 1500            | 1              |
| ▲                   | B-494    | <b>FN H</b>        | 41.28              | 15.24               | -                   | -               | -                            | -                             | <b>B33-302-494-BL</b>   | i3300, i5300          | R6400                 | 1500            | 1              |
| ▲                   | B-490    | <b>FN H L</b>      | 41.28              | 15.24               | -                   | -               | -                            | -                             | M7-76-490               | M710                  | R4300                 | 500             | 1              |
| ▲                   | B-492    | <b>FN H L</b>      | 44.45              | 25.40               | -                   | -               | -                            | -                             | M-125-492               | BMP51                 | R6400                 | 180             | -              |
| ▲                   | B-490    | <b>FN H L</b>      | 48.26              | 25.40               | -                   | -               | -                            | -                             | THT-156-490-3           | BBP12, i7100, i5100   | R4300, R7950          | 3000            | 1              |
| ▲                   | B-490    | <b>FN H L</b>      | 48.26              | 25.40               | -                   | -               | -                            | -                             | THT-156-490-1.5-SC      | BBP12                 | R7950                 | 1500            | 1              |
| ▲                   | B-492    | <b>FN H L</b>      | 48.26              | 25.40               | -                   | -               | -                            | -                             | THT-156-492-1.5-SC      | BBP12                 | R6400                 | 1500            | 1              |
| ▲                   | B-490    | <b>FN H L</b>      | 48.26              | 25.40               | -                   | -               | -                            | -                             | B33-156-490             | i3300                 | B30 Monocolour        | 1500            | 1              |
| ▲                   | B-492    | <b>FN H L</b>      | 48.26              | 25.40               | -                   | -               | -                            | -                             | B33-156-492             | i3300                 | B30 Monocolour        | 1500            | 1              |
| ▲                   | B-499    | <b>FNA</b>         | 48.26              | 25.40               | -                   | -               | -                            | -                             | M7-78-499               | M710                  | R4300                 | 250             | 1              |
| ▲                   | B-7600   | <b>FN H L</b>      | 48.26              | 25.40               | -                   | -               | -                            | -                             | THT-303-7600-1.5SC      | BBP12                 | R6000HF               | 1500            | 1              |
| ▲                   | B-7600   | <b>FN H L</b>      | 48.26              | 25.40               | -                   | -               | -                            | -                             | THT-303-7600-3          | BBP12, i7100, i5100   | R6000HF               | 3000            | 1              |
| ▲                   | B-494    | <b>FN H</b>        | 48.26              | 25.40               | -                   | -               | -                            | -                             | <b>THT-303-494-3-YL</b> | i5100, i7100          | R6400                 | 3000            | 1              |
| ▲                   | B-494    | <b>FN H</b>        | 48.26              | 25.40               | -                   | -               | -                            | -                             | <b>THT-303-494-3-RD</b> | i5100, i7100          | R6400                 | 3000            | 1              |
| ▲                   | B-494    | <b>FN H</b>        | 48.26              | 25.40               | -                   | -               | -                            | -                             | <b>THT-303-494-3-PK</b> | i5100, i7100          | R6400                 | 3000            | 1              |
| ▲                   | B-494    | <b>FN H</b>        | 48.26              | 25.40               | -                   | -               | -                            | -                             | <b>THT-303-494-3-OR</b> | i5100, i7100          | R6400                 | 3000            | 1              |
| ▲                   | B-494    | <b>FN H</b>        | 48.26              | 25.40               | -                   | -               | -                            | -                             | <b>THT-303-494-3-GN</b> | i5100, i7100          | R6400                 | 3000            | 1              |

\*Label is rotated 90° on liner.

\*\*AW = All White / no transparent area.



# Conical / Large Tube Labels

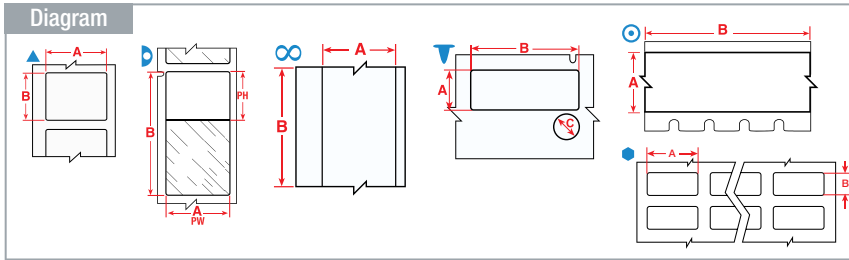

The background colours in the Order Reference column represent the material colour.

See page 58 for Brady's range of label printers.

Labels are shown per vial / tube size and in order of label width.

| Diagram              | Material | Special Properties | Label Width A (mm) | Label Height B (mm) | Label Length B (m) | Diameter C (mm) | Printable Area Width PW (mm) | Printable Area Height PH (mm) | Order Reference     | Printer Compatibility | Printer Ribbon Series | Labels per Roll | Labels per Row |
|----------------------|----------|--------------------|--------------------|---------------------|--------------------|-----------------|------------------------------|-------------------------------|---------------------|-----------------------|-----------------------|-----------------|----------------|
| <b>1.0 - 8.0 ml</b>  |          |                    |                    |                     |                    |                 |                              |                               |                     |                       |                       |                 |                |
| ▲                    | B-494    | <b>F N H</b>       | 48.26              | 25.40               | -                  | -               | -                            | -                             | THT-303-494-3-BL    | i5100, i7100          | R6400                 | 3000            | 1              |
| ▲                    | B-492    | <b>F N H L</b>     | 48.26              | 25.40               | -                  | -               | -                            | -                             | M7-78-492           | M710                  | R6400                 | 250             | 1              |
| ▲                    | B-492    | <b>F N H L</b>     | 48.26              | 25.40               | -                  | -               | -                            | -                             | THT-156-492-3       | BBP12, i7100, i5100   | R6400                 | 3000            | 1              |
| ▷                    | B-461    | <b>F N A H S L</b> | 66.68              | 25.40               | -                  | -               | 25.40                        | 25.40                         | THT-131-461-1.5-SC* | BBP12                 | R7950                 | 1500            | 1              |
| ▷                    | B-461    | <b>F N A H S L</b> | 66.68              | 25.40               | -                  | -               | 25.40                        | 25.40                         | BM-75-461           | M610, M611, M710      | R6200                 | 1000            | 1              |
| ▷                    | B-461    | <b>F N A H S L</b> | 66.68              | 25.40               | -                  | -               | 25.40                        | 25.40                         | THT-131-461-3*      | BBP12, i7100, i5100   | R4300, R7950          | 3000            | 1              |
| <b>1.0 - 15.0 ml</b> |          |                    |                    |                     |                    |                 |                              |                               |                     |                       |                       |                 |                |
| ▲                    | B-492    | <b>F N H L</b>     | 22.86              | 25.40               | -                  | -               | -                            | -                             | M-156-492           | BMP51                 | R6400                 | 180             | -              |
| <b>1.5 ml</b>        |          |                    |                    |                     |                    |                 |                              |                               |                     |                       |                       |                 |                |
| ○                    | B-499    | <b>F N A</b>       | 12.70              | -                   | 4.88               | -               | -                            | -                             | M21-500-499         | M210-LAB, M211        | R4300                 | 1               | -              |
| ○                    | B-499    | <b>F N A</b>       | 12.70              | -                   | 4.88               | -               | -                            | -                             | MC-500-499          | BMP41, BMP51          | R4300                 | 1               | -              |
| ○                    | B-461    | <b>F N A H S L</b> | 12.70              | -                   | 6.40               | -               | -                            | -                             | M21-500-461-AW**    | M210-LAB, M211        | R4300                 | 1               | -              |
| ○                    | B-499    | <b>F N A</b>       | 12.70              | -                   | 9.14               | -               | -                            | -                             | M7C-500-499         | M710                  | R4300, R6000HF, R6200 | 1               | 1              |
| ○                    | B-430    | <b>F A H</b>       | 12.70              | -                   | 15.24              | -               | -                            | -                             | M6C-500-430         | M610, M611            | R6000HF               | 1               | 1              |
| <b>1.5 - 2.0 ml</b>  |          |                    |                    |                     |                    |                 |                              |                               |                     |                       |                       |                 |                |
| ▲                    | B-492    | <b>F N H L</b>     | 12.70              | 41.91               | -                  | -               | -                            | -                             | M-124-492           | BMP51                 | R6400                 | 180             | -              |
| ▲                    | B-492    | <b>F N H L</b>     | 25.40              | 12.70               | -                  | -               | -                            | -                             | THT-59-492-2.5-SC   | BBP12                 | R6400                 | 2500            | 1              |
| ▲                    | B-492    | <b>F N H L</b>     | 25.40              | 12.70               | -                  | -               | -                            | -                             | B33-59-492          | i3300                 | B30 Monocolour        | 2500            | 1              |
| ◆                    | B-430    | <b>F A H</b>       | 25.40              | 12.70               | -                  | -               | -                            | -                             | THT-39-430-10       | BBP12, i7100, i5100   | R6000HF               | 10000           | 3              |
| ▲                    | B-7600   | <b>F N H L</b>     | 25.40              | 12.70               | -                  | -               | -                            | -                             | THT-310-7600-2.5SC  | BBP12                 | R6000HF               | 2500            | 1              |
| ▲                    | B-7600   | <b>F N H L</b>     | 25.40              | 12.70               | -                  | -               | -                            | -                             | THT-310-7600-10     | BBP12, i7100, i5100   | R6000HF               | 10000           | 1              |
| ▲                    | B-494    | <b>F N H</b>       | 25.40              | 12.70               | -                  | -               | -                            | -                             | THT-310-494-10-YL   | i5100, i7100          | R6400                 | 10000           | 1              |
| ▲                    | B-494    | <b>F N H</b>       | 25.40              | 12.70               | -                  | -               | -                            | -                             | THT-310-494-10-RD   | i5100, i7100          | R6400                 | 10000           | 1              |
| ▲                    | B-494    | <b>F N H</b>       | 25.40              | 12.70               | -                  | -               | -                            | -                             | THT-310-494-10-PK   | i5100, i7100          | R6400                 | 10000           | 1              |
| ▲                    | B-494    | <b>F N H</b>       | 25.40              | 12.70               | -                  | -               | -                            | -                             | THT-310-494-10-OR   | i5100, i7100          | R6400                 | 10000           | 1              |
| ▲                    | B-494    | <b>F N H</b>       | 25.40              | 12.70               | -                  | -               | -                            | -                             | THT-310-494-10-GN   | i5100, i7100          | R6400                 | 10000           | 1              |
| ▲                    | B-494    | <b>F N H</b>       | 25.40              | 12.70               | -                  | -               | -                            | -                             | THT-310-494-10-BL   | i5100, i7100          | R6400                 | 10000           | 1              |
| ▲                    | B-494    | <b>F N H</b>       | 25.40              | 12.70               | -                  | -               | -                            | -                             | BPT-310-494-2.5-YL  | BBP12                 | R6400                 | 2500            | 1              |
| ▲                    | B-494    | <b>F N H</b>       | 25.40              | 12.70               | -                  | -               | -                            | -                             | BPT-310-494-2.5-RD  | BBP12                 | R6400                 | 2500            | 1              |
| ▲                    | B-494    | <b>F N H</b>       | 25.40              | 12.70               | -                  | -               | -                            | -                             | BPT-310-494-2.5-PK  | BBP12                 | R6400                 | 2500            | 1              |
| ▲                    | B-494    | <b>F N H</b>       | 25.40              | 12.70               | -                  | -               | -                            | -                             | BPT-310-494-2.5-OR  | BBP12                 | R6400                 | 2500            | 1              |
| ▲                    | B-494    | <b>F N H</b>       | 25.40              | 12.70               | -                  | -               | -                            | -                             | BPT-310-494-2.5-GN  | BBP12                 | R6400                 | 2500            | 1              |
| ▲                    | B-494    | <b>F N H</b>       | 25.40              | 12.70               | -                  | -               | -                            | -                             | BPT-310-494-2.5-BL  | BBP12                 | R6400                 | 2500            | 1              |
| ▲                    | B-494    | <b>F N H</b>       | 25.40              | 12.70               | -                  | -               | -                            | -                             | B33-310-494-YL      | i3300, i5300          | R6400                 | 2500            | 1              |
| ▲                    | B-494    | <b>F N H</b>       | 25.40              | 12.70               | -                  | -               | -                            | -                             | B33-310-494-RD      | i3300, i5300          | R6400                 | 2500            | 1              |
| ▲                    | B-494    | <b>F N H</b>       | 25.40              | 12.70               | -                  | -               | -                            | -                             | B33-310-494-PK      | i3300, i5300          | R6400                 | 2500            | 1              |
| ▲                    | B-494    | <b>F N H</b>       | 25.40              | 12.70               | -                  | -               | -                            | -                             | B33-310-494-OR      | i3300, i5300          | R6400                 | 2500            | 1              |
| ▲                    | B-494    | <b>F N H</b>       | 25.40              | 12.70               | -                  | -               | -                            | -                             | B33-310-494-GN      | i3300, i5300          | R6400                 | 2500            | 1              |
| ▲                    | B-494    | <b>F N H</b>       | 25.40              | 12.70               | -                  | -               | -                            | -                             | B33-310-494-BL      | i3300, i5300          | R6400                 | 2500            | 1              |
| ▲                    | B-492    | <b>F N H L</b>     | 25.40              | 12.70               | -                  | -               | -                            | -                             | THT-59-492-10       | BBP12, i7100, i5100   | R6400                 | 10000           | 1              |
| ▼                    | B-492    | <b>F H L</b>       | 41.28              | 15.24               | -                  | 9.53            | -                            | -                             | M-95-492            | BMP51                 | R6400                 | 200             | -              |
| ▷                    | B-461    | <b>F N A H S L</b> | 41.28              | 15.24               | -                  | -               | 15.24                        | 15.24                         | THT-133-461-1.5-SC* | BBP12                 | R7950                 | 1500            | 1              |
| ▷                    | B-461    | <b>F N A H S L</b> | 41.29              | 15.24               | -                  | -               | 25.40                        | 15.24                         | B33-133-461         | i3300                 | B30 Monocolour        | 1500            | 3              |
| ▷                    | B-461    | <b>F N A H S L</b> | 41.29              | 15.24               | -                  | -               | 25.40                        | 15.24                         | THT-133-461-3*      | BBP12, i7100, i5100   | R4300, R7950          | 3000            | 1              |
| ▷                    | B-461    | <b>F N A H S L</b> | 66.68              | 15.24               | -                  | -               | 25.40                        | 15.24                         | THT-153-461-1.5-SC* | BBP12                 | R7950                 | 1500            | 1              |
| ▷                    | B-461    | <b>F N A H S L</b> | 66.68              | 15.24               | -                  | -               | 25.40                        | 15.24                         | THT-153-461-3*      | BBP12, i7100, i5100   | R4300, R7950          | 3000            | 1              |

\*Label is rotated 90° on liner.



**F** Freezer environment **N** Liquid nitrogen environment **A** Autoclave environment **H** Hot water bath (100°C) **S** Self-laminating label **L** Low-profile (extremely thin) label **R** Removable

# Conical / Large Tube Labels

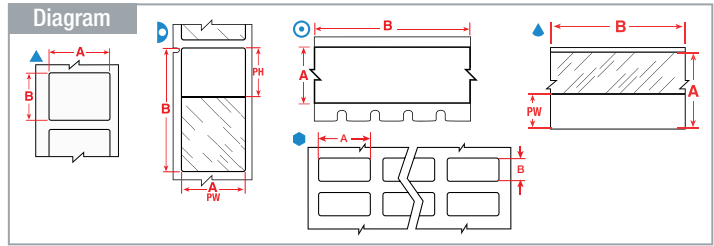

The background colours in the Order Reference column represent the material colour.

See page 58 for Brady's range of label printers.

Labels are shown per vial / tube size and in order of label width.

| Diagram               | Material | Special Properties | Label Width A (mm) | Label Height B (mm) | Label Length B (m) | Diameter C (mm) | Printable Area Width PW (mm) | Printable Area Height PH (mm) | Order Reference  | Printer Compatibility | Printer Ribbon Series | Labels per Roll | Labels per Row |
|-----------------------|----------|--------------------|--------------------|---------------------|--------------------|-----------------|------------------------------|-------------------------------|------------------|-----------------------|-----------------------|-----------------|----------------|
| <b>1.5 - 8.0 ml</b>   |          |                    |                    |                     |                    |                 |                              |                               |                  |                       |                       |                 |                |
| ●                     | B-492    | <b>F N H L</b>     | 25.40              | 9.53                | -                  | -               | -                            | -                             | B33-152-492      | i3300                 | B30 Monocolour        | 2500            | 2              |
| <b>2.0 - 4.0 ml</b>   |          |                    |                    |                     |                    |                 |                              |                               |                  |                       |                       |                 |                |
| ▶                     | B-461    | <b>F N A H S L</b> | 15.24              | 48.26               | -                  | -               | 15.24                        | 39.88                         | BPT-638-461*     | BBP12                 | R7950                 | 2000            | 1              |
| ▶                     | B-461    | <b>F N A H S L</b> | 15.24              | 48.26               | -                  | -               | 15.24                        | 39.88                         | B33-638-461*     | i3300                 | B30-R4300             | 2000            | 1              |
| ▶                     | B-461    | <b>F N A H S L</b> | 15.24              | 48.26               | -                  | -               | 15.24                        | 40.00                         | M7-119-461       | M710                  | R6200                 | 500             | 1              |
| <b>2.0 - 8.0 ml</b>   |          |                    |                    |                     |                    |                 |                              |                               |                  |                       |                       |                 |                |
| ●                     | B-499    | <b>F N A</b>       | 25.40              | 19.05               | -                  | -               | -                            | -                             | B33-88-499       | i3300, i5300          | B30 Monocolour        | 2500            | 2              |
| ▲                     | B-494    | <b>F N H</b>       | 25.40              | 25.40               | -                  | -               | 25.40                        | 22.23                         | THT-179-494-YL   | i7100, i5100, BBP12   | R6400                 | 3000            | 1              |
| ▲                     | B-494    | <b>F N H</b>       | 25.40              | 25.40               | -                  | -               | 25.40                        | 22.23                         | THT-179-494-RD   | i7100, i5100, BBP12   | R6400                 | 3000            | 1              |
| ▲                     | B-494    | <b>F N H</b>       | 25.40              | 25.40               | -                  | -               | 25.40                        | 22.23                         | THT-179-494-BL   | i7100, i5100, BBP12   | R6400                 | 3000            | 1              |
| ▲                     | B-494    | <b>F N H</b>       | 25.40              | 25.40               | -                  | -               | 25.40                        | 22.23                         | THT-179-494-OR   | i7100, i5100, BBP12   | R6400                 | 3000            | 1              |
| ▲                     | B-494    | <b>F N H</b>       | 25.40              | 25.40               | -                  | -               | 25.40                        | 22.23                         | THT-179-494-GN   | i7100, i5100, BBP12   | R6400                 | 3000            | 1              |
| ▲                     | B-494    | <b>F N H</b>       | 25.40              | 25.40               | -                  | -               | 25.40                        | 22.23                         | THT-179-494-PK   | i7100, i5100, BBP12   | R6400                 | 3000            | 1              |
| ▲                     | B-492    | <b>F N H L</b>     | 25.40              | 25.40               | -                  | -               | -                            | -                             | B33-179-492      | i3300                 | B30 Monocolour        | 1900            | 1              |
| <b>2.0 - 50.0 ml</b>  |          |                    |                    |                     |                    |                 |                              |                               |                  |                       |                       |                 |                |
| ▲                     | B-427    | <b>F N S</b>       | 19.05              | -                   | 4.30               | -               | 9.53                         | -                             | M21-750-427      | M210-LAB, M211        | R4300                 | 1               | -              |
| ○                     | B-499    | <b>F N A</b>       | 19.05              | -                   | 4.88               | -               | -                            | -                             | M21-750-499      | M210-LAB, M211        | R4300                 | 1               | -              |
| ○                     | B-499    | <b>F N A</b>       | 19.05              | -                   | 4.88               | -               | -                            | -                             | MC-750-499       | BMP41, BMP51          | R4300                 | 1               | -              |
| ○                     | B-461    | <b>F N A H S L</b> | 19.05              | -                   | 6.40               | -               | -                            | -                             | M21-750-461-AW** | M210-LAB, M211        | R4300                 | 1               | -              |
| ▲                     | B-427    | <b>F N S</b>       | 19.05              | -                   | 7.62               | -               | 9.53                         | -                             | MC-750-427       | BMP41, BMP51          | R4300                 | 1               | -              |
| ▲                     | B-427    | <b>F N S</b>       | 25.40              | -                   | 4.30               | -               | 9.53                         | -                             | M21-1000-427     | M210-LAB, M211        | R4300                 | 1               | -              |
| ○                     | B-499    | <b>F N A</b>       | 25.40              | -                   | 4.88               | -               | -                            | -                             | MC-1000-499      | BMP51                 | R4300                 | 1               | -              |
| ▲                     | B-427    | <b>F N S</b>       | 25.40              | -                   | 7.62               | -               | 9.53                         | -                             | MC-1000-427      | BMP51                 | R4300                 | 1               | -              |
| ○                     | B-461    | <b>F N A H S L</b> | 25.40              | -                   | 7.62               | -               | -                            | -                             | MC-1000-461-AW** | BMP51                 | R4300                 | 1               | -              |
| ○                     | B-499    | <b>F N A</b>       | 25.40              | -                   | 9.14               | -               | -                            | -                             | M7C-1000-499     | M710                  | R4300, R6000HF, R6200 | 1               | 1              |
| <b>4.0 - 8.0 ml</b>   |          |                    |                    |                     |                    |                 |                              |                               |                  |                       |                       |                 |                |
| ●                     | B-499    | <b>F N A</b>       | 25.40              | 66.68               | -                  | -               | -                            | -                             | BPT-625-499      | BBP12                 | R7950                 | 1500            | 3              |
| ●                     | B-499    | <b>F N A</b>       | 25.40              | 66.68               | -                  | -               | -                            | -                             | B33-625-499      | i3300                 | B30-R6000HF           | 1500            | 3              |
| <b>4.0 - 50.0 ml</b>  |          |                    |                    |                     |                    |                 |                              |                               |                  |                       |                       |                 |                |
| ▲                     | B-427    | <b>F N S</b>       | 31.75              | -                   | 4.30               | -               | 12.70                        | -                             | M21-1250-427     | M210-LAB, M211        | R4300                 | 1               | -              |
| ▲                     | B-427    | <b>F N S</b>       | 31.75              | -                   | 7.62               | -               | 12.70                        | -                             | MC-1250-427      | BMP51                 | R4300                 | 1               | -              |
| ○                     | B-461    | <b>F N A H S L</b> | 31.75              | -                   | 7.62               | -               | -                            | -                             | MC-1250-461-AW** | BMP51                 | R4300                 | 1               | -              |
| ▶                     | B-461    | <b>F N A H S L</b> | 34.93              | 45.72               | -                  | -               | 34.93                        | 39.88                         | BPT-632-461*     | BBP12                 | R7950                 | 2000            | 1              |
| ▶                     | B-461    | <b>F N A H S L</b> | 34.93              | 45.72               | -                  | -               | 34.93                        | 39.88                         | B33-632-461*     | i3300                 | B30-R4300             | 1500            | 1              |
| <b>5.0 - 50.0 ml</b>  |          |                    |                    |                     |                    |                 |                              |                               |                  |                       |                       |                 |                |
| ▲                     | B-427    | <b>F N S</b>       | 38.10              | -                   | 4.30               | -               | 12.70                        | -                             | M21-1500-427     | M210-LAB, M211        | R4300                 | 1               | -              |
| ▲                     | B-427    | <b>F N S</b>       | 38.10              | -                   | 7.62               | -               | 12.70                        | -                             | MC-1500-427      | BMP51                 | R4300                 | 1               | -              |
| ○                     | B-499    | <b>F N A</b>       | 48.26              | -                   | 9.14               | -               | -                            | -                             | M7C-1900-499     | M710                  | R4300, R6000HF, R6200 | 1               | 1              |
| <b>12.0 - 14.0 ml</b> |          |                    |                    |                     |                    |                 |                              |                               |                  |                       |                       |                 |                |
| ▶                     | B-461    | <b>F N A H S L</b> | 95.25              | 38.10               | -                  | -               | 31.75                        | 38.10                         | M-119-461        | BMP51                 | R4300                 | 80              | -              |
| <b>12.0 - 24.0 ml</b> |          |                    |                    |                     |                    |                 |                              |                               |                  |                       |                       |                 |                |
| ●                     | B-499    | <b>F N A</b>       | 12.70              | 36.50               | -                  | -               | -                            | -                             | B33-87-499       | i3300, i5300          | B30 Monocolour        | 2500            | 6              |
| ▲                     | B-499    | <b>F N A</b>       | 12.70              | 38.10               | -                  | -               | -                            | -                             | M7-29-499        | M710                  | R6200                 | 500             | 1              |
| ▲                     | B-499    | <b>F N A</b>       | 12.70              | 38.10               | -                  | -               | -                            | -                             | M6-29-499        | M610, M611            | R4300, R6000HF, R6200 | 500             | 1              |
| ▲                     | B-498    | <b>F R</b>         | 12.70              | 38.10               | -                  | -               | -                            | -                             | BM-29-498        | M610, M611, M710      | R6200                 | 5000            | 1              |
| ▲                     | B-492    | <b>F N H L</b>     | 25.40              | 48.26               | -                  | -               | -                            | -                             | M-78-492         | BMP51                 | R6400                 | 100             | -              |

\*Label is rotated 90° on liner.

\*\*AW = All White / no transparent area.

>>>

# Conical / Large Tube Labels

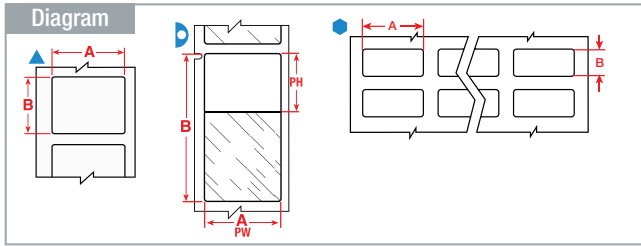

The background colours in the Order Reference column represent the material colour.

See page 58 for Brady's range of label printers.

Labels are shown per vial / tube size and in order of label width.

| Diagram               | Material | Special Properties | Label Width A (mm) | Label Height B (mm) | Label Length B (m) | Diameter C (mm) | Printable Area Width PW (mm) | Printable Area Height PH (mm) | Order Reference    | Printer Compatibility | Printer Ribbon Series | Labels per Roll | Labels per Row |
|-----------------------|----------|--------------------|--------------------|---------------------|--------------------|-----------------|------------------------------|-------------------------------|--------------------|-----------------------|-----------------------|-----------------|----------------|
| <b>12.0 - 24.0 ml</b> |          |                    |                    |                     |                    |                 |                              |                               |                    |                       |                       |                 |                |
| ▲                     | B-498    | <b>F</b> <b>R</b>  | 38.10              | 12.70               | -                  | -               | -                            | -                             | M7-29-498          | M710                  | R6200                 | 500             | 1              |
| ▲                     | B-498    | <b>F</b> <b>R</b>  | 38.10              | 12.70               | -                  | -               | -                            | -                             | M6-29-498          | M610, M611            | R6200                 | 500             | 1              |
| ▲                     | B-499    | <b>FNA</b>         | 38.10              | 31.75               | -                  | -               | -                            | -                             | M-132-499          | BMP51                 | R4300                 | 160             | -              |
| ▲                     | B-499    | <b>FNA</b>         | 50.80              | 19.05               | -                  | -               | -                            | -                             | M21-137-499        | M210-LAB, M211        | R4300                 | 1               | 1              |
| ▲                     | B-423    | <b>F AH</b>        | 50.80              | 19.05               | -                  | -               | -                            | -                             | M21-137-423        | M210-LAB, M211        | R6000HF               | 1               | 1              |
| ▷                     | B-461    | <b>FNAHSL</b>      | 88.90              | 38.10               | -                  | -               | 25.40                        | 15.24                         | M6-77-461          | M610, M611            | R4300                 | 100             | 1              |
| <b>12.0 - 50.0 ml</b> |          |                    |                    |                     |                    |                 |                              |                               |                    |                       |                       |                 |                |
| ●                     | B-498    | <b>F</b> <b>R</b>  | 25.40              | 101.60              | -                  | -               | -                            | -                             | B33-326-498        | i3300, i5300          | B30 Monocolour        | 450             | 2              |
| ●                     | B-499    | <b>FNA</b>         | 25.40              | 101.60              | -                  | -               | -                            | -                             | B33-326-499        | i3300, i5300          | B30 Monocolour        | 450             | 2              |
| ▷                     | B-461    | <b>FNAHSL</b>      | 133.35             | 25.40               | -                  | -               | 25.40                        | 25.40                         | B33-139-461        | i3300                 | B30 Monocolour        | 650             | 2              |
| ▷                     | B-461    | <b>FNAHSL</b>      | 133.35             | 25.40               | -                  | -               | 25.40                        | 25.40                         | THT-139-461-2      | BBP12, i7100, i5100   | R4300, R7950          | 2000            | 2              |
| <b>14.0 - 15.0 ml</b> |          |                    |                    |                     |                    |                 |                              |                               |                    |                       |                       |                 |                |
| ▲                     | B-499    | <b>FNA</b>         | 38.10              | 19.05               | -                  | -               | -                            | -                             | M21-136-499        | M210-LAB, M211        | R4300                 | 1               | 1              |
| ▲                     | B-423    | <b>F AH</b>        | 38.10              | 19.05               | -                  | -               | -                            | -                             | M21-30-423         | M210-LAB, M211        | R6000HF               | 1               | 1              |
| ▲                     | B-490    | <b>FNHL</b>        | 38.10              | 55.88               | -                  | -               | -                            | -                             | M-113-490          | BMP51                 | R4300                 | 140             | -              |
| ▲                     | B-490    | <b>FNHL</b>        | 38.10              | 55.88               | -                  | -               | -                            | -                             | M6-113-490         | M610, M611            | R4300                 | 100             | 1              |
| ▷                     | B-427    | <b>FNS</b>         | 38.10              | 63.50               | -                  | -               | 38.10                        | 19.05                         | M-116-427          | BMP51                 | R4300                 | 80              | -              |
| ▷                     | B-427    | <b>FNS</b>         | 38.10              | 63.50               | -                  | -               | 38.10                        | 19.05                         | BPT-517-427        | BBP12                 | R7950                 | 2000            | 2              |
| ▷                     | B-427    | <b>FNS</b>         | 38.10              | 63.50               | -                  | -               | 38.10                        | 19.05                         | B33-517-427        | i3300                 | B30-R4300             | 1000            | 2              |
| ▲                     | B-490    | <b>FNHL</b>        | 55.88              | 38.10               | -                  | -               | -                            | -                             | THT-157-490-3      | BBP12, i7100, i5100   | R4300, R7950          | 3000            | 1              |
| ▲                     | B-490    | <b>FNHL</b>        | 55.88              | 38.10               | -                  | -               | -                            | -                             | THT-157-490-1.5-SC | BBP12                 | R7950                 | 1500            | 1              |
| ▷                     | B-461    | <b>FNAHSL</b>      | 57.15              | 38.10               | -                  | -               | 31.75                        | 38.10                         | M-129-461          | BMP51                 | R4300                 | 140             | -              |
| <b>15.0 - 50.0 ml</b> |          |                    |                    |                     |                    |                 |                              |                               |                    |                       |                       |                 |                |
| ●                     | B-498    | <b>F</b> <b>R</b>  | 20.32              | 36.50               | -                  | -               | -                            | -                             | B33-95-498         | i3300                 | B30 Monocolour        | 2300            | 3              |
| ●                     | B-499    | <b>FNA</b>         | 20.32              | 36.50               | -                  | -               | -                            | -                             | B33-165-499        | i3300                 | B30 Monocolour        | 2500            | 4              |
| ●                     | B-499    | <b>FNA</b>         | 20.32              | 36.50               | -                  | -               | -                            | -                             | THT-69-499-3       | BBP12, i7100, i5100   | R4900                 | 3000            | 2              |
| ●                     | B-498    | <b>F</b> <b>R</b>  | 20.32              | 36.50               | -                  | -               | -                            | -                             | THT-95-498-5       | BBP12, i7100, i5100   | R4300, R7950          | 5000            | 3              |
| ●                     | B-499    | <b>FNA</b>         | 22.86              | 38.10               | -                  | -               | -                            | -                             | BPT-618-499        | BBP12                 | R7950                 | 3000            | 3              |
| ●                     | B-499    | <b>FNA</b>         | 25.40              | 36.50               | -                  | -               | -                            | -                             | B33-89-499         | i3300, i5300          | B30 Monocolour        | 2300            | 3              |
| ●                     | B-498    | <b>F</b> <b>R</b>  | 25.40              | 36.50               | -                  | -               | -                            | -                             | BPT-621-498        | BBP12                 | R7950                 | 3000            | 3              |
| ●                     | B-499    | <b>FNA</b>         | 25.40              | 36.50               | -                  | -               | -                            | -                             | BPT-621-499        | BBP12                 | R7950                 | 3000            | 3              |
| ●                     | B-499    | <b>FNA</b>         | 25.40              | 36.50               | -                  | -               | -                            | -                             | B33-621-499        | i3300                 | B30-R6000HF           | 3000            | 3              |
| ●                     | B-498    | <b>F</b> <b>R</b>  | 25.40              | 36.50               | -                  | -               | -                            | -                             | THT-89-498-5       | BBP12, i7100, i5100   | R4300, R7950          | 5000            | 3              |
| ▷                     | B-461    | <b>FNAHSL</b>      | 38.10              | 19.05               | -                  | -               | 38.10                        | 19.05                         | BPT-629-461*       | BBP12                 | R7950                 | 2500            | 2              |
| ▲                     | B-461    | <b>FNAHL</b>       | 48.26              | 25.40               | -                  | -               | 48.26                        | -                             | BPT-636-461-AW**   | BBP12                 | R7950                 | 2000            | 1              |
| ▲                     | B-461    | <b>FNAHL</b>       | 48.26              | 25.40               | -                  | -               | 48.26                        | -                             | B33-636-461AW**    | i3300                 | B30-R4300             | 2000            | 1              |
| ▲                     | B-427    | <b>FN</b>          | 55.88              | 38.10               | -                  | -               | 55.88                        | -                             | BPT-640-427-AW**   | BBP12                 | R7950                 | 2000            | 1              |
| ▲                     | B-427    | <b>FN</b>          | 55.88              | 38.10               | -                  | -               | 55.88                        | -                             | B33-640-427AW**    | i3300                 | B30-R4300             | 1500            | 1              |
| ▲                     | B-461    | <b>FNAHL</b>       | 57.15              | 19.05               | -                  | -               | 57.15                        | -                             | BPT-642-461-AW**   | BBP12                 | R7950                 | 2000            | 1              |
| ▲                     | B-461    | <b>FNAHL</b>       | 57.15              | 19.05               | -                  | -               | 57.15                        | -                             | B33-642-461AW**    | i3300                 | B30-R4300             | 2000            | 1              |
| ▷                     | B-461    | <b>FNAHSL</b>      | 66.68              | 25.40               | -                  | -               | 25.40                        | 25.40                         | B33-276-461        | i3300                 | B30 Monocolour        | 1500            | 2              |
| ▲                     | B-427    | <b>FN</b>          | 66.68              | 25.40               | -                  | -               | 66.68                        | -                             | BPT-648-427-AW**   | BBP12                 | R7950                 | 2000            | 1              |
| ▲                     | B-427    | <b>FN</b>          | 66.68              | 25.40               | -                  | -               | 66.68                        | -                             | B33-648-427AW**    | i3300                 | B30-R4300             | 1500            | 1              |
| ▷                     | B-461    | <b>FNAHSL</b>      | 88.90              | 38.10               | -                  | -               | 88.90                        | 38.10                         | B33-134-461*       | i3300                 | B30 Monocolour        | 1000            | 1              |
| ▷                     | B-461    | <b>FNAHSL</b>      | 88.90              | 38.10               | -                  | -               | 88.90                        | 38.10                         | THT-134-461*-3*    | BBP12, i7100, i5100   | R4300, R7950          | 3000            | 1              |
| ▲                     | B-461    | <b>FNAHL</b>       | 88.90              | 38.10               | -                  | -               | 88.90                        | -                             | BPT-650-461-AW**   | BBP12                 | R7950                 | 2000            | 1              |
| ▲                     | B-461    | <b>FNAHL</b>       | 88.90              | 38.10               | -                  | -               | 88.90                        | -                             | B33-650-461AW**    | i3300                 | B30-R4300             | 2000            | 1              |

\*Label is rotated 90° on liner.

\*\*AW = All White / no transparent area.

>>>

**F** Freezer environment **N** Liquid nitrogen environment **A** Autoclave environment **H** Hot water bath (100°C) **S** Self-laminating label **L** Low-profile (extremely thin) label **R** Removable

# Conical / Large Tube Labels

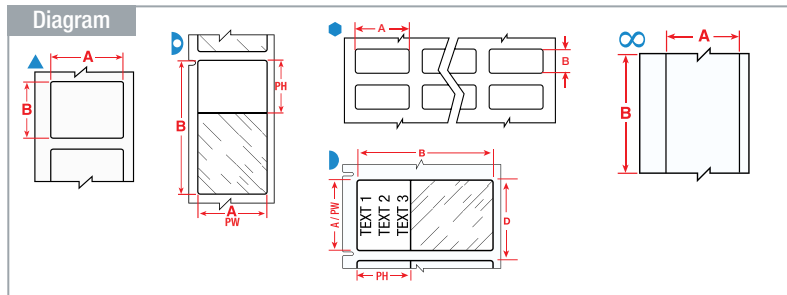

The background colours in the Order Reference column represent the material colour.

See page 58 for Brady's range of label printers.

Labels are shown per vial / tube size and in order of label width.

| Diagram        | Material | Special Properties | Label Width A (mm) | Label Height B (mm) | Label Length B (m) | Diameter C (mm) | Printable Area Width PW (mm) | Printable Area Height PH (mm) | Order Reference    | Printer Compatibility | Printer Ribbon Series               | Labels per Roll | Labels per Row |
|----------------|----------|--------------------|--------------------|---------------------|--------------------|-----------------|------------------------------|-------------------------------|--------------------|-----------------------|-------------------------------------|-----------------|----------------|
| <b>50.0 ml</b> |          |                    |                    |                     |                    |                 |                              |                               |                    |                       |                                     |                 |                |
| ▲              | B-423    | F AH               | 12.70              | 12.70               | -                  | -               | -                            | -                             | M7-7-423           | M710                  | R6000HF                             | 500             | 1              |
| ▲              | B-423    | F A                | 12.70              | 12.70               | -                  | -               | -                            | -                             | M6-7-423           | M610, M611            | R6000HF                             | 500             | 1              |
| ▲              | B-423    | F AH               | 12.70              | 12.70               | -                  | -               | -                            | -                             | BM-7-423           | M610, M611, M710      | R6000HF                             | 5000            | 1              |
| ▲              | B-498    | F R                | 19.05              | 19.05               | -                  | -               | -                            | -                             | B33-254-498        | i3300, i5300          | B30 Monocolour                      | 1000            | 1              |
| ▲              | B-499    | F NA               | 19.05              | 19.05               | -                  | -               | -                            | -                             | B33-254-499        | i3300, i5300          | B30 Monocolour                      | 1000            | 1              |
| ▷              | B-427    | F N S              | 19.05              | 38.10               | -                  | -               | 19.05                        | 12.70                         | M-90-427           | BMP41, BMP51          | R4300                               | 180             | -              |
| ▷              | B-427    | F N S              | 19.05              | 38.10               | -                  | -               | 19.05                        | 12.70                         | M7-30-427          | M710                  | R4300                               | 250             | 1              |
| ▷              | B-427    | F N S              | 19.05              | 38.10               | -                  | -               | 19.05                        | 12.70                         | BM-30-427          | M610, M611, M710      | R4300                               | 2500            | 1              |
| ▷              | B-461    | F NAHSL            | 19.05              | 38.10               | -                  | -               | 19.05                        | 33.02                         | B33-629-461*       | i3300                 | B30-R4300                           | 2500            | 2              |
| ▲              | B-499    | F NA               | 19.05              | 38.10               | -                  | -               | -                            | -                             | M7-30-499          | M710                  | R4300                               | 250             | 1              |
| ▲              | B-492    | F N H L            | 22.86              | 25.40               | -                  | -               | -                            | -                             | THT-180-492-3      | BBP12, i7100, i5100   | R6400                               | 3000            | 1              |
| ▲              | B-423    | F AH               | 25.40              | 4.75                | -                  | -               | -                            | -                             | M7-14-423          | M710                  | R6000HF                             | 750             | 1              |
| ▲              | B-423    | F A                | 25.40              | 4.75                | -                  | -               | -                            | -                             | M6-14-423          | M610, M611            | R6000HF                             | 750             | 1              |
| ●              | B-423    | F AH               | 25.40              | 4.75                | -                  | -               | -                            | -                             | THT-41-423-10      | BBP12, i7100, i5100   | R6000HF                             | 10000           | 3              |
| ●              | B-423    | F AH               | 25.40              | 6.35                | -                  | -               | -                            | -                             | THT-51-423-10      | BBP12, i7100, i5100   | R6000HF                             | 10000           | 3              |
| ▲              | B-423    | F AH               | 25.40              | 6.99                | -                  | -               | -                            | -                             | M7-15-423          | M710                  | R6000HF                             | 750             | 1              |
| ▲              | B-423    | F A                | 25.40              | 6.99                | -                  | -               | -                            | -                             | M6-15-423          | M610, M611            | R6000HF                             | 750             | 1              |
| ●              | B-499    | F NA               | 25.40              | 12.70               | -                  | -               | -                            | -                             | B33-5-499          | i3300, i5300          | B30 Monocolour                      | 5000            | 3              |
| ▲              | B-498    | F R                | 25.40              | 12.70               | -                  | -               | -                            | -                             | M7-17-498          | M710                  | R6200                               | 500             | 1              |
| ▲              | B-423    | F AH               | 25.40              | 12.70               | -                  | -               | -                            | -                             | M7-17-423          | M710                  | R6000HF                             | 500             | 1              |
| ▲              | B-423    | F A                | 25.40              | 12.70               | -                  | -               | -                            | -                             | M6-17-423          | M610, M611            | R6000HF, R4400                      | 500             | 1              |
| ▲              | B-430    | F AH               | 25.40              | 12.70               | -                  | -               | -                            | -                             | M6-17-430          | M610, M611            | R6000HF                             | 500             | 1              |
| ▲              | B-498    | F R                | 25.40              | 12.70               | -                  | -               | -                            | -                             | M6-17-498          | M610, M611            | R6200                               | 500             | 1              |
| ▲              | B-492    | F N H L            | 25.40              | 12.70               | -                  | -               | -                            | -                             | M7-17-492          | M710                  | R6400                               | 500             | 1              |
| ▲              | B-7600   | F N H L            | 25.40              | 25.40               | -                  | -               | -                            | -                             | THT-305-7600-2.5SC | BBP12                 | R6000HF                             | 2500            | 1              |
| ▲              | B-7600   | F N H L            | 25.40              | 25.40               | -                  | -               | -                            | -                             | THT-305-7600-3     | BBP12, i7100, i5100   | R6000HF                             | 3000            | 1              |
| ▲              | B-492    | F N H L            | 25.40              | 25.40               | -                  | -               | -                            | -                             | THT-179-492-2.5-SC | BBP12                 | R6400                               | 2500            | 1              |
| ▲              | B-492    | F N H L            | 25.40              | 25.40               | -                  | -               | -                            | -                             | THT-179-492-3      | BBP12, i7100, i5100   | R6400                               | 3000            | 1              |
| ▷              | B-427    | F N S              | 25.40              | 38.10               | -                  | -               | 25.40                        | 12.70                         | M-91-427           | BMP41, BMP51          | R4300                               | 180             | -              |
| ▷              | B-427    | F N S              | 25.40              | 38.10               | -                  | -               | 25.40                        | 12.70                         | M7-31-427          | M710                  | R4300                               | 250             | 1              |
| ▷              | B-427    | F N S              | 25.40              | 38.10               | -                  | -               | 25.40                        | 12.70                         | BM-31-427          | M610, M611, M710      | R4300                               | 2500            | 1              |
| ▲              | B-499    | F NA               | 25.40              | 38.10               | -                  | -               | -                            | -                             | M7-31-499          | M710                  | R4300, R6000HF, R6200               | 250             | 1              |
| ▲              | B-498    | F R                | 25.40              | 38.10               | -                  | -               | -                            | -                             | M7-31-498          | M710                  | R6200                               | 250             | 1              |
| ▲              | B-423    | F AH               | 25.40              | 50.80               | -                  | -               | -                            | -                             | M7-20-423          | M710                  | R6000HF                             | 100             | 1              |
| ▲              | B-423    | F A                | 25.40              | 50.80               | -                  | -               | -                            | -                             | M6-20-423          | M610, M611            | R6000HF                             | 100             | 1              |
| ●              | B-498    | F R                | 25.40              | 63.50               | -                  | -               | -                            | -                             | B33-325-498        | i3300, i5300          | B30 Monocolour                      | 700             | 2              |
| ●              | B-499    | F NA               | 25.40              | 63.50               | -                  | -               | -                            | -                             | B33-325-499        | i3300, i5300          | B30 Monocolour                      | 700             | 2              |
| ▲              | B-499    | F NA               | 25.40              | 63.50               | -                  | -               | -                            | -                             | M7-21-499          | M710                  | R4300, R4500, R4900, R6000HF, R6200 | 100             | 1              |
| ∞              | B-439    | F                  | 25.40              | -                   | 15.24              | -               | -                            | -                             | M6C-1000-439       | M610, M611            | R6000HF                             | 1               | 1              |
| ∞              | B-439    | F                  | 25.40              | -                   | 15.24              | -               | -                            | -                             | M6C-1000-439-OR    | M610, M611            | R6000HF                             | 1               | 1              |
| ∞              | B-439    | F                  | 25.40              | -                   | 15.24              | -               | -                            | -                             | M6C-1000-439-RD    | M610, M611            | R6000HF                             | 1               | 1              |
| ∞              | B-439    | F                  | 25.40              | -                   | 15.24              | -               | -                            | -                             | M6C-1000-439-YL    | M610, M611            | R6000HF                             | 1               | 1              |
| ▲              | B-427    | F N                | 38.10              | 19.05               | -                  | -               | 38.10                        | 19.05                         | B33-135-427AW**    | i3300                 | B30 Monocolour                      | 1500            | 1              |

\*Label is rotated 90° on liner.

\*\*AW = All White / no transparent area.

>>

F Freezer environment N Liquid nitrogen environment A Autoclave environment H Hot water bath (100°C) S Self-laminating label L Low-profile (extremely thin) label R Removable

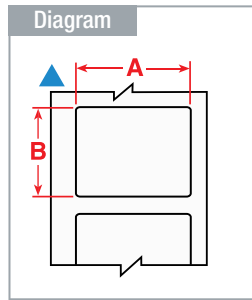

The background colours in the Order Reference column represent the material colour.

See page 58 for Brady's range of label printers.

Labels are shown per vial / tube size and in order of label width.

| Diagram        | Material | Special Properties | Label Width A (mm) | Label Height B (mm) | Label Length B (m) | Diameter C (mm) | Printable Area Width PW (mm) | Printable Area Height PH (mm) | Order Reference    | Printer Compatibility | Printer Ribbon Series | Labels per Roll | Labels per Row |
|----------------|----------|--------------------|--------------------|---------------------|--------------------|-----------------|------------------------------|-------------------------------|--------------------|-----------------------|-----------------------|-----------------|----------------|
| <b>50.0 ml</b> |          |                    |                    |                     |                    |                 |                              |                               |                    |                       |                       |                 |                |
| ▲              | B-499    | <b>F N A</b>       | 38.10              | 19.05               | -                  | -               | -                            | -                             | THT-136-499-1.5-SC | BBP12                 | R7950, R4300, R4900   | 1500            | 1              |
| ▲              | B-499    | <b>F N A</b>       | 38.10              | 19.05               | -                  | -               | -                            | -                             | B33-136-499        | i3300                 | B30 Monocolour        | 1500            | 1              |
| ▲              | B-427    | <b>F N</b>         | 38.10              | 19.05               | -                  | -               | -                            | -                             | M6-30-427-AW**     | M610, M611            | R4300                 | 250             | 1              |
| ▲              | B-499    | <b>F N A</b>       | 38.10              | 19.05               | -                  | -               | -                            | -                             | M6-30-499          | M610, M611            | R4300, R6000HF, R6200 | 250             | 1              |
| ▲              | B-427    | <b>F N S</b>       | 38.10              | 19.05               | -                  | -               | -                            | -                             | M7-30-427-AW**     | M710                  | R4300                 | 250             | 1              |
| ▲              | B-427    | <b>F N</b>         | 38.10              | 19.05               | -                  | -               | -                            | -                             | THT-135-427-3-AW** | BBP12, i7100, i5100   | R4300, R7950          | 3000            | 1              |
| ▲              | B-499    | <b>F N A</b>       | 38.10              | 19.05               | -                  | -               | -                            | -                             | THT-136-499-3      | BBP12, i7100, i5100   | R4900                 | 3000            | 1              |
| ▲              | B-423    | <b>F A H</b>       | 38.10              | 25.40               | -                  | -               | -                            | -                             | M7-31-423          | M710                  | R6000HF               | 250             | 1              |
| ▲              | B-423    | <b>F A</b>         | 38.10              | 25.40               | -                  | -               | -                            | -                             | M6-31-423          | M610, M611            | R6000HF               | 250             | 1              |
| ▲              | B-498    | <b>F R</b>         | 38.10              | 25.40               | -                  | -               | -                            | -                             | M6-31-498          | M610, M611            | R6200                 | 250             | 1              |
| ▲              | B-499    | <b>F N A</b>       | 38.10              | 25.40               | -                  | -               | -                            | -                             | M6-31-499          | M610, M611            | R4300, R6000HF, R6200 | 250             | 1              |
| ▲              | B-490    | <b>F N H L</b>     | 38.10              | 98.43               | -                  | -               | -                            | -                             | M-114-490          | BMP51                 | R4300                 | 80              | -              |
| ▲              | B-490    | <b>F N H L</b>     | 38.10              | 98.43               | -                  | -               | -                            | -                             | M6-114-490         | M610, M611            | R4300                 | 100             | 1              |
| ●              | B-498    | <b>F R</b>         | 38.10              | 101.60              | -                  | -               | -                            | -                             | B33-327-498        | i3300, i5300          | B30 Monocolour        | 450             | 2              |
| ●              | B-499    | <b>F N A</b>       | 38.10              | 101.60              | -                  | -               | -                            | -                             | B33-327-499        | i3300, i5300          | B30 Monocolour        | 450             | 2              |
| ●              | B-498    | <b>F R</b>         | 38.10              | 152.40              | -                  | -               | -                            | -                             | B33-328-498        | i3300, i5300          | B30 Monocolour        | 300             | 2              |
| ●              | B-499    | <b>F N A</b>       | 38.10              | 152.40              | -                  | -               | -                            | -                             | B33-328-499        | i3300, i5300          | B30 Monocolour        | 300             | 2              |
| ▲              | B-499    | <b>F N A</b>       | 48.26              | 25.40               | -                  | -               | -                            | -                             | M-128-499          | BMP41, BMP51          | R4300                 | 100             | -              |
| ▲              | B-427    | <b>F N</b>         | 48.26              | 25.40               | -                  | -               | -                            | -                             | M6-78-427-AW**     | M610, M611            | R4300                 | 250             | 1              |
| ▲              | B-488    | <b>F A</b>         | 48.26              | 25.40               | -                  | -               | -                            | -                             | M6-78-488          | M610, M611            | R4300                 | 250             | 1              |
| ▲              | B-499    | <b>F N A</b>       | 48.26              | 25.40               | -                  | -               | -                            | -                             | M6-78-499          | M610, M611            | R4300, R6000HF, R6200 | 250             | 1              |
| ▲              | B-490    | <b>F N H L</b>     | 50.80              | 6.35                | -                  | -               | -                            | -                             | B33-151-490        | i3300                 | B30 Monocolour        | 2500            | 1              |
| ▲              | B-427    | <b>F N</b>         | 50.80              | 25.40               | -                  | -               | 50.80                        | 25.40                         | B33-137-427AW**    | i3300                 | B30 Monocolour        | 1500            | 1              |
| ▲              | B-499    | <b>F N A</b>       | 50.80              | 25.40               | -                  | -               | -                            | -                             | THT-137-499-1.5-SC | BBP12                 | R7950, R4300, R4900   | 1500            | 1              |
| ▲              | B-499    | <b>F N A</b>       | 50.80              | 25.40               | -                  | -               | -                            | -                             | B33-137-499        | i3300                 | B30 Monocolour        | 1100            | 1              |
| ▲              | B-423    | <b>F A H</b>       | 50.80              | 25.40               | -                  | -               | -                            | -                             | BM-20-423          | M610, M611, M710      | R6000HF               | 1000            | 1              |
| ▲              | B-427    | <b>F N</b>         | 50.80              | 25.40               | -                  | -               | -                            | -                             | THT-137-427-3-AW** | BBP12, i7100, i5100   | R4300, R7950          | 3000            | 1              |
| ▲              | B-499    | <b>F N A</b>       | 50.80              | 25.40               | -                  | -               | -                            | -                             | THT-137-499-3      | BBP12, i7100, i5100   | R4900                 | 3000            | 1              |
| ▲              | B-423    | <b>F A H</b>       | 76.20              | 25.40               | -                  | -               | -                            | -                             | M7-22-423          | M710                  | R6000HF               | 100             | 1              |
| ▲              | B-423    | <b>F A</b>         | 76.20              | 25.40               | -                  | -               | -                            | -                             | M6-22-423          | M610, M611            | R6000HF               | 100             | 1              |
| ▲              | B-490    | <b>F N H L</b>     | 95.25              | 38.10               | -                  | -               | -                            | -                             | THT-158-490-3      | BBP12, i7100, i5100   | R4300, R7950          | 3000            | 1              |
| ▲              | B-490    | <b>F N H L</b>     | 95.25              | 38.10               | -                  | -               | -                            | -                             | THT-158-490-1.5-SC | BBP12                 | R7950                 | 1500            | 1              |

\*\*AW = All White / no transparent area.



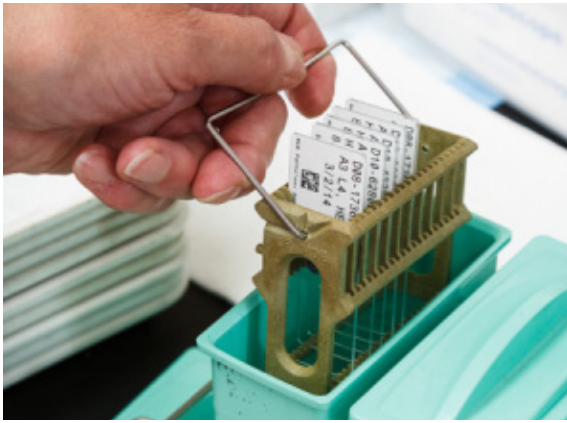

## Slide Labels

Brady offers labels specifically designed to identify slides and to resist exposure to harsh chemicals during the slide staining process. They perform well in the hematoxylin and eosin slide staining process and offer superior chemical resistance also useful in other laboratory contexts.

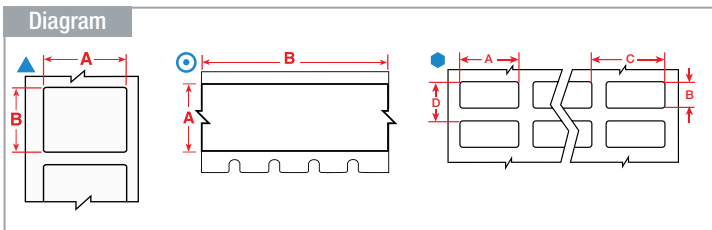

- F** Freezer environment
- N** Liquid nitrogen environment
- A** Autoclave environment
- H** Hot water bath (100°C)
- S** Self-laminating label
- L** Low-profile (extremely thin) label
- R** Removable

Labels are shown in order of label width.

The background colours in the Order Reference column represent the material colour.

See page 58 for Brady's range of label printers.

| Diagram | Material | Special Properties                  | Label Width A (mm) | Label Height B (mm) | Label Length B (m) | Order Reference    | Printer Compatibility | Printer Ribbon Series | Labels per Roll | Labels per Row |
|---------|----------|-------------------------------------|--------------------|---------------------|--------------------|--------------------|-----------------------|-----------------------|-----------------|----------------|
| ⊙       | B-488    | <b>F</b> <b>A</b>                   | 9.53               | –                   | 6.40               | M21-375-488        | M210-LAB, M211        | R4300                 | 1               | –              |
| ▲       | B-492    | <b>F</b> <b>N</b> <b>H</b> <b>L</b> | 12.70              | 41.91               | –                  | M6-124-492         | M610, M611            | R4300, R6400          | 500             | 1              |
| ⊙       | B-488    | <b>F</b> <b>A</b>                   | 12.70              | –                   | 6.40               | M21-500-488        | M210-LAB, M211        | R4300                 | 1               | –              |
| ⊗       | B-492    | <b>F</b> <b>H</b> <b>L</b>          | 15.24              | 41.28               | –                  | M6-205-492         | M610, M611            | R4300, R6400          | 250             | 1              |
| ▲       | B-488    | <b>F</b> <b>A</b>                   | 19.05              | 22.86               | –                  | M6-80-488          | M610, M611            | R4300                 | 250             | 1              |
| ▲       | B-488    | <b>F</b> <b>A</b>                   | 19.05              | 22.86               | –                  | M7-80-488          | M710                  | R4300                 | 250             | 1              |
| ⬢       | B-488    | <b>F</b> <b>A</b>                   | 19.05              | 22.86               | –                  | THT-140-488-3      | BBP12, i7100, i5100   | R4300, R7950          | 3000            | 2              |
| ⬢       | B-488    | <b>F</b> <b>A</b>                   | 19.05              | 22.86               | –                  | THT-140-488-1.5-SC | BBP12                 | R7950                 | 1500            | 2              |
| ⊙       | B-488    | <b>F</b> <b>A</b>                   | 19.05              | –                   | 6.40               | M21-750-488        | M210-LAB, M211        | R4300                 | 1               | –              |
| ▲       | B-492    | <b>F</b> <b>N</b> <b>H</b> <b>L</b> | 20.96              | 9.53                | –                  | M6-130-492         | M610, M611            | R4300, R6400          | 500             | 1              |
| ▲       | B-481    | <b>F</b> <b>H</b>                   | 22.86              | 9.53                | –                  | B33-195-481        | i3300                 | B30 Monocolour        | 3000            | 1              |
| ▲       | B-481    | <b>F</b> <b>H</b>                   | 22.86              | 9.53                | –                  | M-195-481          | BMP51                 | R6400                 | 320             | –              |
| ▲       | B-481    | <b>F</b> <b>H</b>                   | 22.86              | 9.53                | –                  | M6-195-481         | M610, M611            | R6400                 | 500             | 1              |
| ▲       | B-481    | <b>F</b> <b>H</b>                   | 22.86              | 9.53                | –                  | THT-195-481-3      | BBP12, i7100, i5100   | R6400                 | 3000            | 1              |
| ⬢       | B-488    | <b>F</b> <b>A</b>                   | 22.86              | 19.05               | –                  | B33-616-488        | i3300                 | B30-R4300             | 3000            | 3              |
| ▲       | B-481    | <b>F</b> <b>H</b>                   | 22.86              | 19.05               | –                  | B33-194-481        | i3300                 | B30 Monocolour        | 2000            | 1              |
| ⬢       | B-488    | <b>F</b> <b>A</b>                   | 22.86              | 19.05               | –                  | BPT-616-488        | BBP12                 | R7950                 | 3000            | 3              |
| ▲       | B-481    | <b>F</b> <b>H</b>                   | 22.86              | 19.05               | –                  | BPT-194-481        | BBP12                 | R6400                 | 2500            | 1              |
| ▲       | B-481    | <b>F</b> <b>H</b>                   | 22.86              | 19.05               | –                  | M-194-481          | BMP51                 | R6400                 | 320             | –              |
| ▲       | B-481    | <b>F</b> <b>H</b>                   | 22.86              | 19.05               | –                  | M6-194-481         | M610, M611            | R6400                 | 250             | 1              |
| ▲       | B-481    | <b>F</b> <b>H</b>                   | 22.86              | 19.05               | –                  | THT-194-481-3      | BBP12, i7100, i5100   | R6400                 | 3000            | 1              |
| ⬢       | B-488    | <b>F</b> <b>A</b>                   | 22.86              | 22.86               | –                  | B33-617-488        | i3300                 | B30-R4300             | 3000            | 3              |
| ⬢       | B-488    | <b>F</b> <b>A</b>                   | 22.86              | 22.86               | –                  | BPT-617-488        | BBP12                 | R7950                 | 3000            | 3              |
| ⬢       | B-481    | <b>F</b> <b>H</b>                   | 22.86              | 22.86               | –                  | BPT-207-481        | BBP12                 | R6400                 | 2500            | 4              |
| ▲       | B-481    | <b>F</b> <b>H</b>                   | 22.86              | 22.86               | –                  | BPT-164-481        | BBP12                 | R6400                 | 2500            | 1              |
| ▲       | B-488    | <b>F</b> <b>A</b>                   | 22.86              | 22.86               | –                  | M-97-488           | BMP51                 | R4300                 | 280             | –              |
| ▲       | B-481    | <b>F</b> <b>H</b>                   | 22.86              | 22.86               | –                  | M-97-481           | BMP51                 | R6400                 | 280             | –              |
| ▲       | B-488    | <b>F</b> <b>A</b>                   | 22.86              | 22.86               | –                  | M6-97-488          | M610, M611            | R4300                 | 250             | 1              |
| ▲       | B-481    | <b>F</b> <b>H</b>                   | 22.86              | 22.86               | –                  | M6-97-481          | M610, M611            | R6400                 | 250             | 1              |
| ▲       | B-488    | <b>F</b> <b>A</b>                   | 22.86              | 22.86               | –                  | M7-97-488          | M710                  | R4300                 | 250             | 1              |
| ▲       | B-481    | <b>F</b> <b>H</b>                   | 22.86              | 22.86               | –                  | M7-97-481          | M710                  | R6400                 | 250             | 1              |
| ▲       | B-488    | <b>F</b> <b>A</b>                   | 22.86              | 22.86               | –                  | THT-164-488-1      | BBP12, i7100, i5100   | R4300, R7950          | 1000            | 1              |
| ▲       | B-481    | <b>F</b> <b>H</b>                   | 22.86              | 22.86               | –                  | THT-164-481-3      | BBP12, i7100, i5100   | R6400                 | 3000            | 1              |
| ⬢       | B-488    | <b>F</b> <b>A</b>                   | 22.86              | 22.86               | –                  | THT-141-488-3      | BBP12, i7100, i5100   | R4300, R7950          | 3000            | 2              |

>>

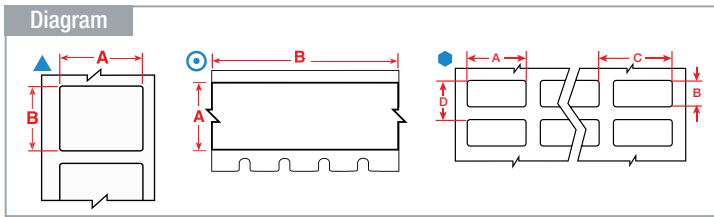

Labels are shown in order of label width.

The background colours in the Order Reference column represent the material colour.

See page 58 for Brady's range of label printers.

| Diagram | Material | Special Properties                  | Label Width A (mm) | Label Height B (mm) | Label Length B (m) | Order Reference    | Printer Compatibility | Printer Ribbon Series | Labels per Roll | Labels per Row |
|---------|----------|-------------------------------------|--------------------|---------------------|--------------------|--------------------|-----------------------|-----------------------|-----------------|----------------|
| ●       | B-481    | <b>F</b> <b>H</b>                   | 22.86              | 22.86               | –                  | THT-141-481-3      | BBP12, i7100, i5100   | R6400                 | 3000            | 2              |
| ●       | B-481    | <b>F</b> <b>H</b>                   | 22.86              | 22.86               | –                  | THT-141-481-1.5-SC | BBP12                 | R6400                 | 1500            | 2              |
| ▲       | B-492    | <b>F</b> <b>N</b> <b>H</b> <b>L</b> | 22.86              | 25.40               | –                  | M6-156-492         | M610, M611            | R4300, R6400          | 250             | 1              |
| ▲       | B-494    | <b>F</b> <b>N</b> <b>H</b>          | 25.40              | 12.70               | –                  | M6-17-494-BL       | M611, M610            | R6400                 | 500             | 1              |
| ▲       | B-494    | <b>F</b> <b>N</b> <b>H</b>          | 25.40              | 12.70               | –                  | M6-17-494-GN       | M611, M610            | R6400                 | 500             | 1              |
| ▲       | B-494    | <b>F</b> <b>N</b> <b>H</b>          | 25.40              | 12.70               | –                  | M6-17-494-OR       | M611, M610            | R6400                 | 500             | 1              |
| ▲       | B-494    | <b>F</b> <b>N</b> <b>H</b>          | 25.40              | 12.70               | –                  | M6-17-494-PK       | M611, M610            | R6400                 | 500             | 1              |
| ▲       | B-494    | <b>F</b> <b>N</b> <b>H</b>          | 25.40              | 12.70               | –                  | M6-17-494-RD       | M611, M610            | R6400                 | 500             | 1              |
| ▲       | B-494    | <b>F</b> <b>N</b> <b>H</b>          | 25.40              | 12.70               | –                  | M6-17-494-YL       | M611, M610            | R6400                 | 500             | 1              |
| ▲       | B-492    | <b>F</b> <b>N</b> <b>H</b> <b>L</b> | 25.40              | 12.70               | –                  | M6-17-492          | M610, M611            | R4300, R6400          | 250             | 1              |
| ▲       | B-494    | <b>F</b> <b>N</b> <b>H</b>          | 25.40              | 25.40               | –                  | M6-19-494-BL       | M611, M610            | R6400                 | 250             | 1              |
| ▲       | B-494    | <b>F</b> <b>N</b> <b>H</b>          | 25.40              | 25.40               | –                  | M6-19-494-GN       | M611, M610            | R6400                 | 250             | 1              |
| ▲       | B-494    | <b>F</b> <b>N</b> <b>H</b>          | 25.40              | 25.40               | –                  | M6-19-494-OR       | M611, M610            | R6400                 | 250             | 1              |
| ▲       | B-494    | <b>F</b> <b>N</b> <b>H</b>          | 25.40              | 25.40               | –                  | M6-19-494-PK       | M611, M610            | R6400                 | 250             | 1              |
| ▲       | B-494    | <b>F</b> <b>N</b> <b>H</b>          | 25.40              | 25.40               | –                  | M6-19-494-RD       | M611, M610            | R6400                 | 250             | 1              |
| ▲       | B-494    | <b>F</b> <b>N</b> <b>H</b>          | 25.40              | 25.40               | –                  | M6-19-494-YL       | M611, M610            | R6400                 | 250             | 1              |
| ▲       | B-492    | <b>F</b> <b>N</b> <b>H</b> <b>L</b> | 25.40              | 25.40               | –                  | M6-19-492          | M610, M611            | R4300, R6400          | 250             | 1              |
| ▲       | B-492    | <b>F</b> <b>N</b> <b>H</b> <b>L</b> | 25.40              | 44.45               | –                  | M6-203-492         | M610, M611            | R4300, R6400          | 250             | 1              |
| ▲       | B-492    | <b>F</b> <b>N</b> <b>H</b> <b>L</b> | 25.40              | 48.26               | –                  | M6-204-492         | M610, M611            | R4300, R6400          | 250             | 1              |
| ▲       | B-488    | <b>F</b> <b>A</b>                   | 48.26              | 6.35                | –                  | B33-635-488        | i3300                 | B30-R4300             | 2000            | 1              |
| ▲       | B-488    | <b>F</b> <b>A</b>                   | 48.26              | 6.35                | –                  | M-81-488           | BMP41, BMP51          | R4300                 | 160             | –              |
| ▲       | B-488    | <b>F</b> <b>A</b>                   | 50.80              | 6.35                | –                  | THT-15-488-2.5     | BBP12, i7100, i5100   | R4300, R7950          | 2500            | 1              |
| ▲       | B-481    | <b>F</b> <b>H</b>                   | 63.50              | 5.08                | –                  | THT-142-481-2.5    | BBP12, i7100, i5100   | R6400                 | 2500            | 1              |
| ▲       | B-481    | <b>F</b> <b>H</b>                   | 63.50              | 5.08                | –                  | THT-142-481-2.5-SC | BBP12                 | R6400                 | 2500            | 1              |

**F** Freezer environment **N** Liquid nitrogen environment **A** Autoclave environment **H** Hot water bath (100°C) **S** Self-laminating label **L** Low-profile (extremely thin) label **R** Removable



# B-498 Re-Identify Tissue Cassettes Labels



## B-498 Re-Identify Tissue Cassettes Labels

Tissue cassettes are often re-identified when labs collect samples from various biorepositories. Typically, each laboratory has its own unique way of identifying samples, which creates a need to re-identify samples in a common way.

Brady B-498 post-process labels offer customers the optimal way to organise these specimens and conduct further studies. These labels can be applied directly onto the cassettes, on pure paraffin wax and on top of another label or identifier.

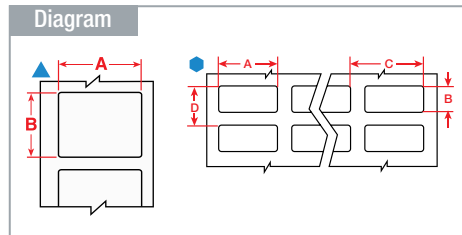

- F** Freezer environment
- A** Autoclave environment
- H** Hot water bath (100°C)
- S** Self-laminating label
- L** Low-profile (extremely thin) label
- R** Removable

Labels are shown in order of label width.

The background colours in the Order Reference column represent the material colour.

See page 58 for Brady's range of label printers.

| Diagram | Material | Special Properties | Label Width A (mm) | Label Height B (mm) | Order Reference    | Printer Compatibility | Printer Ribbon Series | Labels per Roll | Labels per Row |
|---------|----------|--------------------|--------------------|---------------------|--------------------|-----------------------|-----------------------|-----------------|----------------|
| ▲       | B-498    | <b>F</b> <b>R</b>  | 6.35               | 19.05               | M7-10-498          | M710                  | R6200                 | 750             | 1              |
| ●       | B-498    | <b>F</b> <b>R</b>  | 19.05              | 6.35                | B33-1-498          | i3300                 | B30 Monocolour        | 5000            | 4              |
| ▲       | B-498    | <b>F</b> <b>R</b>  | 19.05              | 6.35                | THT-252-498-3      | BBP12, i7100, i5100   | R4300, R7950          | 3000            | 1              |
| ▲       | B-498    | <b>F</b> <b>R</b>  | 19.05              | 6.35                | THT-252-498-3-SC   | BBP12                 | R7950                 | 3000            | 1              |
| ●       | B-498    | <b>F</b> <b>R</b>  | 19.05              | 6.35                | THT-1-498-10       | BBP12, i7100, i5100   | R4300, R7950          | 10000           | 4              |
| ▲       | B-498    | <b>F</b> <b>R</b>  | 19.05              | 12.70               | M-11-498           | BMP41, BMP51          | R6200                 | 220             | –              |
| ▲       | B-498    | <b>F</b> <b>R</b>  | 19.05              | 19.05               | B33-254-498        | i3300, i5300          | B30 Monocolour        | 1000            | 1              |
| ▲       | B-498    | <b>F</b> <b>R</b>  | 19.05              | 19.05               | THT-254-498-3      | BBP12, i7100, i5100   | R4300, R7950          | 3000            | 1              |
| ▲       | B-498    | <b>F</b> <b>R</b>  | 19.05              | 19.05               | THT-254-498-1.5-SC | BBP12                 | R7950                 | 1500            | 1              |
| ▲       | B-498    | <b>F</b> <b>R</b>  | 25.40              | 4.78                | THT-253-498-3      | BBP12, i7100, i5100   | R4300, R7950          | 3000            | 1              |
| ▲       | B-498    | <b>F</b> <b>R</b>  | 25.40              | 4.78                | THT-253-498-3-SC   | BBP12                 | R7950                 | 3000            | 1              |

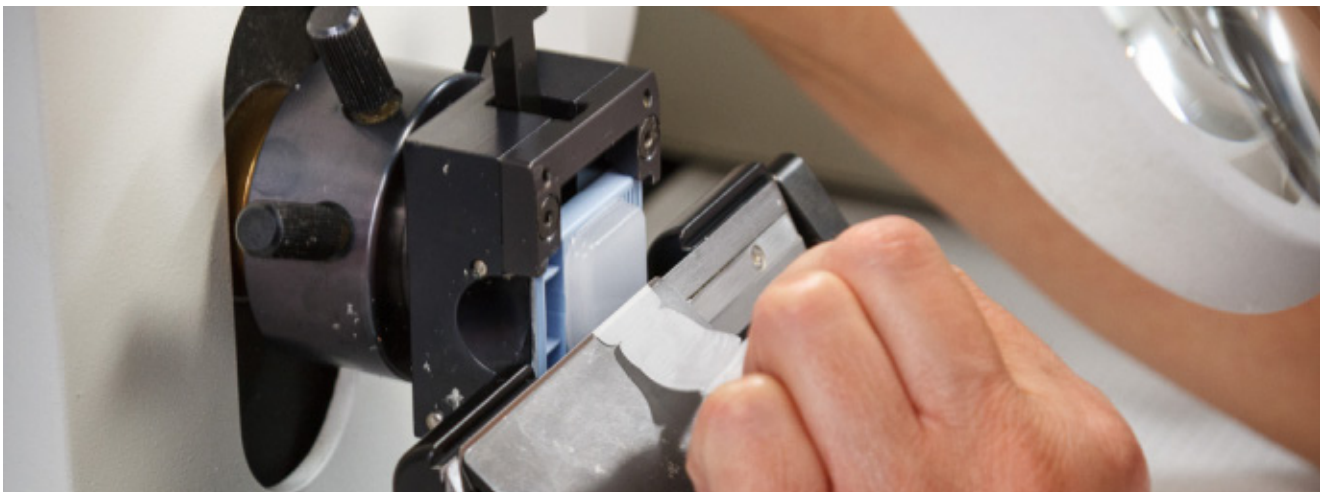



## Straw and Rod Labels

Brady offers a range of labels designed to fit the small surface area of straws and rods and will withstand long-term storage.

- F** Freezer environment
- N** Liquid nitrogen environment
- A** Autoclave environment
- H** Hot water bath (100°C)
- S** Self-laminating label
- L** Low-profile (extremely thin) label
- R** Removable

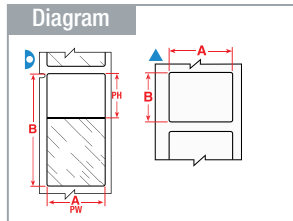

The background colours in the Order Reference column represent the material colour.

See page 58 for Brady's range of label printers.

Labels are shown per straw size and in order of label width.

| Diagram          | Material | Special Properties | Label Width A (mm) | Label Height B (mm) | Printable Area Width PW (mm) | Printable Area Height PH (mm) | Order Reference  | Printer Compatibility | Printer Ribbon Series | Labels per Roll | Labels per Row |
|------------------|----------|--------------------|--------------------|---------------------|------------------------------|-------------------------------|------------------|-----------------------|-----------------------|-----------------|----------------|
| <b>0.25 ml</b>   |          |                    |                    |                     |                              |                               |                  |                       |                       |                 |                |
| ▲                | B-427    | <b>FN S</b>        | 20.00              | 20.00               | -                            | -                             | BPTLAB-35-427-YL | BBP12                 | R7950                 | 1000            | 1              |
| ▷                | B-427    | <b>FN S</b>        | 25.40              | 25.40               | 25.40                        | 9.53                          | B33-116-427      | i3300                 | B30 Monocolour        | 2500            | 2              |
| ▷                | B-427    | <b>FN S</b>        | 25.40              | 25.40               | 25.40                        | 9.53                          | BM-19-427        | M610, M611, M710      | R4300                 | 2500            | 1              |
| ▷                | B-427    | <b>FN S</b>        | 25.40              | 25.40               | 25.40                        | 9.53                          | M-49-427         | BMP41, BMP51          | R4300                 | 260             | -              |
| ▷                | B-427    | <b>FN S</b>        | 25.40              | 25.40               | 25.40                        | 9.53                          | M6-19-427        | M610, M611            | R4300, R6200, R4400   | 250             | 1              |
| ▷                | B-427    | <b>FN S</b>        | 25.40              | 25.40               | 25.40                        | 9.53                          | M6-19-427-BL     | M610, M611            | R4300                 | 250             | 1              |
| ▷                | B-427    | <b>FN S</b>        | 25.40              | 25.40               | 25.40                        | 9.53                          | M6-19-427-BR     | M610, M611            | R4300                 | 250             | 1              |
| ▷                | B-427    | <b>FN S</b>        | 25.40              | 25.40               | 25.40                        | 9.53                          | M6-19-427-GR     | M610, M611            | R4300                 | 250             | 1              |
| ▷                | B-427    | <b>FN S</b>        | 25.40              | 25.40               | 25.40                        | 9.53                          | M6-19-427-GY     | M610, M611            | R4300                 | 250             | 1              |
| ▷                | B-427    | <b>FN S</b>        | 25.40              | 25.40               | 25.40                        | 9.53                          | M6-19-427-OR     | M610, M611            | R4300                 | 250             | 1              |
| ▷                | B-427    | <b>FN S</b>        | 25.40              | 25.40               | 25.40                        | 9.53                          | M6-19-427-PL     | M610, M611            | R4300                 | 250             | 1              |
| ▷                | B-427    | <b>FN S</b>        | 25.40              | 25.40               | 25.40                        | 9.53                          | M6-19-427-RD     | M610, M611            | R4300                 | 250             | 1              |
| ▷                | B-427    | <b>FN S</b>        | 25.40              | 25.40               | 25.40                        | 9.53                          | M6-19-427-YL     | M610, M611            | R4300                 | 250             | 1              |
| ▷                | B-461    | <b>FNAHSL</b>      | 25.40              | 25.40               | 25.40                        | 9.53                          | M7-19-461        | M710                  | R4300                 | 250             | 1              |
| ▷                | B-427    | <b>FN S</b>        | 25.40              | 25.40               | 25.40                        | 9.53                          | M7-19-427        | M710                  | R4300                 | 250             | 1              |
| ▷                | B-427    | <b>FN S</b>        | 25.40              | 25.40               | 25.40                        | 9.53                          | M7-19-427-YL     | M710                  | R4300, R4400, R6700   | 250             | 1              |
| ▷                | B-427    | <b>FN S</b>        | 25.40              | 25.40               | 25.40                        | 9.53                          | THT-116-427-5    | BBP12, i7100, i5100   | R4300, R7950          | 5000            | 2              |
| ▷                | B-427    | <b>FN S</b>        | 25.40              | 25.40               | 25.40                        | 9.65                          | B33-211-427      | i3300                 | B30-R4300             | 3000            | 3              |
| ▷                | B-427    | <b>FN S</b>        | 25.40              | 25.40               | 25.40                        | 9.65                          | BPT-211-427      | BBP12                 | R7950                 | 3000            | 3              |
| ▷                | B-427    | <b>FN S</b>        | 44.45              | 25.40               | 38.10                        | 9.53                          | M-133-427        | BMP51                 | R4300                 | 140             | -              |
| ▷                | B-427    | <b>FN S</b>        | 44.45              | 25.40               | 44.45                        | 9.53                          | B33-120-427      | i3300                 | B30 Monocolour        | 1250            | 1              |
| ▷                | B-427    | <b>FN S</b>        | 44.45              | 38.10               | 44.45                        | 12.70                         | B33-121-427      | i3300                 | B30 Monocolour        | 1000            | 1              |
| ▷                | B-427    | <b>FN S</b>        | 44.45              | 38.10               | 44.45                        | 12.70                         | M7-88-427        | M710                  | R4300                 | 250             | 1              |
| <b>0.5 ml</b>    |          |                    |                    |                     |                              |                               |                  |                       |                       |                 |                |
| ▷                | B-427    | <b>FN S</b>        | 25.40              | 63.50               | 25.40                        | 19.05                         | M-51-427         | BMP41, BMP51          | R4300                 | 110             | -              |
| ▷                | B-427    | <b>FN S</b>        | 25.40              | 63.50               | 25.40                        | 19.05                         | B33-511-427      | i3300                 | B30-R4300             | 1500            | 3              |
| ▷                | B-427    | <b>FN S</b>        | 25.40              | 63.50               | 25.40                        | 19.05                         | BM-21-427        | M610, M611, M710      | R4300                 | 1000            | 1              |
| ▷                | B-427    | <b>FN S</b>        | 25.40              | 63.50               | 25.40                        | 19.05                         | BPT-511-427      | BBP12                 | R7950                 | 3000            | 3              |
| ▷                | B-427    | <b>FN S</b>        | 25.40              | 63.50               | 25.40                        | 19.05                         | M6-21-427        | M611, M610, M710      | R4300, R6200, R4400   | 100             | 1              |
| ▷                | B-427    | <b>FN S</b>        | 25.40              | 63.50               | 25.40                        | 19.05                         | M6-21-427-BL     | M610, M611            | R4300                 | 100             | 1              |
| ▷                | B-427    | <b>FN S</b>        | 25.40              | 63.50               | 25.40                        | 19.05                         | M6-21-427-BR     | M610, M611            | R4300                 | 100             | 1              |
| ▷                | B-427    | <b>FN S</b>        | 25.40              | 63.50               | 25.40                        | 19.05                         | M6-21-427-GR     | M610, M611            | R4300                 | 100             | 1              |
| ▷                | B-427    | <b>FN S</b>        | 25.40              | 63.50               | 25.40                        | 19.05                         | M6-21-427-GY     | M610, M611            | R4300                 | 100             | 1              |
| ▷                | B-427    | <b>FN S</b>        | 25.40              | 63.50               | 25.40                        | 19.05                         | M6-21-427-OR     | M610, M611            | R4300                 | 100             | 1              |
| ▷                | B-427    | <b>FN S</b>        | 25.40              | 63.50               | 25.40                        | 19.05                         | M6-21-427-PL     | M610, M611            | R4300                 | 100             | 1              |
| ▷                | B-427    | <b>FN S</b>        | 25.40              | 63.50               | 25.40                        | 19.05                         | M6-21-427-RD     | M610, M611            | R4300                 | 100             | 1              |
| ▷                | B-427    | <b>FN S</b>        | 25.40              | 63.50               | 25.40                        | 19.05                         | M6-21-427-YL     | M610, M611            | R4300                 | 100             | 1              |
| ▷                | B-427    | <b>FN S</b>        | 25.40              | 63.50               | 25.40                        | 19.05                         | M7-21-427        | M710                  | R4300                 | 100             | 1              |
| ▷                | B-427    | <b>FN S</b>        | 25.40              | 63.50               | 25.40                        | 19.05                         | M7-21-427-YL     | M710                  | R4300, R4400, R6700   | 100             | 1              |
| ▷                | B-427    | <b>FN S</b>        | 44.45              | 38.10               | 44.45                        | 12.70                         | M-134-427        | BMP51                 | R4300                 | 140             | -              |
| <b>Straw Rod</b> |          |                    |                    |                     |                              |                               |                  |                       |                       |                 |                |
| ▲                | B-427    | <b>FN</b>          | 6.35               | 27.94               | -                            | -                             | M-135-427-AW**   | BMP41, BMP51          | R4300                 | 240             | -              |
| ▲                | B-427    | <b>FN</b>          | 27.94              | 6.35                | -                            | -                             | M6-105-427-AW**  | M610, M611            | R4300                 | 750             | 1              |

\*Label is rotated 90° on liner. \*\*AW = All White / no transparent area.

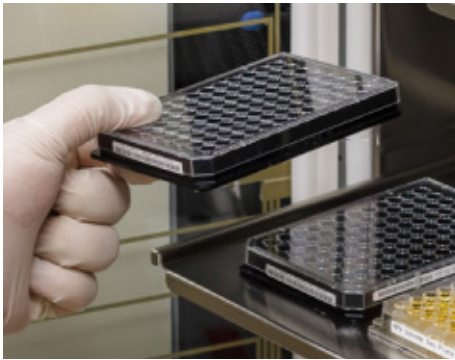

## Well Plate Labels

When total tracking of all sample collections is required then Brady has a solution for Well plate identification. Our well plate labels guarantee crystal clear text and barcoding for most lab environments.

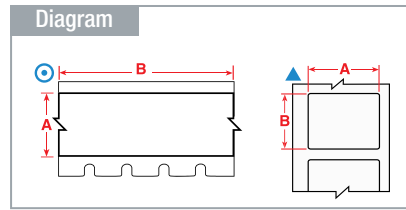

- F** Freezer environment
- N** Liquid nitrogen environment
- A** Autoclave environment
- H** Hot water bath (100°C)
- S** Self-laminating label
- L** Low-profile (extremely thin) label
- R** Removable

Labels are shown in order of label width.

The background colours in the Order Reference column represent the material colour.

See page 58 for Brady's range of label printers.

| Diagram | Material | Special Properties | Label Width A (mm) | Label Height B (mm) | Label Length B (m) | Order Reference   | Printer Compatibility | Printer Ribbon Series | Labels per Roll | Labels per Row |   |
|---------|----------|--------------------|--------------------|---------------------|--------------------|-------------------|-----------------------|-----------------------|-----------------|----------------|---|
| ▲       | B-7425   | <b>F N A H</b>     | 6.35               | 50.80               | –                  | M6-2-7425         | M610, M611            | R4300, R6200, R6400   | 100             | 1              |   |
| ○       | B-595    | <b>F</b>           | 6.35               | –                   | 6.40               | M21-250-595-WT    | M210, M210-LAB, M211  | R6000HF               | 1               | –              |   |
| ○       | B-595    | <b>F</b>           | 6.35               | –                   | 6.40               | M21-250-595-YL    | M210, M210-LAB, M211  | R6000HF               | 1               | –              |   |
| ○       | B-430    | <b>F A H</b>       | 6.35               | –                   | 6.40               | M21-250-430-WT-CL | M210, M210-LAB, M211  | R6200                 | 1               | –              |   |
| ○       | B-423    | <b>F A H</b>       | 6.35               | –                   | 6.40               | M21-250-423       | M210, M210-LAB, M211  | R6200                 | 1               | –              |   |
| ○       | B-430    | <b>F A H</b>       | 6.35               | –                   | 6.40               | M21-250-430       | M210, M210-LAB, M211  | R6200                 | 1               | –              |   |
| ○       | B-499    | <b>F N A</b>       | 9.53               | –                   | 4.88               | M21-375-499       | M210, M210-LAB, M211  | R4300                 | 1               | –              |   |
| ○       | B-499    | <b>F N A</b>       | 9.53               | –                   | 4.88               | MC-375-499        | BMP41, BMP51          | R4300                 | 1               | –              |   |
| ○       | B-423    | <b>F A H</b>       | 9.53               | –                   | 6.40               | M21-375-423       | M210, M210-LAB, M211  | R6200                 | 1               | –              |   |
| ○       | B-430    | <b>F A H</b>       | 9.53               | –                   | 6.40               | M21-375-430       | M210, M210-LAB, M211  | R6200                 | 1               | –              |   |
| ○       | B-488    | <b>F A</b>         | 9.53               | –                   | 6.40               | M21-375-488       | M210, M210-LAB, M211  | R4300                 | 1               | –              |   |
| ○       | B-7425   | <b>F N A H</b>     | 9.53               | –                   | 6.40               | M21-375-7425      | M210, M210-LAB, M211  | R4300                 | 1               | –              |   |
| ○       | B-595    | <b>F</b>           | 9.53               | –                   | 6.40               | M21-375-595-PL    | M210, M210-LAB, M211  | R4400                 | 1               | –              |   |
| ○       | B-595    | <b>F</b>           | 9.53               | –                   | 6.40               | M21-375-595-BR    | M210, M210-LAB, M211  | R4400                 | 1               | –              |   |
| ○       | B-595    | <b>F</b>           | 9.53               | –                   | 6.40               | M21-375-595-GY    | M210, M210-LAB, M211  | R6000HF               | 1               | –              |   |
| ○       | B-595    | <b>F</b>           | 9.53               | –                   | 6.40               | M21-375-595-BK    | M210, M210-LAB, M211  | R4400                 | 1               | –              |   |
| ○       | B-430    | <b>F A H</b>       | 9.53               | –                   | 6.40               | M21-375-430-WT-CL | M210, M210-LAB, M211  | R6200                 | 1               | –              |   |
| ○       | B-595    | <b>F</b>           | 9.53               | –                   | 6.40               | M21-375-595-WT    | M210, M210-LAB, M211  | R6000HF               | 1               | –              |   |
| ○       | B-595    | <b>F</b>           | 9.53               | –                   | 6.40               | M21-375-595-GN    | M210, M210-LAB, M211  | R4400                 | 1               | –              |   |
| ○       | B-595    | <b>F</b>           | 9.53               | –                   | 6.40               | M21-375-595-YL    | M210, M210-LAB, M211  | R6000HF               | 1               | –              |   |
| ○       | B-595    | <b>F</b>           | 9.53               | –                   | 6.40               | M21-375-595-BL    | M210, M210-LAB, M211  | R4400                 | 1               | –              |   |
| ○       | B-595    | <b>F</b>           | 9.53               | –                   | 6.40               | M21-375-595-OR    | M210, M210-LAB, M211  | R6000HF               | 1               | –              |   |
| ○       | B-595    | <b>F</b>           | 9.53               | –                   | 6.40               | M21-375-595-RD    | M210, M210-LAB, M211  | R4400                 | 1               | –              |   |
| ○       | B-595    | <b>F</b>           | 9.53               | –                   | 7.62               | MC-375-595-WT-BK  | BMP41, BMP51          | R6000HF               | 1               | –              |   |
| ○       | B-595    | <b>F</b>           | 9.53               | –                   | 7.62               | MC-375-595-YL-BK  | BMP41, BMP51          | R6000HF               | 1               | –              |   |
| ○       | B-595    | <b>F</b>           | 9.53               | –                   | 7.62               | MC-375-595-RD-WT  | BMP41, BMP51          | R4400                 | 1               | –              |   |
| ○       | B-430    | <b>F A H</b>       | 9.53               | –                   | 15.24              | M7C-375-430       | M710                  | R6000HF               | 1               | 1              |   |
| ▲       | B-423    | <b>F A H</b>       | 12.70              | 12.70               | –                  | M7-7-423          | M710                  | R6000HF               | 500             | 1              |   |
| ▲       | B-423    | <b>F A</b>         | 12.70              | 12.70               | –                  | M6-7-423          | M610, M611            | R6000HF               | 500             | 1              |   |
| ▲       | B-423    | <b>F A H</b>       | 12.70              | 12.70               | –                  | BM-7-423          | M610, M611, M710      | R6000HF               | 5000            | 1              |   |
| ▲       | B-499    | <b>F N A</b>       | 12.70              | 38.10               | –                  | M7-29-499         | M710                  | R6200                 | 500             | 1              |   |
| ▲       | B-499    | <b>F N A</b>       | 12.70              | 38.10               | –                  | M6-29-499         | M610, M611            | R4300, R6000HF, R6200 | 500             | 1              |   |
| ▲       | B-498    | <b>F</b>           | <b>R</b>           | 12.70               | 38.10              | –                 | BM-29-498             | M610, M611, M710      | R6200           | 5000           | 1 |
| ○       | B-499    | <b>F N A</b>       | 12.70              | –                   | 4.88               | M21-500-499       | M210, M210-LAB, M211  | R4300                 | 1               | –              |   |
| ○       | B-499    | <b>F N A</b>       | 12.70              | –                   | 4.88               | MC-500-499        | BMP41, BMP51          | R4300                 | 1               | –              |   |
| ○       | B-595    | <b>F</b>           | 12.70              | –                   | 6.10               | MC-500-595-CL-BK  | BMP41, BMP51          | R6000HF               | 1               | –              |   |
| ○       | B-595    | <b>F</b>           | 12.70              | –                   | 6.10               | MC-500-595-CL-WT  | BMP41, BMP51          | R4400                 | 1               | –              |   |
| ○       | B-423    | <b>F A H</b>       | 12.70              | –                   | 6.40               | M21-500-423       | M210, M210-LAB, M211  | R6200                 | 1               | –              |   |
| ○       | B-430    | <b>F A H</b>       | 12.70              | –                   | 6.40               | M21-500-430       | M210, M210-LAB, M211  | R6200                 | 1               | –              |   |
| ○       | B-488    | <b>F A</b>         | 12.70              | –                   | 6.40               | M21-500-488       | M210, M210-LAB, M211  | R4300                 | 1               | –              |   |
| ○       | B-7425   | <b>F N A H</b>     | 12.70              | –                   | 6.40               | M21-500-7425      | M210, M210-LAB, M211  | R4300                 | 1               | –              |   |
| ○       | B-595    | <b>F</b>           | 12.70              | –                   | 6.40               | M21-500-595-PL    | M210, M210-LAB, M211  | R4400                 | 1               | –              |   |
| ○       | B-595    | <b>F</b>           | 12.70              | –                   | 6.40               | M21-500-595-BR    | M210, M210-LAB, M211  | R4400                 | 1               | –              |   |
| ○       | B-595    | <b>F</b>           | 12.70              | –                   | 6.40               | M21-500-595-GY    | M210, M210-LAB, M211  | R6000HF               | 1               | –              |   |
| ○       | B-595    | <b>F</b>           | 12.70              | –                   | 6.40               | M21-500-595-BK    | M210, M210-LAB, M211  | R4400                 | 1               | –              |   |
| ○       | B-430    | <b>F A H</b>       | 12.70              | –                   | 6.40               | M21-500-430-WT-CL | M210, M210-LAB, M211  | R6200                 | 1               | –              |   |
| ○       | B-595    | <b>F</b>           | 12.70              | –                   | 6.40               | M21-500-595-RD    | M210, M210-LAB, M211  | R4400                 | 1               | –              |   |
| ○       | B-595    | <b>F</b>           | 12.70              | –                   | 6.40               | M21-500-595-OR    | M210, M210-LAB, M211  | R6000HF               | 1               | –              |   |
| ○       | B-595    | <b>F</b>           | 12.70              | –                   | 6.40               | M21-500-595-BL    | M210, M210-LAB, M211  | R4400                 | 1               | –              |   |
| ○       | B-595    | <b>F</b>           | 12.70              | –                   | 6.40               | M21-500-595-YL    | M210, M210-LAB, M211  | R6000HF               | 1               | –              |   |
| ○       | B-595    | <b>F</b>           | 12.70              | –                   | 6.40               | M21-500-595-GN    | M210, M210-LAB, M211  | R4400                 | 1               | –              |   |
| ○       | B-595    | <b>F</b>           | 12.70              | –                   | 6.40               | M21-500-595-WT    | M210, M210-LAB, M211  | R6000HF               | 1               | –              |   |
| ○       | B-595    | <b>F</b>           | 12.70              | –                   | 7.62               | MC-500-595-OR-BK  | BMP41, BMP51          | R6000HF               | 1               | –              |   |
| ○       | B-595    | <b>F</b>           | 12.70              | –                   | 7.62               | MC-500-595-WT-BK  | BMP41, BMP51          | R6000HF               | 1               | –              |   |

>>

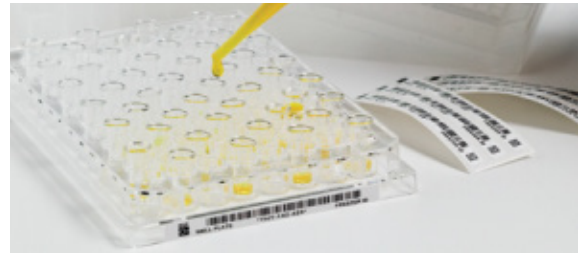
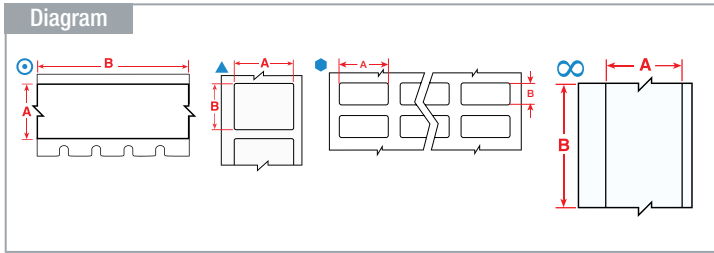

Labels are shown in order of label width.

The background colours in the Order Reference column represent the material colour.

See page 58 for Brady's range of label printers.

| Diagram | Material | Special Properties | Label Width A (mm) | Label Height B (mm) | Label Length B (m) | Order Reference   | Printer Compatibility | Printer Ribbon Series | Labels per Roll | Labels per Row |
|---------|----------|--------------------|--------------------|---------------------|--------------------|-------------------|-----------------------|-----------------------|-----------------|----------------|
| ⊙       | B-595    | F                  | 12.70              | –                   | 7.62               | MC-500-595-YL-BK  | BMP41, BMP51          | R6000HF               | 1               | –              |
| ⊙       | B-595    | F                  | 12.70              | –                   | 7.62               | MC-500-595-WT-RD  | BMP41, BMP51          | R4400                 | 1               | –              |
| ⊙       | B-595    | F                  | 12.70              | –                   | 7.62               | MC-500-595-BK-WT  | BMP41, BMP51          | R4400                 | 1               | –              |
| ⊙       | B-595    | F                  | 12.70              | –                   | 7.62               | MC-500-595-BL-WT  | BMP41, BMP51          | R4400                 | 1               | –              |
| ⊙       | B-595    | F                  | 12.70              | –                   | 7.62               | MC-500-595-GN-WT  | BMP41, BMP51          | R4400                 | 1               | –              |
| ⊙       | B-595    | F                  | 12.70              | –                   | 7.62               | MC-500-595-RD-WT  | BMP41, BMP51          | R4400                 | 1               | –              |
| ⊙       | B-499    | F N A              | 12.70              | –                   | 9.14               | M7C-500-499       | M710                  | R4300, R6000HF, R6200 | 1               | 1              |
| ⊙       | B-595    | F                  | 12.70              | –                   | 15.24              | M7C-500-595-YL    | M710                  | R6000HF, R4400-WT     | 1               | 1              |
| ⊙       | B-595    | F                  | 12.70              | –                   | 15.24              | M7C-500-595-WT    | M710                  | R6000HF               | 1               | 1              |
| ⊙       | B-595    | F                  | 12.70              | –                   | 15.24              | M7C-500-595-RD    | M710                  | R6000HF, R4400-WT     | 1               | 1              |
| ⊙       | B-595    | F                  | 12.70              | –                   | 15.24              | M7C-500-595-OR    | M710                  | R6000HF, R4400-WT     | 1               | 1              |
| ⊙       | B-595    | F                  | 12.70              | –                   | 15.24              | M7C-500-595-GN    | M710                  | R6000HF, R4400-WT     | 1               | 1              |
| ⊙       | B-595    | F                  | 12.70              | –                   | 15.24              | M7C-500-595-CL    | M710                  | R6000HF, R4400-WT     | 1               | 1              |
| ⊙       | B-595    | F                  | 12.70              | –                   | 15.24              | M7C-500-595-BL    | M710                  | R6000HF, R4400-WT     | 1               | 1              |
| ⊙       | B-595    | F                  | 12.70              | –                   | 15.24              | M7C-500-595-BK    | M710                  | R4400-WT              | 1               | 1              |
| ⊙       | B-430    | F A H              | 12.70              | –                   | 15.24              | M7C-500-430       | M710                  | R6000HF               | 1               | 1              |
| ⊙       | B-430    | F A H              | 12.70              | –                   | 15.24              | M6C-500-430       | M610, M611            | R6000HF               | 1               | 1              |
| ∞       | B-595    | F                  | 12.70              | –                   | 30.48              | B30C-500-595-BK   | i3300                 | B30-R10000-WT         | 1               | 1              |
| ∞       | B-595    | F                  | 12.70              | –                   | 30.48              | B30C-500-595-BL   | i3300                 | B30-R10000-WT         | 1               | 1              |
| ∞       | B-595    | F                  | 12.70              | –                   | 30.48              | B30C-500-595-CL   | i3300                 | B30-R10000            | 1               | 1              |
| ∞       | B-595    | F                  | 12.70              | –                   | 30.48              | B30C-500-595-GN   | i3300                 | B30-R10000-WT         | 1               | 1              |
| ∞       | B-595    | F                  | 12.70              | –                   | 30.48              | B30C-500-595-OR   | i3300                 | B30-R10000            | 1               | 1              |
| ∞       | B-595    | F                  | 12.70              | –                   | 30.48              | B30C-500-595-RD   | i3300                 | B30-R10000-WT         | 1               | 1              |
| ∞       | B-595    | F                  | 12.70              | –                   | 30.48              | B30C-500-595-WT   | i3300                 | B30-R10000            | 1               | 1              |
| ⊙       | B-595    | F                  | 12.70              | –                   | 30.48              | B30C-500-595-YL   | i3300                 | B30-R10000            | 1               | 1              |
| ⬢       | B-499    | F N A              | 19.05              | 6.35                | –                  | B33-1-499         | i3300, i5300          | B30 Monocolour        | 10000           | 4              |
| ⬢       | B-8423   | F A                | 19.05              | 6.35                | –                  | BPT-1-8423-2.5    | BBP12                 | R6000HF               | 2500            | 5              |
| ▲       | B-499    | F N A              | 19.05              | 12.70               | –                  | M21-11-499        | M210, M210-LAB, M211  | R4300                 | 1               | 1              |
| ▲       | B-423    | F A H              | 19.05              | 12.70               | –                  | M21-7-423         | M210, M210-LAB, M211  | R6000HF               | 1               | 1              |
| ⬢       | B-499    | F N A              | 19.05              | 23.80               | –                  | B33-91-499        | i3300, i5300          | B30 Monocolour        | 2500            | 4              |
| ▲       | B-499    | F N A              | 19.05              | 38.10               | –                  | M7-30-499         | M710                  | R4300                 | 250             | 1              |
| ⊙       | B-499    | F N A              | 19.05              | –                   | 4.88               | M21-750-499       | M210, M210-LAB, M211  | R4300                 | 1               | –              |
| ⊙       | B-499    | F N A              | 19.05              | –                   | 4.88               | MC-750-499        | BMP41, BMP51          | R4300                 | 1               | –              |
| ⊙       | B-595    | F                  | 19.05              | –                   | 6.10               | MC-750-595-CL-BK  | BMP41, BMP51          | R6000HF               | 1               | –              |
| ⊙       | B-595    | F                  | 19.05              | –                   | 6.10               | MC-750-595-CL-WT  | BMP41, BMP51          | R4400                 | 1               | –              |
| ⊙       | B-423    | F A H              | 19.05              | –                   | 6.40               | M21-750-423       | M210, M210-LAB, M211  | R6200                 | 1               | –              |
| ⊙       | B-430    | F A H              | 19.05              | –                   | 6.40               | M21-750-430       | M210, M210-LAB, M211  | R6200                 | 1               | –              |
| ⊙       | B-488    | F A                | 19.05              | –                   | 6.40               | M21-750-488       | M210, M210-LAB, M211  | R4300                 | 1               | –              |
| ⊙       | B-7425   | F N A H            | 19.05              | –                   | 6.40               | M21-750-7425      | M210, M210-LAB, M211  | R4300                 | 1               | –              |
| ⊙       | B-595    | F                  | 19.05              | –                   | 6.40               | M21-750-595-PL    | M210, M210-LAB, M211  | R4400                 | 1               | –              |
| ⊙       | B-595    | F                  | 19.05              | –                   | 6.40               | M21-750-595-BR    | M210, M210-LAB, M211  | R4400                 | 1               | –              |
| ⊙       | B-595    | F                  | 19.05              | –                   | 6.40               | M21-750-595-GY    | M210, M210-LAB, M211  | R6000HF               | 1               | –              |
| ⊙       | B-595    | F                  | 19.05              | –                   | 6.40               | M21-750-595-BK    | M210, M210-LAB, M211  | R4400                 | 1               | –              |
| ⊙       | B-430    | F A H              | 19.05              | –                   | 6.40               | M21-750-430-WT-CL | M210, M210-LAB, M211  | R6200                 | 1               | –              |
| ⊙       | B-595    | F                  | 19.05              | –                   | 6.40               | M21-750-595-BL    | M210, M210-LAB, M211  | R4400                 | 1               | –              |
| ⊙       | B-595    | F                  | 19.05              | –                   | 6.40               | M21-750-595-WT    | M210, M210-LAB, M211  | R6000HF               | 1               | –              |
| ⊙       | B-595    | F                  | 19.05              | –                   | 6.40               | M21-750-595-RD    | M210, M210-LAB, M211  | R4400                 | 1               | –              |
| ⊙       | B-595    | F                  | 19.05              | –                   | 6.40               | M21-750-595-OR    | M210, M210-LAB, M211  | R6000HF               | 1               | –              |
| ⊙       | B-595    | F                  | 19.05              | –                   | 6.40               | M21-750-595-GN    | M210, M210-LAB, M211  | R4400                 | 1               | –              |
| ⊙       | B-595    | F                  | 19.05              | –                   | 6.40               | M21-750-595-YL    | M210, M210-LAB, M211  | R6000HF               | 1               | –              |
| ⊙       | B-595    | F                  | 19.05              | –                   | 7.62               | MC-750-595-OR-BK  | BMP41, BMP51          | R6000HF               | 1               | –              |
| ⊙       | B-595    | F                  | 19.05              | –                   | 7.62               | MC-750-595-WT-BK  | BMP41, BMP51          | R6000HF               | 1               | –              |
| ⊙       | B-595    | F                  | 19.05              | –                   | 7.62               | MC-750-595-YL-BK  | BMP41, BMP51          | R6000HF               | 1               | –              |
| ⊙       | B-595    | F                  | 19.05              | –                   | 7.62               | MC-750-595-WT-RD  | BMP41, BMP51          | R4400                 | 1               | –              |
| ⊙       | B-595    | F                  | 19.05              | –                   | 7.62               | MC-750-595-BK-WT  | BMP41, BMP51          | R4400                 | 1               | –              |
| ⊙       | B-595    | F                  | 19.05              | –                   | 7.62               | MC-750-595-BL-WT  | BMP41, BMP51          | R4400                 | 1               | –              |
| ⊙       | B-595    | F                  | 19.05              | –                   | 7.62               | MC-750-595-GN-WT  | BMP41, BMP51          | R4400                 | 1               | –              |
| ⊙       | B-595    | F                  | 19.05              | –                   | 7.62               | MC-750-595-RD-WT  | BMP41, BMP51          | R4400                 | 1               | –              |

>>

# Well Plate Labels

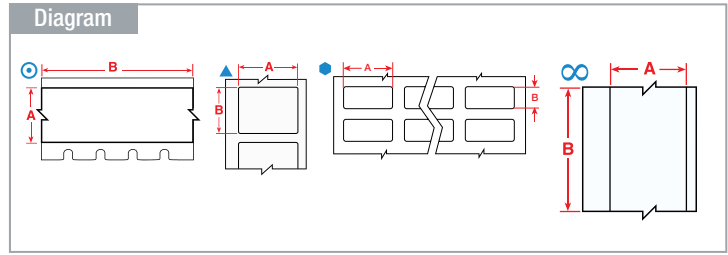
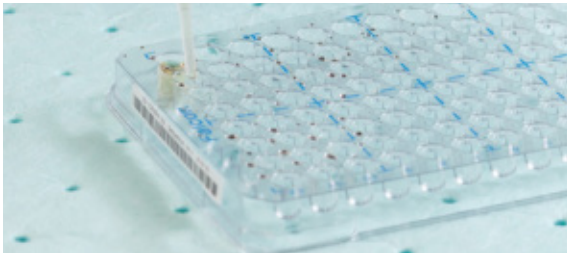

Labels are shown in order of label width.

The background colours in the Order Reference column represent the material colour.

See page 58 for Brady's range of label printers.

| Diagram | Material | Special Properties | Label Width A (mm) | Label Height B (mm) | Label Length B (m) | Order Reference | Printer Compatibility | Printer Ribbon Series | Labels per Roll              | Labels per Row |   |
|---------|----------|--------------------|--------------------|---------------------|--------------------|-----------------|-----------------------|-----------------------|------------------------------|----------------|---|
| ●       | B-498    | <b>F</b>           | <b>R</b>           | 20.32               | 36.50              | –               | B33-95-498            | i3300                 | B30 Monocolour               | 2300           | 3 |
| ●       | B-498    | <b>F</b>           | <b>R</b>           | 20.32               | 36.50              | –               | THT-95-498-5          | BBP12, i7100, i5100   | R4300, R7950                 | 5000           | 3 |
| ▲       | B-499    | <b>F N A</b>       |                    | 22.86               | 12.70              | –               | M7-84-499             | M710                  | R4300, R6000HF, R6200, R6900 | 500            | 1 |
| ●       | B-488    | <b>F A</b>         |                    | 22.86               | 19.05              | –               | B33-616-488           | i3300                 | B30-R4300                    | 3000           | 3 |
| ●       | B-488    | <b>F A</b>         |                    | 22.86               | 22.86              | –               | B33-617-488           | i3300                 | B30-R4300                    | 3000           | 3 |
| ▲       | B-423    | <b>F A H</b>       |                    | 25.40               | 4.75               | –               | M7-14-423             | M710                  | R6000HF                      | 750            | 1 |
| ▲       | B-423    | <b>F A</b>         |                    | 25.40               | 4.75               | –               | M6-14-423             | M610, M611            | R6000HF                      | 750            | 1 |
| ●       | B-423    | <b>F A H</b>       |                    | 25.40               | 4.75               | –               | THT-41-423-10         | BBP12, i7100, i5100   | R6000HF                      | 10000          | 3 |
| ●       | B-423    | <b>F A H</b>       |                    | 25.40               | 6.35               | –               | THT-51-423-10         | BBP12, i7100, i5100   | R6000HF                      | 10000          | 3 |
| ▲       | B-423    | <b>F A H</b>       |                    | 25.40               | 6.99               | –               | M7-15-423             | M710                  | R6000HF                      | 750            | 1 |
| ▲       | B-423    | <b>F A</b>         |                    | 25.40               | 6.99               | –               | M6-15-423             | M610, M611            | R6000HF                      | 750            | 1 |
| ●       | B-499    | <b>F N A</b>       |                    | 25.40               | 9.53               | –               | THT-152-499-1.5-SC    | BBP12                 | R7950, R4300, R4900          | 1500           | 2 |
| ●       | B-499    | <b>F N A</b>       |                    | 25.40               | 9.53               | –               | B33-152-499           | i3300                 | B30 Monocolour               | 1500           | 2 |
| ●       | B-499    | <b>F N A</b>       |                    | 25.40               | 9.53               | –               | THT-152-499-3         | BBP12, i7100, i5100   | R4900                        | 3000           | 2 |
| ●       | B-423    | <b>F A H</b>       |                    | 25.40               | 9.65               | –               | THT-31-423-10         | BBP12, i7100, i5100   | R6000HF                      | 10000          | 2 |
| ●       | B-425A   | <b>F</b>           |                    | 25.40               | 10.00              | –               | THT-30-425-10         | BBP12, i7100, i5100   | R6400                        | 10000          | 3 |
| ▲       | B-432    | <b>F A</b>         |                    | 25.40               | 12.70              | –               | M-17-432-CL-BK        | BMP51                 | R6000HF                      | 280            | – |
| ▲       | B-499    | <b>F N A</b>       |                    | 25.40               | 12.70              | –               | M21-131-499           | M210, M210-LAB, M211  | R4300                        | 1              | 1 |
| ▲       | B-423    | <b>F A H</b>       |                    | 25.40               | 12.70              | –               | M21-17-423            | M210, M210-LAB, M211  | R6000HF                      | 1              | 1 |
| ●       | B-499    | <b>F N A</b>       |                    | 25.40               | 12.70              | –               | B33-5-499             | i3300, i5300          | B30 Monocolour               | 5000           | 3 |
| ▲       | B-498    | <b>F</b>           | <b>R</b>           | 25.40               | 12.70              | –               | M7-17-498             | M710                  | R6200                        | 500            | 1 |
| ▲       | B-430    | <b>F A H</b>       |                    | 25.40               | 12.70              | –               | M7-17-430             | M710                  | R6000HF                      | 500            | 1 |
| ▲       | B-423    | <b>F A H</b>       |                    | 25.40               | 12.70              | –               | M7-17-423             | M710                  | R6000HF                      | 500            | 1 |
| ▲       | B-423    | <b>F A</b>         |                    | 25.40               | 12.70              | –               | M6-17-423             | M610, M611            | R6000HF, R4400               | 500            | 1 |
| ▲       | B-430    | <b>F A H</b>       |                    | 25.40               | 12.70              | –               | M6-17-430             | M610, M611            | R6000HF                      | 500            | 1 |
| ▲       | B-498    | <b>F</b>           | <b>R</b>           | 25.40               | 12.70              | –               | M6-17-498             | M610, M611            | R6200                        | 500            | 1 |
| ●       | B-430    | <b>F A H</b>       |                    | 25.40               | 12.70              | –               | THT-39-430-10         | BBP12, i7100, i5100   | R6000HF                      | 10000          | 3 |
| ▲       | B-499    | <b>F N A</b>       |                    | 25.40               | 19.05              | –               | M21-18-499            | M210, M210-LAB, M211  | R4300                        | 1              | 1 |
| ▲       | B-423    | <b>F A H</b>       |                    | 25.40               | 19.05              | –               | M21-18-423            | M210, M210-LAB, M211  | R6000HF                      | 1              | 1 |
| ●       | B-499    | <b>F N A</b>       |                    | 25.40               | 19.05              | –               | B33-88-499            | i3300, i5300          | B30 Monocolour               | 2500           | 2 |
| ●       | B-498    | <b>F</b>           | <b>R</b>           | 25.40               | 36.50              | –               | BPT-621-498           | BBP12                 | R7950                        | 3000           | 3 |
| ●       | B-498    | <b>F</b>           | <b>R</b>           | 25.40               | 36.50              | –               | THT-89-498-5          | BBP12, i7100, i5100   | R4300, R7950                 | 5000           | 3 |
| ▲       | B-499    | <b>F N A</b>       |                    | 25.40               | 38.10              | –               | M7-31-499             | M710                  | R4300, R6000HF, R6200        | 250            | 1 |
| ▲       | B-498    | <b>F</b>           | <b>R</b>           | 25.40               | 38.10              | –               | M7-31-498             | M710                  | R6200                        | 250            | 1 |
| ▲       | B-490    | <b>F N H L</b>     |                    | 25.40               | 44.45              | –               | M6-203-490            | M610, M611            | R4300                        | 250            | 1 |
| ▲       | B-423    | <b>F A H</b>       |                    | 25.40               | 50.80              | –               | M7-20-423             | M710                  | R6000HF                      | 100            | 1 |
| ▲       | B-423    | <b>F A</b>         |                    | 25.40               | 50.80              | –               | M6-20-423             | M610, M611            | R6000HF                      | 100            | 1 |
| ○       | B-499    | <b>F N A</b>       |                    | 25.40               | –                  | 4.88            | MC-1000-499           | BMP51                 | R4300                        | 1              | – |
| ○       | B-595    | <b>F</b>           |                    | 25.40               | –                  | 6.10            | MC1-1000-595-CL-BK    | BMP41, BMP51          | R6000HF                      | 1              | – |
| ○       | B-595    | <b>F</b>           |                    | 25.40               | –                  | 6.10            | MC1-1000-595-CL-WT    | BMP41, BMP51          | R4400                        | 1              | – |
| ○       | B-595    | <b>F</b>           |                    | 25.40               | –                  | 7.62            | MC1-1000-595-WT-BK    | BMP41, BMP51          | R6000HF                      | 1              | – |
| ○       | B-595    | <b>F</b>           |                    | 25.40               | –                  | 7.62            | MC1-1000-595-YL-BK    | BMP41, BMP51          | R6000HF                      | 1              | – |
| ○       | B-595    | <b>F</b>           |                    | 25.40               | –                  | 7.62            | MC1-1000-595-OR-BK    | BMP41, BMP51          | R6000HF                      | 1              | – |
| ○       | B-595    | <b>F</b>           |                    | 25.40               | –                  | 7.62            | MC1-1000-595-BL-WT    | BMP41, BMP51          | R4400                        | 1              | – |
| ○       | B-595    | <b>F</b>           |                    | 25.40               | –                  | 7.62            | MC1-1000-595-RD-WT    | BMP41, BMP51          | R4400                        | 1              | – |
| ○       | B-595    | <b>F</b>           |                    | 25.40               | –                  | 7.62            | MC1-1000-595-GN-WT    | BMP41, BMP51          | R4400                        | 1              | – |
| ○       | B-595    | <b>F</b>           |                    | 25.40               | –                  | 7.62            | MC1-1000-595-WT-RD    | BMP41, BMP51          | R4400                        | 1              | – |
| ○       | B-595    | <b>F</b>           |                    | 25.40               | –                  | 7.62            | MC1-1000-595-BK-WT    | BMP41, BMP51          | R4400                        | 1              | – |
| ○       | B-499    | <b>F N A</b>       |                    | 25.40               | –                  | 9.14            | M7C-1000-499          | M710                  | R4300, R6000HF, R6200        | 1              | 1 |
| ○       | B-595    | <b>F</b>           |                    | 25.40               | –                  | 15.24           | M7C-1000-595-YL       | M710                  | R6000HF, R4400-WT            | 1              | 1 |
| ○       | B-595    | <b>F</b>           |                    | 25.40               | –                  | 15.24           | M7C-1000-595-WT       | M710                  | R6000HF                      | 1              | 1 |
| ○       | B-595    | <b>F</b>           |                    | 25.40               | –                  | 15.24           | M7C-1000-595-RD       | M710                  | R6000HF, R4400-WT            | 1              | 1 |
| ○       | B-595    | <b>F</b>           |                    | 25.40               | –                  | 15.24           | M7C-1000-595-OR       | M710                  | R6000HF, R4400-WT            | 1              | 1 |
| ○       | B-595    | <b>F</b>           |                    | 25.40               | –                  | 15.24           | M7C-1000-595-GN       | M710                  | R6000HF, R4400-WT            | 1              | 1 |
| ○       | B-595    | <b>F</b>           |                    | 25.40               | –                  | 15.24           | M7C-1000-595-CL       | M710                  | R6000HF, R4400-WT            | 1              | 1 |
| ○       | B-595    | <b>F</b>           |                    | 25.40               | –                  | 15.24           | M7C-1000-595-BL       | M710                  | R6000HF, R4400-WT            | 1              | 1 |

>>

**F** Freezer environment **N** Liquid nitrogen environment **A** Autoclave environment **H** Hot water bath (100°C) **S** Self-laminating label **L** Low-profile (extremely thin) label **R** Removable

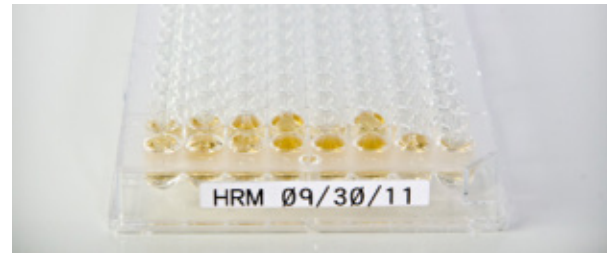
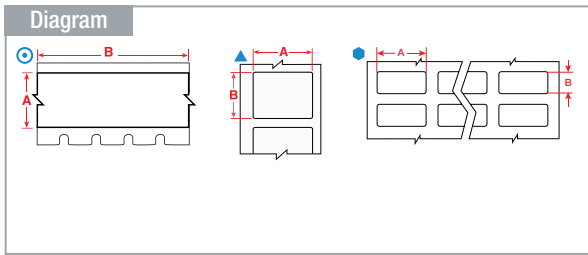

Labels are shown in order of label width.

The background colours in the Order Reference column represent the material colour.

See page 58 for Brady's range of label printers.

| Diagram | Material | Special Properties | Label Width A (mm) | Label Height B (mm) | Label Length B (m) | Order Reference    | Printer Compatibility | Printer Ribbon Series | Labels per Roll | Labels per Row |
|---------|----------|--------------------|--------------------|---------------------|--------------------|--------------------|-----------------------|-----------------------|-----------------|----------------|
| ⊙       | B-595    | F                  | 25.40              | –                   | 15.24              | M7C-1000-595-BK    | M710                  | R4400-WT              | 1               | 1              |
| ⊙       | B-430    | F A H              | 25.40              | –                   | 15.24              | M7C-1000-430       | M710                  | R6000HF               | 1               | 1              |
| ∞       | B-439    | F                  | 25.40              | –                   | 15.24              | M6C-1000-439       | M610, M611            | R6000HF               | 1               | 1              |
| ∞       | B-439    | F                  | 25.40              | –                   | 15.24              | M6C-1000-439-OR    | M610, M611            | R6000HF               | 1               | 1              |
| ∞       | B-439    | F                  | 25.40              | –                   | 15.24              | M6C-1000-439-RD    | M610, M611            | R6000HF               | 1               | 1              |
| ∞       | B-439    | F                  | 25.40              | –                   | 15.24              | M6C-1000-439-YL    | M610, M611            | R6000HF               | 1               | 1              |
| ▲       | B-498    | F R                | 38.10              | 12.70               | –                  | M7-29-498          | M710                  | R6200                 | 500             | 1              |
| ▲       | B-498    | F R                | 38.10              | 12.70               | –                  | M6-29-498          | M610, M611            | R6200                 | 500             | 1              |
| ●       | B-423    | F A H              | 38.10              | 12.70               | –                  | THT-37-423-10      | BBP12, i7100, i5100   | R6000HF               | 10000           | 2              |
| ▲       | B-499    | F N A              | 38.10              | 19.05               | –                  | THT-136-499-1.5-SC | BBP12                 | R7950, R4300, R4900   | 1500            | 1              |
| ▲       | B-499    | F N A              | 38.10              | 19.05               | –                  | B33-136-499        | i3300                 | B30 Monocolour        | 1500            | 1              |
| ▲       | B-499    | F N A              | 38.10              | 19.05               | –                  | M21-136-499        | M210, M210-LAB, M211  | R4300                 | 1               | 1              |
| ▲       | B-423    | F A H              | 38.10              | 19.05               | –                  | M21-30-423         | M210, M210-LAB, M211  | R6000HF               | 1               | 1              |
| ▲       | B-499    | F N A              | 38.10              | 19.05               | –                  | M6-30-499          | M610, M611            | R4300, R6000HF, R6200 | 250             | 1              |
| ●       | B-8423   | F A                | 38.10              | 19.05               | –                  | BPT-6-8423-2.5     | BBP12                 | R6000HF               | 2500            | 2              |
| ▲       | B-499    | F N A              | 38.10              | 19.05               | –                  | THT-136-499-3      | BBP12, i7100, i5100   | R4900                 | 3000            | 1              |
| ▲       | B-423    | F A H              | 38.10              | 25.40               | –                  | M7-31-423          | M710                  | R6000HF               | 250             | 1              |
| ▲       | B-423    | F A                | 38.10              | 25.40               | –                  | M6-31-423          | M610, M611            | R6000HF               | 250             | 1              |
| ▲       | B-498    | F R                | 38.10              | 25.40               | –                  | M6-31-498          | M610, M611            | R6200                 | 250             | 1              |
| ▲       | B-499    | F N A              | 38.10              | 25.40               | –                  | M6-31-499          | M610, M611            | R4300, R6000HF, R6200 | 250             | 1              |
| ▲       | B-490    | F N H L            | 38.10              | 55.88               | –                  | M6-113-490         | M610, M611            | R4300                 | 100             | 1              |
| ▲       | B-490    | F N H L            | 38.10              | 98.43               | –                  | M6-114-490         | M610, M611            | R4300                 | 100             | 1              |
| ▲       | B-488    | F A                | 48.26              | 6.35                | –                  | M-81-488           | BMP41, BMP51          | R4300                 | 160             | –              |
| ▲       | B-499    | F N A              | 48.26              | 6.35                | –                  | M7-81-499          | M710                  | R4300                 | 750             | 1              |
| ▲       | B-488    | F A                | 48.26              | 6.35                | –                  | M7-81-488          | M710                  | R4300                 | 750             | 1              |
| ▲       | B-488    | F A                | 48.26              | 6.35                | –                  | M6-81-488          | M610, M611            | R4300                 | 750             | 1              |
| ▲       | B-499    | F N A              | 48.26              | 6.35                | –                  | M6-81-499          | M610, M611            | R4300, R6000HF, R6200 | 750             | 1              |
| ▲       | B-488    | F A                | 48.26              | 6.35                | –                  | BPT-635-488        | BBP12                 | R7950                 | 2000            | 1              |
| ▲       | B-488    | F A                | 48.26              | 6.35                | –                  | B33-635-488        | i3300                 | B30-R4300             | 2000            | 1              |
| ▲       | B-499    | F N A              | 48.26              | 25.40               | –                  | M7-78-499          | M710                  | R4300                 | 250             | 1              |
| ▲       | B-488    | F A                | 48.26              | 25.40               | –                  | M6-78-488          | M610, M611            | R4300                 | 250             | 1              |
| ▲       | B-499    | F N A              | 48.26              | 25.40               | –                  | M6-78-499          | M610, M611            | R4300, R6000HF, R6200 | 250             | 1              |
| ⊙       | B-499    | F N A              | 48.26              | –                   | 9.14               | M7C-1900-499       | M710                  | R4300, R6000HF, R6200 | 1               | 1              |
| ▲       | B-499    | F N A              | 50.80              | 6.35                | –                  | THT-151-499-1.5-SC | BBP12                 | R7950, R4300, R4900   | 1500            | 1              |
| ▲       | B-499    | F N A              | 50.80              | 6.35                | –                  | B33-151-499        | i3300                 | B30 Monocolour        | 1500            | 1              |
| ▲       | B-423    | F A H              | 50.80              | 6.35                | –                  | M7-2-423           | M710                  | R6000HF               | 100             | 1              |
| ▲       | B-423    | F A                | 50.80              | 6.35                | –                  | M6-2-423           | M610, M611            | R6000HF               | 100             | 1              |
| ▲       | B-423    | F A H              | 50.80              | 6.35                | –                  | THT-15-423-2.5     | BBP12, i7100, i5100   | R6000HF               | 2500            | 1              |
| ▲       | B-499    | F N A              | 50.80              | 6.35                | –                  | THT-151-499-3      | BBP12, i7100, i5100   | R4900                 | 3000            | 1              |
| ▲       | B-499    | F N A              | 50.80              | 19.05               | –                  | M21-137-499        | M210, M210-LAB, M211  | R4300                 | 1               | 1              |
| ▲       | B-423    | F A H              | 50.80              | 19.05               | –                  | M21-137-423        | M210, M210-LAB, M211  | R6000HF               | 1               | 1              |
| ▲       | B-423    | F A H              | 50.80              | 25.40               | –                  | BM-20-423          | M610, M611, M710      | R6000HF               | 1000            | 1              |
| ⊙       | B-430    | F A H              | 50.80              | –                   | 15.24              | M7C-1900-430       | M710                  | R6000HF               | 1               | 1              |
| ▲       | B-423    | F A H              | 63.50              | 5.08                | –                  | THT-142-423-2.5    | BBP12, i7100, i5100   | R6000HF               | 2500            | 1              |
| ▲       | B-423    | F A H              | 76.20              | 25.40               | –                  | M7-22-423          | M710                  | R6000HF               | 100             | 1              |
| ▲       | B-423    | F A                | 76.20              | 25.40               | –                  | M6-22-423          | M610, M611            | R6000HF               | 100             | 1              |
| ▲       | B-430    | F A H              | 76.20              | 25.40               | –                  | THT-18-430-3       | BBP12, i7100, i5100   | R6000HF               | 3000            | 1              |
| ▲       | B-430    | F A H              | 76.20              | 50.80               | –                  | THT-19-430-1       | BBP12, i7100, i5100   | R6000HF               | 1000            | 1              |

## Part number explanation

Most Brady references for printable labels follow the same three-part format: The first code indicates the technology, the second part is a number indicating the label size (where applicable) and the third part indicates the Brady material (where applicable).

## M7-73-461

BMP71  
Technology

Label size  
code

Material  
(B-number)



## Bottles / Flasks & Dishes

Brady's labels for bottles, flasks and dishes are easy to handle and flexible. This enables the labels to be placed on curved containers and remain attached and legible, even after being subjected to freezing, liquid nitrogen and heat.

- F** Freezer environment
- N** Liquid nitrogen environment
- A** Autoclave environment
- H** Hot water bath (100°C)
- S** Self-laminating label
- L** Low-profile (extremely thin) label
- R** Removable

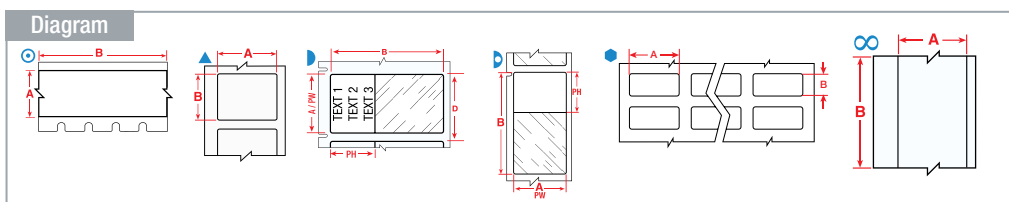

Labels are shown in order of label width.

The background colours in the Order Reference column represent the material colour.

See page 58 for Brady's range of label printers.

| Diagram | Material | Special Properties | Label Width A (mm) | Label Height B (mm) | Label Length B (m) | Printable Area Width PW (mm) | Printable Area Height PH (mm) | Order Reference   | Printer Compatibility | Printer Ribbon Series | Labels per Roll | Labels per Row |
|---------|----------|--------------------|--------------------|---------------------|--------------------|------------------------------|-------------------------------|-------------------|-----------------------|-----------------------|-----------------|----------------|
| ⊙       | B-499    | <b>F N A</b>       | 6.35               | 36.50               | —                  | —                            | —                             | B33-90-499        | i3300, i5300          | B30 Monocolour        | 2500            | 6              |
| ⊙       | B-430    | <b>F A H</b>       | 6.35               | —                   | 6.40               | —                            | —                             | M21-250-430       | M210, M210-LAB, M211  | R6200                 | 1               | —              |
| ⊙       | B-430    | <b>F A H</b>       | 6.35               | —                   | 6.40               | —                            | —                             | M21-250-430-WT-CL | M210, M210-LAB, M211  | R6200                 | 1               | —              |
| ⊙       | B-423    | <b>F A H</b>       | 6.35               | —                   | 6.40               | —                            | —                             | M21-250-423       | M210, M210-LAB, M211  | R6200                 | 1               | —              |
| ▲       | B-499    | <b>F N A</b>       | 9.53               | 20.96               | —                  | —                            | —                             | M-130-499         | BMP41, BMP51          | R4300                 | 220             | —              |
| ⊙       | B-499    | <b>F N A</b>       | 9.53               | —                   | 4.88               | —                            | —                             | M21-375-499       | M210, M210-LAB, M211  | R4300                 | 1               | —              |
| ⊙       | B-499    | <b>F N A</b>       | 9.53               | —                   | 4.88               | —                            | —                             | MC-375-499        | BMP41, BMP51          | R4300                 | 1               | —              |
| ⊙       | B-430    | <b>F A H</b>       | 9.53               | —                   | 6.40               | —                            | —                             | M21-375-430       | M210, M210-LAB, M211  | R6200                 | 1               | —              |
| ⊙       | B-430    | <b>F A H</b>       | 9.53               | —                   | 6.40               | —                            | —                             | M21-375-430-WT-CL | M210, M210-LAB, M211  | R6200                 | 1               | —              |
| ⊙       | B-461    | <b>F N A H S L</b> | 9.53               | —                   | 15.24              | —                            | —                             | M6C-375-461       | M610, M611            | R4300, R6200          | 1               | 1              |
| ⊙       | B-430    | <b>F A H</b>       | 9.53               | —                   | 15.24              | —                            | —                             | M7C-375-430       | M710                  | R6000HF               | 1               | 1              |
| ▲       | B-423    | <b>F A H</b>       | 12.70              | 12.70               | —                  | —                            | —                             | BM-7-423          | M610, M611, M710      | R6000HF               | 5000            | 1              |
| ▲       | B-499    | <b>F N A</b>       | 12.70              | 12.70               | —                  | —                            | —                             | M6-7-499          | M610, M611            | R4300, R6000HF, R6200 | 500             | 1              |
| ▲       | B-498    | <b>F</b>           | 12.70              | 12.70               | —                  | —                            | —                             | M6-7-498          | M610, M611            | R6200                 | 500             | 1              |
| ▲       | B-423    | <b>F A</b>         | 12.70              | 12.70               | —                  | —                            | —                             | M6-7-423          | M610, M611            | R6000HF               | 500             | 1              |
| ▲       | B-423    | <b>F A H</b>       | 12.70              | 12.70               | —                  | —                            | —                             | M7-7-423          | M710                  | R6000HF               | 500             | 1              |
| ⊙       | B-427    | <b>F N S</b>       | 12.70              | 19.05               | —                  | 12.70                        | 9.53                          | M21-11-427        | M210, M210-LAB, M211  | R4300, R4500          | 1               | 1              |
| ⊙       | B-499    | <b>F N A</b>       | 12.70              | 19.05               | —                  | —                            | —                             | B33-68-499        | i3300                 | B30 Monocolour        | 1500            | 4              |
| ▲       | B-432    | <b>F A</b>         | 12.70              | 19.05               | —                  | —                            | —                             | M6-11-432         | M610, M611            | R6000HF               | 500             | 1              |
| ⊙       | B-499    | <b>F N A</b>       | 12.70              | 19.05               | —                  | —                            | —                             | THT-68-499-10     | BBP12, i7100, i5100   | R4900                 | 10000           | 4              |
| ▲       | B-499    | <b>F N A</b>       | 12.70              | 25.40               | —                  | —                            | —                             | M-131-499         | BMP41, BMP51          | R4300                 | 180             | —              |
| ▲       | B-498    | <b>F</b>           | 12.70              | 25.40               | —                  | —                            | —                             | M-131-498         | BMP41, BMP51          | R6200                 | 180             | —              |
| ⊙       | B-499    | <b>F N A</b>       | 12.70              | 36.50               | —                  | —                            | —                             | B33-87-499        | i3300, i5300          | B30 Monocolour        | 2500            | 6              |
| ▲       | B-499    | <b>F N A</b>       | 12.70              | 38.10               | —                  | —                            | —                             | M6-29-499         | M610, M611            | R4300, R6000HF, R6200 | 500             | 1              |
| ▲       | B-499    | <b>F N A</b>       | 12.70              | 38.10               | —                  | —                            | —                             | M7-29-499         | M710                  | R6200                 | 500             | 1              |
| ▲       | B-492    | <b>F N H L</b>     | 12.70              | 41.91               | —                  | —                            | —                             | M6-124-492        | M610, M611            | R4300, R6400          | 500             | 1              |
| ⊙       | B-499    | <b>F N A</b>       | 12.70              | —                   | 4.88               | —                            | —                             | M21-500-499       | M210, M210-LAB, M211  | R4300                 | 1               | —              |
| ⊙       | B-499    | <b>F N A</b>       | 12.70              | —                   | 4.88               | —                            | —                             | MC-500-499        | BMP41, BMP51          | R4300                 | 1               | —              |
| ⊙       | B-430    | <b>F A H</b>       | 12.70              | —                   | 6.40               | —                            | —                             | M21-500-430       | M210, M210-LAB, M211  | R6200                 | 1               | —              |
| ⊙       | B-430    | <b>F A H</b>       | 12.70              | —                   | 6.40               | —                            | —                             | M21-500-430-WT-CL | M210, M210-LAB, M211  | R6200                 | 1               | —              |
| ⊙       | B-499    | <b>F N A</b>       | 12.70              | —                   | 9.14               | —                            | —                             | M7C-500-499       | M710                  | R4300, R6000HF, R6200 | 1               | 1              |
| ⊙       | B-461    | <b>F N A H S L</b> | 12.70              | —                   | 15.24              | —                            | —                             | M6C-500-461       | M610, M611            | R4300, R6200          | 1               | 1              |
| ⊙       | B-430    | <b>F A H</b>       | 12.70              | —                   | 15.24              | —                            | —                             | M6C-500-430       | M610, M611            | R6000HF               | 1               | 1              |
| ⊙       | B-430    | <b>F A H</b>       | 12.70              | —                   | 15.24              | —                            | —                             | M7C-500-430       | M710                  | R6000HF               | 1               | 1              |
| ⊙       | B-492    | <b>F H L</b>       | 15.24              | 41.28               | —                  | —                            | —                             | M6-205-492        | M610, M611            | R4300, R6400          | 250             | 1              |
| ⊙       | B-499    | <b>F N A</b>       | 19.05              | 6.35                | —                  | —                            | —                             | B33-1-499         | i3300, i5300          | B30 Monocolour        | 10000           | 4              |
| ▲       | B-499    | <b>F N A</b>       | 19.05              | 12.70               | —                  | —                            | —                             | M21-11-499        | M210, M210-LAB, M211  | R4300                 | 1               | 1              |
| ▲       | B-423    | <b>F A H</b>       | 19.05              | 12.70               | —                  | —                            | —                             | M21-7-423         | M210, M210-LAB, M211  | R6000HF               | 1               | 1              |
| ▲       | B-499    | <b>F N A</b>       | 19.05              | 19.05               | —                  | —                            | —                             | B33-254-499       | i3300, i5300          | B30 Monocolour        | 1000            | 1              |
| ▲       | B-498    | <b>F</b>           | 19.05              | 19.05               | —                  | —                            | —                             | B33-254-498       | i3300, i5300          | B30 Monocolour        | 1000            | 1              |
| ⊙       | B-488    | <b>F A</b>         | 19.05              | 22.86               | —                  | —                            | —                             | THT-140-488-3     | BBP12, i7100, i5100   | R4300, R7950          | 3000            | 2              |

>>>



# Bottles / Flasks & Dishes

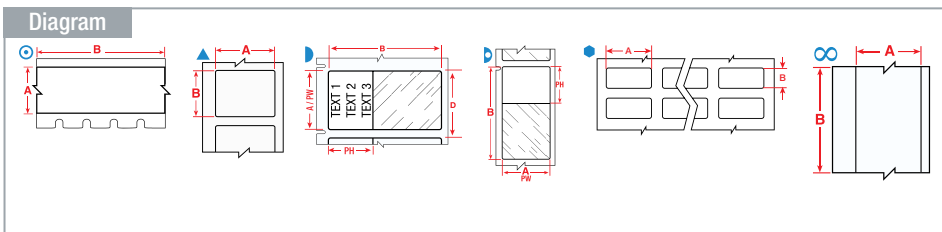

Labels are shown in order of label width.

The background colours in the Order Reference column represent the material colour.

See page 58 for Brady's range of label printers.

| Diagram | Material | Special Properties | Label Width A (mm) | Label Height B (mm) | Label Length B (m) | Printable Area Width PW (mm) | Printable Area Height PH (mm) | Order Reference    | Printer Compatibility | Printer Ribbon Series | Labels per Roll | Labels per Row |
|---------|----------|--------------------|--------------------|---------------------|--------------------|------------------------------|-------------------------------|--------------------|-----------------------|-----------------------|-----------------|----------------|
| ▲       | B-423    | <b>F AH</b>        | 25.40              | 19.05               | -                  | -                            | -                             | M21-18-423         | M210, M210-LAB, M211  | R6000HF               | 1               | 1              |
| ●       | B-492    | <b>F N H L</b>     | 25.40              | 19.05               | -                  | -                            | -                             | THT-88-492-5       | BBP12, i7100, i5100   | R6400                 | 5000            | 2              |
| ▲       | B-494    | <b>F N H</b>       | 25.40              | 25.40               | -                  | 25.40                        | 22.23                         | M6-19-494-BL       | M611, M610            | R6400                 | 250             | 1              |
| ▲       | B-494    | <b>F N H</b>       | 25.40              | 25.40               | -                  | 25.40                        | 22.23                         | M6-19-494-GN       | M611, M610            | R6400                 | 250             | 1              |
| ▲       | B-494    | <b>F N H</b>       | 25.40              | 25.40               | -                  | 25.40                        | 22.23                         | M6-19-494-OR       | M611, M610            | R6400                 | 250             | 1              |
| ▲       | B-494    | <b>F N H</b>       | 25.40              | 25.40               | -                  | 25.40                        | 22.23                         | M6-19-494-PK       | M611, M610            | R6400                 | 250             | 1              |
| ▲       | B-494    | <b>F N H</b>       | 25.40              | 25.40               | -                  | 25.40                        | 22.23                         | M6-19-494-RD       | M611, M610            | R6400                 | 250             | 1              |
| ▲       | B-494    | <b>F N H</b>       | 25.40              | 25.40               | -                  | 25.40                        | 22.23                         | M6-19-494-YL       | M611, M610            | R6400                 | 250             | 1              |
| ▲       | B-492    | <b>F N H L</b>     | 25.40              | 25.40               | -                  | -                            | -                             | M6-19-492          | M610, M611            | R4300, R6400          | 250             | 1              |
| ▲       | B-499    | <b>F N A</b>       | 25.40              | 25.40               | -                  | -                            | -                             | M7-19-499          | M710                  | R4300                 | 250             | 1              |
| ▲       | B-492    | <b>F N H L</b>     | 25.40              | 25.40               | -                  | -                            | -                             | M7-19-492          | M710                  | R6400                 | 250             | 1              |
| ▲       | B-498    | <b>F R</b>         | 25.40              | 31.75               | -                  | -                            | -                             | M-103-498          | BMP51                 | R6200                 | 160             | -              |
| ●       | B-499    | <b>F N A</b>       | 25.40              | 36.50               | -                  | -                            | -                             | B33-89-499         | i3300, i5300          | B30 Monocolour        | 2300            | 3              |
| ▷       | B-427    | <b>F N S</b>       | 25.40              | 38.10               | -                  | 25.40                        | 12.70                         | BM-31-427          | M610, M611, M710      | R4300                 | 2500            | 1              |
| ▷       | B-427    | <b>F N S</b>       | 25.40              | 38.10               | -                  | 25.40                        | 12.70                         | M-91-427           | BMP41, BMP51          | R4300                 | 180             | -              |
| ▷       | B-427    | <b>F N S</b>       | 25.40              | 38.10               | -                  | 25.40                        | 12.70                         | M7-31-427          | M710                  | R4300                 | 250             | 1              |
| ▲       | B-499    | <b>F N A</b>       | 25.40              | 38.10               | -                  | -                            | -                             | M7-31-499          | M710                  | R4300, R6000HF, R6200 | 250             | 1              |
| ▲       | B-492    | <b>F N H L</b>     | 25.40              | 44.45               | -                  | -                            | -                             | M6-203-492         | M610, M611            | R4300, R6400          | 250             | 1              |
| ▲       | B-490    | <b>F N H L</b>     | 25.40              | 44.45               | -                  | -                            | -                             | M6-203-490         | M610, M611            | R4300                 | 250             | 1              |
| ▲       | B-492    | <b>F N H L</b>     | 25.40              | 48.26               | -                  | -                            | -                             | M6-204-492         | M610, M611            | R4300, R6400          | 250             | 1              |
| ▲       | B-7351   | <b>F</b>           | 25.40              | 50.80               | -                  | -                            | -                             | M6-20-7351         | M611, M610, M710      | R6000HF               | 100             | 1              |
| ▲       | B-423    | <b>F A</b>         | 25.40              | 50.80               | -                  | -                            | -                             | M6-20-423          | M610, M611            | R6000HF               | 100             | 1              |
| ▲       | B-423    | <b>F AH</b>        | 25.40              | 50.80               | -                  | -                            | -                             | M7-20-423          | M710                  | R6000HF               | 100             | 1              |
| ▷       | B-427    | <b>F N S</b>       | 25.40              | 63.50               | -                  | 25.40                        | 19.05                         | M6-21-427          | M611, M610, M710      | R4300, R6200, R4400   | 100             | 1              |
| ●       | B-499    | <b>F N A</b>       | 25.40              | 63.50               | -                  | -                            | -                             | B33-325-499        | i3300, i5300          | B30 Monocolour        | 700             | 2              |
| ●       | B-498    | <b>F R</b>         | 25.40              | 63.50               | -                  | -                            | -                             | B33-325-498        | i3300, i5300          | B30 Monocolour        | 700             | 2              |
| ●       | B-499    | <b>F N A</b>       | 25.40              | 101.60              | -                  | -                            | -                             | B33-326-499        | i3300, i5300          | B30 Monocolour        | 450             | 2              |
| ●       | B-498    | <b>F R</b>         | 25.40              | 101.60              | -                  | -                            | -                             | B33-326-498        | i3300, i5300          | B30 Monocolour        | 450             | 2              |
| ○       | B-499    | <b>F N A</b>       | 25.40              | -                   | 4.88               | -                            | -                             | MC-1000-499        | BMP51                 | R4300                 | 1               | -              |
| ○       | B-499    | <b>F N A</b>       | 25.40              | -                   | 9.14               | -                            | -                             | M7C-1000-499       | M710                  | R4300, R6000HF, R6200 | 1               | 1              |
| ∞       | B-439    | <b>F</b>           | 25.40              | -                   | 15.24              | -                            | -                             | M6C-1000-439       | M610, M611            | R6000HF               | 1               | 1              |
| ∞       | B-439    | <b>F</b>           | 25.40              | -                   | 15.24              | -                            | -                             | M6C-1000-439-OR    | M610, M611            | R6000HF               | 1               | 1              |
| ∞       | B-439    | <b>F</b>           | 25.40              | -                   | 15.24              | -                            | -                             | M6C-1000-439-RD    | M610, M611            | R6000HF               | 1               | 1              |
| ∞       | B-439    | <b>F</b>           | 25.40              | -                   | 15.24              | -                            | -                             | M6C-1000-439-YL    | M610, M611            | R6000HF               | 1               | 1              |
| ○       | B-430    | <b>F AH</b>        | 25.40              | -                   | 15.24              | -                            | -                             | M7C-1000-430       | M710                  | R6000HF               | 1               | 1              |
| ▲       | B-498    | <b>F R</b>         | 26.67              | 6.35                | -                  | -                            | -                             | THT-199-498-3      | BBP12, i7100, i5100   | R4300, R7950          | 3000            | 1              |
| ▲       | B-498    | <b>F R</b>         | 26.67              | 6.35                | -                  | -                            | -                             | THT-199-498-3-SC   | BBP12                 | R7950                 | 3000            | 1              |
| ▷       | B-461    | <b>F N A H S L</b> | 28.58              | 9.53                | -                  | 19.05                        | 9.53                          | M6-123-461         | M610, M611            | R4300, R6200          | 500             | 1              |
| ▷       | B-461    | <b>F N A H S L</b> | 28.58              | 12.70               | -                  | 19.05                        | 12.70                         | M6-122-461         | M610, M611            | R4300, R6200          | 500             | 1              |
| ▲       | B-498    | <b>F R</b>         | 38.10              | 12.70               | -                  | -                            | -                             | M6-29-498          | M610, M611            | R6200                 | 500             | 1              |
| ●       | B-8423   | <b>F A</b>         | 38.10              | 19.05               | -                  | -                            | -                             | B33-600-8423       | i3300                 | B30-R6000HF           | 2500            | 2              |
| ▲       | B-499    | <b>F N A</b>       | 38.10              | 19.05               | -                  | -                            | -                             | B33-136-499        | i3300                 | B30 Monocolour        | 1500            | 1              |
| ▲       | B-499    | <b>F N A</b>       | 38.10              | 19.05               | -                  | -                            | -                             | M6-30-499          | M610, M611            | R4300, R6000HF, R6200 | 250             | 1              |
| ▲       | B-427    | <b>F N</b>         | 38.10              | 19.05               | -                  | -                            | -                             | M6-30-427-AW**     | M610, M611            | R4300                 | 250             | 1              |
| ▲       | B-427    | <b>F N S</b>       | 38.10              | 19.05               | -                  | -                            | -                             | M7-30-427-AW**     | M710                  | R4300                 | 250             | 1              |
| ▲       | B-499    | <b>F N A</b>       | 38.10              | 19.05               | -                  | -                            | -                             | M21-136-499        | M210, M210-LAB, M211  | R4300                 | 1               | 1              |
| ▲       | B-423    | <b>F AH</b>        | 38.10              | 19.05               | -                  | -                            | -                             | M21-30-423         | M210, M210-LAB, M211  | R6000HF               | 1               | 1              |
| ▲       | B-499    | <b>F N A</b>       | 38.10              | 19.05               | -                  | -                            | -                             | THT-136-499-3      | BBP12, i7100, i5100   | R4900                 | 3000            | 1              |
| ▲       | B-499    | <b>F N A</b>       | 38.10              | 19.05               | -                  | -                            | -                             | THT-136-499-1.5-SC | BBP12                 | R7950, R4300, R4900   | 1500            | 1              |
| ▲       | B-7351   | <b>F</b>           | 38.10              | 25.40               | -                  | -                            | -                             | M6-31-7351         | M611, M610, M710      | R6000HF               | 250             | 1              |
| ▲       | B-499    | <b>F N A</b>       | 38.10              | 25.40               | -                  | -                            | -                             | M6-31-499          | M610, M611            | R4300, R6000HF, R6200 | 250             | 1              |
| ▲       | B-498    | <b>F R</b>         | 38.10              | 25.40               | -                  | -                            | -                             | M6-31-498          | M610, M611            | R6200                 | 250             | 1              |
| ▲       | B-423    | <b>F A</b>         | 38.10              | 25.40               | -                  | -                            | -                             | M6-31-423          | M610, M611            | R6000HF               | 250             | 1              |
| ▲       | B-423    | <b>F AH</b>        | 38.10              | 25.40               | -                  | -                            | -                             | M7-31-423          | M710                  | R6000HF               | 250             | 1              |
| ▲       | B-499    | <b>F N A</b>       | 38.10              | 31.75               | -                  | -                            | -                             | M-132-499          | BMP51                 | R4300                 | 160             | -              |

\*\*AW = All White / no transparent area.

>>>

**F** Freezer environment **N** Liquid nitrogen environment **A** Autoclave environment **H** Hot water bath (100°C) **S** Self-laminating label **L** Low-profile (extremely thin) label **R** Removable



## Diagram

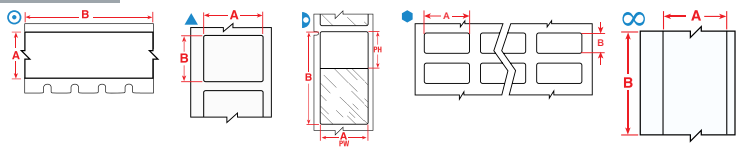

Labels are shown in order of label width.

The background colours in the Order Reference column represent the material colour.

See page 58 for Brady's range of label printers.

| Diagram | Material | Special Properties | Label Width A (mm) | Label Height B (mm) | Label Length B (m) | Printable Area Width PW (mm) | Printable Area Height PH (mm) | Order Reference    | Printer Compatibility | Printer Ribbon Series | Labels per Roll | Labels per Row |
|---------|----------|--------------------|--------------------|---------------------|--------------------|------------------------------|-------------------------------|--------------------|-----------------------|-----------------------|-----------------|----------------|
| ▲       | B-490    | <b>F N H L</b>     | 38.10              | 55.88               | -                  | -                            | -                             | M6-113-490         | M610, M611            | R4300                 | 100             | 1              |
| ▲       | B-490    | <b>F N H L</b>     | 38.10              | 98.43               | -                  | -                            | -                             | M6-114-490         | M610, M611            | R4300                 | 100             | 1              |
| ▲       | B-499    | <b>F N A</b>       | 38.10              | 101.60              | -                  | -                            | -                             | B33-327-499        | i3300, i5300          | B30 Monocolour        | 450             | 2              |
| ●       | B-498    | <b>F</b>           | 38.10              | 101.60              | -                  | -                            | -                             | B33-327-498        | i3300, i5300          | B30 Monocolour        | 450             | 2              |
| ●       | B-499    | <b>F N A</b>       | 38.10              | 152.40              | -                  | -                            | -                             | B33-328-499        | i3300, i5300          | B30 Monocolour        | 300             | 2              |
| ●       | B-498    | <b>F</b>           | 38.10              | 152.40              | -                  | -                            | -                             | B33-328-498        | i3300, i5300          | B30 Monocolour        | 300             | 2              |
| ▷       | B-461    | <b>F N A H S L</b> | 41.91              | 12.70               | -                  | 19.05                        | 12.70                         | M6-202-461         | M610, M611            | R4300, R6200          | 500             | 1              |
| ▷       | B-461    | <b>F N A H S L</b> | 44.45              | 25.40               | -                  | 25.40                        | 25.40                         | M6-203-461         | M610, M611            | R4300, R6200          | 100             | 1              |
| ▷       | B-461    | <b>F N A H S L</b> | 45.72              | 15.24               | -                  | 25.40                        | 15.24                         | M6-201-461         | M610, M611            | R4300, R6200          | 100             | 1              |
| ▲       | B-488    | <b>F A</b>         | 48.26              | 6.35                | -                  | -                            | -                             | B33-635-488        | i3300                 | B30-R4300             | 2000            | 1              |
| ▲       | B-498    | <b>F</b>           | 48.26              | 25.40               | -                  | -                            | -                             | M-128-498          | BMP41, BMP51          | R6200                 | 100             | -              |
| ▲       | B-499    | <b>F N A</b>       | 48.26              | 25.40               | -                  | -                            | -                             | M6-78-499          | M610, M611            | R4300, R6000HF, R6200 | 250             | 1              |
| ▲       | B-488    | <b>F A</b>         | 48.26              | 25.40               | -                  | -                            | -                             | M6-78-488          | M610, M611            | R4300                 | 250             | 1              |
| ▲       | B-427    | <b>F N</b>         | 48.26              | 25.40               | -                  | -                            | -                             | M6-78-427-AW**     | M610, M611            | R4300                 | 250             | 1              |
| ▲       | B-499    | <b>F N A</b>       | 48.26              | 25.40               | -                  | -                            | -                             | M7-78-499          | M710                  | R4300                 | 250             | 1              |
| ⊙       | B-499    | <b>F N A</b>       | 48.26              | -                   | 9.14               | -                            | -                             | M7C-1900-499       | M710                  | R4300, R6000HF, R6200 | 1               | 1              |
| ▲       | B-499    | <b>F N A</b>       | 50.80              | 6.35                | -                  | -                            | -                             | B33-151-499        | i3300                 | B30 Monocolour        | 1500            | 1              |
| ▲       | B-499    | <b>F N A</b>       | 50.80              | 6.35                | -                  | -                            | -                             | THT-151-499-3      | BBP12, i7100, i5100   | R4900                 | 3000            | 1              |
| ▲       | B-499    | <b>F N A</b>       | 50.80              | 6.35                | -                  | -                            | -                             | THT-151-499-1.5-SC | BBP12                 | R7950, R4300, R4900   | 1500            | 1              |
| ▲       | B-488    | <b>F A</b>         | 50.80              | 6.35                | -                  | -                            | -                             | THT-15-488-2.5     | BBP12, i7100, i5100   | R4300, R7950          | 2500            | 1              |
| ▲       | B-7425J  | <b>F N A H</b>     | 50.80              | 12.70               | -                  | -                            | -                             | J20-53-7425J       | J2000                 |                       | 2000            | 1              |
| ▲       | B-499    | <b>F N A</b>       | 50.80              | 19.05               | -                  | -                            | -                             | M21-137-499        | M210, M210-LAB, M211  | R4300                 | 1               | 1              |
| ▲       | B-423    | <b>F A H</b>       | 50.80              | 19.05               | -                  | -                            | -                             | M21-137-423        | M210, M210-LAB, M211  | R6000HF               | 1               | 1              |
| ▲       | B-499    | <b>F N A</b>       | 50.80              | 25.40               | -                  | -                            | -                             | B33-137-499        | i3300                 | B30 Monocolour        | 1100            | 1              |
| ▲       | B-432    | <b>F A</b>         | 50.80              | 25.40               | -                  | -                            | -                             | B33-17-432         | i3300                 | B30 Monocolour        | 1500            | 1              |
| ▲       | B-430    | <b>F A H</b>       | 50.80              | 25.40               | -                  | -                            | -                             | B33-17-430         | i3300                 | B30 Monocolour        | 1500            | 1              |
| ▲       | B-425A   | <b>F</b>           | 50.80              | 25.40               | -                  | -                            | -                             | B33-17-425         | i3300                 | B30 Monocolour        | 1500            | 1              |
| ▲       | B-423    | <b>F A H</b>       | 50.80              | 25.40               | -                  | -                            | -                             | B33-17-423         | i3300                 | B30 Monocolour        | 1500            | 1              |
| ▲       | B-423    | <b>F A H</b>       | 50.80              | 25.40               | -                  | -                            | -                             | BM-20-423          | M610, M611, M710      | R6000HF               | 1000            | 1              |
| ▲       | B-8423   | <b>F A</b>         | 50.80              | 25.40               | -                  | -                            | -                             | BPT-17-8423-1      | BBP12                 | R6000HF               | 1000            | 1              |
| ▲       | B-533    | <b>F A</b>         | 50.80              | 25.40               | -                  | -                            | -                             | THT-17-533-3       | BBP12, i7100, i5100   | R6000HF               | 3000            | 1              |
| ▲       | B-498    | <b>F</b>           | 50.80              | 25.40               | -                  | -                            | -                             | THT-17-498-3       | BBP12, i7100, i5100   | R4300, R7950          | 3000            | 1              |
| ▲       | B-498    | <b>F</b>           | 50.80              | 25.40               | -                  | -                            | -                             | THT-17-498-1.5-SC  | BBP12                 | R7950                 | 1500            | 1              |
| ▲       | B-430    | <b>F A H</b>       | 50.80              | 25.40               | -                  | -                            | -                             | THT-17-430-3       | BBP12, i7100, i5100   | R6000HF               | 3000            | 1              |
| ▲       | B-425A   | <b>F</b>           | 50.80              | 25.40               | -                  | -                            | -                             | THT-17-425-3       | BBP12, i7100, i5100   | R6400                 | 3000            | 1              |
| ▲       | B-423    | <b>F A H</b>       | 50.80              | 25.40               | -                  | -                            | -                             | THT-17-423-3       | BBP12, i7100, i5100   | R6000HF               | 3000            | 1              |
| ⊙       | B-430    | <b>F A H</b>       | 50.80              | -                   | 15.24              | -                            | -                             | M7C-1900-430       | M710                  | R6000HF               | 1               | 1              |
| ▲       | B-7425J  | <b>F N A H</b>     | 55.12              | 85.00               | -                  | -                            | -                             | J20-260-7425J      | J2000                 |                       | 340             | 1              |
| ▲       | B-7425J  | <b>F N A H</b>     | 55.12              | 85.00               | -                  | -                            | -                             | J40-260-7425J      | J4000                 |                       | 340             | 1              |
| ∞       | B-7425J  | <b>F N A H</b>     | 57.15              | -                   | 30.48              | -                            | -                             | J40C-2250-7425J    | J4000                 |                       | 1               | 1              |
| ▷       | B-461    | <b>F N A H S L</b> | 63.50              | 38.10               | -                  | 19.05                        | 38.10                         | M6-157-461         | M610, M611            | R4300                 | 100             | 1              |
| ▲       | B-8423   | <b>F A</b>         | 69.85              | 31.75               | -                  | -                            | -                             | BPT-7-8423-1       | BBP12                 | R6000HF               | 1000            | 1              |
| ▲       | B-423    | <b>F A H</b>       | 69.85              | 31.75               | -                  | -                            | -                             | M7-26-423          | M710                  | R6000HF               | 100             | 1              |
| ▲       | B-7425J  | <b>F N A H</b>     | 74.93              | 109.98              | -                  | -                            | -                             | J20-261-7425J      | J2000                 |                       | 270             | 1              |
| ▲       | B-432    | <b>F A</b>         | 76.20              | 25.40               | -                  | -                            | -                             | B33-18-432         | i3300                 | B30 Monocolour        | 1500            | 1              |
| ▲       | B-430    | <b>F A H</b>       | 76.20              | 25.40               | -                  | -                            | -                             | B33-18-430         | i3300                 | B30 Monocolour        | 1500            | 1              |
| ▲       | B-423    | <b>F A H</b>       | 76.20              | 25.40               | -                  | -                            | -                             | B33-18-423         | i3300                 | B30 Monocolour        | 1500            | 1              |
| ▲       | B-423    | <b>F A</b>         | 76.20              | 25.40               | -                  | -                            | -                             | M6-22-423          | M610, M611            | R6000HF               | 100             | 1              |
| ▲       | B-423    | <b>F A H</b>       | 76.20              | 25.40               | -                  | -                            | -                             | M7-22-423          | M710                  | R6000HF               | 100             | 1              |
| ▲       | B-423    | <b>F A H</b>       | 76.20              | 25.40               | -                  | -                            | -                             | THT-18-423-3       | BBP12, i7100, i5100   | R6000HF               | 3000            | 1              |
| ▲       | B-351    | <b>F</b>           | 76.20              | 48.26               | -                  | -                            | -                             | M6-37-351          | M611, M610, M710      | R6200, R6000HF        | 100             | 1              |
| ▲       | B-432    | <b>F A</b>         | 76.20              | 50.80               | -                  | -                            | -                             | B33-19-432         | i3300                 | B30 Monocolour        | 500             | 1              |
| ▲       | B-432    | <b>F A</b>         | 76.20              | 50.80               | -                  | -                            | -                             | THT-19-432-1       | BBP12, i7100, i5100   | R6000HF               | 1000            | 1              |
| ▷       | B-461    | <b>F N A H S L</b> | 88.90              | 38.10               | -                  | 25.40                        | 15.24                         | M6-77-461          | M610, M611            | R4300                 | 100             | 1              |
| ▲       | B-490    | <b>F N H L</b>     | 95.25              | 38.10               | -                  | -                            | -                             | THT-158-490-3      | BBP12, i7100, i5100   | R4300, R7950          | 3000            | 1              |

>>

# Bottles / Flasks & Dishes

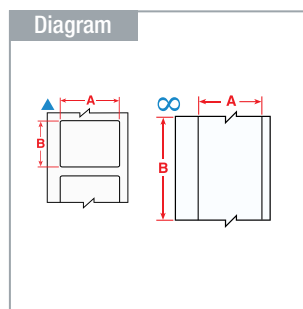

Labels are shown in order of label width.

The background colours in the Order Reference column represent the material colour.

See page 58 for Brady's range of label printers.

| Diagram | Material | Special Properties | Label Width A (mm) | Label Height B (mm) | Label Length B (m) | Printable Area Width PW (mm) | Printable Area Height PH (mm) | Order Reference    | Printer Compatibility | Printer Ribbon Series | Labels per Roll | Labels per Row |
|---------|----------|--------------------|--------------------|---------------------|--------------------|------------------------------|-------------------------------|--------------------|-----------------------|-----------------------|-----------------|----------------|
| ▲       | B-490    | <b>F N H L</b>     | 95.25              | 38.10               | -                  | -                            | -                             | THT-158-490-1.5-SC | BBP12                 | R7950                 | 1500            | 1              |
| ∞       | B-7425J  | <b>F N A H</b>     | 101.60             | -                   | 30.48              | -                            | -                             | J40C-4000-7425J    | J4000                 |                       | 1               | 1              |
| ▲       | B-7425J  | <b>F N A H</b>     | 104.90             | 154.94              | -                  | -                            | -                             | J20-262-7425J      | J2000                 |                       | 200             | 1              |
| ▲       | B-7425J  | <b>F N A H</b>     | 104.90             | 154.94              | -                  | -                            | -                             | J40-262-7425J      | J4000                 |                       | 200             | 1              |
| ∞       | B-7425J  | <b>F N A H</b>     | 152.40             | -                   | 30.48              | -                            | -                             | J40C-6000-7425J    | J4000                 |                       | 1               | 1              |
| ▲       | B-7425J  | <b>F N A H</b>     | 177.80             | 254.00              | -                  | -                            | -                             | J40-265-7425J      | J4000                 |                       | 100             | 1              |
| ▲       | B-7425J  | <b>F N A H</b>     | 203.20             | 133.35              | -                  | -                            | -                             | J40-321-2475J      | J4000                 |                       | 100             | 1              |
| ▲       | B-7425J  | <b>F N A H</b>     | 203.20             | 279.40              | -                  | -                            | -                             | J40-268-2475J      | J4000                 |                       | 100             | 1              |
| ∞       | B-7425J  | <b>F N A H</b>     | 203.20             | -                   | 30.48              | -                            | -                             | J40C-8000-7425J    | J4000                 |                       | 1               | 1              |



## Bottle Tamper Seal Labels

Brady's bottle seal identification provides tracking information with the added feature of security. These labelling materials are designed to fracture easily in order to show signs of sample tampering and to prevent one-piece label removal.

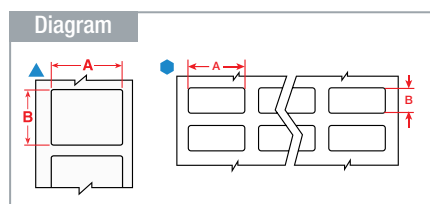

| Diagram | Material | Special Properties | Label Width A (mm) | Label Height B (mm) | Order Reference | Printer Compatibility | Printer Ribbon Series | Labels per Roll | Labels per Row |
|---------|----------|--------------------|--------------------|---------------------|-----------------|-----------------------|-----------------------|-----------------|----------------|
| ◆       | B-7351   | <b>F</b>           | 25.40              | 12.70               | THT-5-7351-10   | BBP12, i7100, i5100   | R6000HF               | 10000           | 3              |
| ▲       | B-351    | <b>F</b>           | 25.40              | 12.70               | M-17-351        | BMP51                 | R6000HF               | 360             | 1              |
| ▲       | B-351    | <b>F</b>           | 25.40              | 12.70               | M7-17-351       | M710                  | R6000HF               | 500             | 1              |
| ▲       | B-351    | <b>F</b>           | 25.40              | 50.80               | M-20-351        | BMP51                 | R6000HF               | 160             | 1              |
| ▲       | B-351    | <b>F</b>           | 25.40              | 50.80               | M7-20-351       | M710                  | R6000HF               | 100             | 1              |
| ▲       | B-351    | <b>F</b>           | 38.10              | 25.40               | M7-31-351       | M710                  | R6000HF               | 250             | 1              |
| ▲       | B-7351   | <b>F</b>           | 50.80              | 25.40               | THT-17-7351-3   | BBP12, i7100, i5100   | R6000HF               | 3000            | 1              |
| ▲       | B-351    | <b>F</b>           | 76.20              | 48.26               | M7-37-351       | M710                  | R6000HF               | 100             | 1              |

**F** Freezer environment **N** Liquid nitrogen environment **A** Autoclave environment **H** Hot water bath (100°C) **S** Self-laminating label **L** Low-profile (extremely thin) label **R** Removable

## B-403 Water dissolvable label

The B-403 water dissolvable paper is self-adhesive and extremely easy to apply. Exposing the label to warm water will completely dissolve it within 30 seconds, without damage to the surface it was applied to, and without leaving any residue. The water dissolvable label adheres well to most surfaces, including glass, stainless steel, aluminium, plastic and others. This makes the label a great solution to enable short term identification for containers, crates and glassware with a minimum of waste.

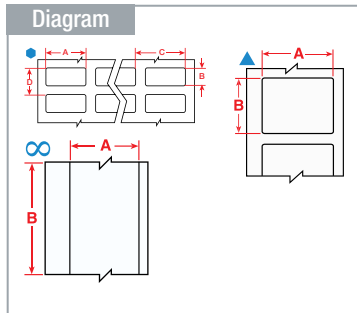

- F** Freezer environment
- A** Autoclave environment
- H** Hot water bath (100°C)
- S** Self-laminating label
- L** Low-profile (extremely thin) label
- R** Removable

Labels are shown in order of label width.

The background colours in the Order Reference column represent the material colour.

See page 58 for Brady's range of label printers.

| Diagram | Material | Special Properties | Label Width A (mm) | Label Height B (mm) | Label Length B (m) | Order Reference  | Printer Compatibility | Printer Ribbon Series | Labels per Roll | Labels per Row |
|---------|----------|--------------------|--------------------|---------------------|--------------------|------------------|-----------------------|-----------------------|-----------------|----------------|
| ⊙       | B-403    | <b>R</b>           | 12.70              | –                   | 7.62               | M21-500-403      | M210, M210-LAB, M211  | R4300                 | 1               | –              |
| ●       | B-403    | <b>R</b>           | 22.86              | 22.86               | –                  | THT-141-403-3    | BBP12, i7100, i5100   | R4300                 | 3000            | 2              |
| ∞       | B-403    | <b>R</b>           | 28.58              | –                   | 30.48              | B30C-1125-403-WT | i3300                 | B30-R4300             | 1               | 1              |
| ∞       | B-403    | <b>R</b>           | 28.58              | –                   | 30.48              | J20C-1125-403    | J2000                 | –                     | 1               | 1              |
| ∞       | B-403    | <b>R</b>           | 28.58              | –                   | 91.44              | THT-1125-403-WT  | BBP12, i7100, i5100   | R4300                 | 1               | 1              |
| ▲       | B-403    | <b>R</b>           | 38.10              | 19.05               | –                  | THT-136-403-3    | BBP12, i7100, i5100   | R4300                 | 3000            | 1              |
| ▲       | B-403    | <b>R</b>           | 50.80              | 25.40               | –                  | J20-17-403       | J2000                 | –                     | 1500            | 1              |
| ▲       | B-403    | <b>R</b>           | 50.80              | 25.40               | –                  | THT-17-403-3     | BBP12, i7100, i5100   | R4300                 | 3000            | 1              |
| ∞       | B-403    | <b>R</b>           | 57.15              | –                   | 30.48              | B30C-2250-403-WT | i3300                 | B30-R4300             | 1               | 1              |
| ∞       | B-403    | <b>R</b>           | 57.15              | –                   | 30.48              | J20C-2250-403    | J2000                 | –                     | 1               | 1              |
| ∞       | B-403    | <b>R</b>           | 57.15              | –                   | 91.44              | THT-2250-403-WT  | BBP12, i7100, i5100   | R4300                 | 1               | 1              |
| ▲       | B-403    | <b>R</b>           | 76.20              | 25.40               | –                  | THT-18-403-3     | BBP12, i7100, i5100   | R4300                 | 3000            | 1              |
| ▲       | B-403    | <b>R</b>           | 76.20              | 50.80               | –                  | J20-19-403       | J2000                 | –                     | 350             | 1              |
| ▲       | B-403    | <b>R</b>           | 76.20              | 50.80               | –                  | THT-19-403-1     | BBP12, i7100, i5100   | R4300                 | 1000            | 1              |
| ∞       | B-403    | <b>R</b>           | 76.20              | –                   | 30.48              | B30C-3000-403-WT | i3300                 | B30-R4300             | 1               | 1              |
| ∞       | B-403    | <b>R</b>           | 76.20              | –                   | 91.44              | THT-3000-403-WT  | BBP12, i7100, i5100   | R4300                 | 1               | 1              |
| ▲       | B-403    | <b>R</b>           | 101.60             | 50.80               | –                  | J20-55-403       | J2000                 | –                     | 250             | 1              |
| ▲       | B-403    | <b>R</b>           | 101.60             | 50.80               | –                  | THT-55-403-1     | BBP12, i7100, i5100   | R4300                 | 1000            | 1              |
| ∞       | B-403    | <b>R</b>           | 101.60             | –                   | 30.48              | B30C-4000-403-WT | i3300                 | B30-R4300             | 1               | 1              |
| ∞       | B-403    | <b>R</b>           | 101.60             | –                   | 91.44              | THT-4000-403-WT  | BBP12, i7100, i5100   | R4300                 | 1               | 1              |

## B-7425-AC Sterilisation indicating label

Sterilisation indicating labels provide users with proof of sterilisation. They are ideal for a broad range of laboratory processes including sample tracking, inventory management, general tracking, and glassware or tray identification.

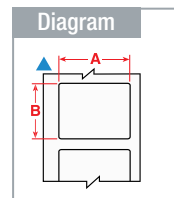

| Diagram | Material | Label Width A (mm) | Label Height B (mm) | Order Reference   | Printer Compatibility | Printer Ribbon Series | Labels per Roll | Labels per Row |
|---------|----------|--------------------|---------------------|-------------------|-----------------------|-----------------------|-----------------|----------------|
| ▲       | B-7425   | 38.10              | 25.40               | B33-235-7425-AC   | i3300                 | B30 Monocolour        | 1250            | 1              |
| ▲       | B-7425   | 38.10              | 25.40               | THT-235-7425-2-AC | BBP12, i7100, i5100   | R4300                 | 2000            | 1              |
| ▲       | B-7425   | 50.80              | 25.40               | B33-137-7425-AC   | i3300                 | B30 Monocolour        | 1500            | 1              |
| ▲       | B-7425   | 50.80              | 25.40               | THT-137-7425-2-AC | BBP12, i7100, i5100   | R4300                 | 2000            | 1              |



## General Lab ID

Just like a durable sample label lets you know which sample you are holding, a cabinet or drawer label can inform you of the cabinet's content. With proper identification, time spent looking for the right sample or tool can be invested in what really matters. Brady offers a range of materials suitable for identifying drawers, cabinets, shelves, storage units and laboratory equipment.

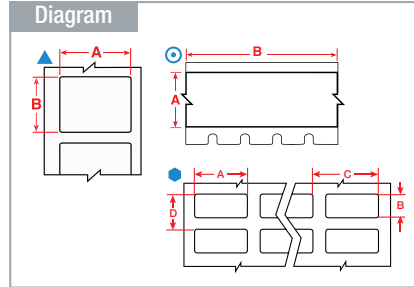

- F** Freezer environment
- N** Liquid nitrogen environment
- A** Autoclave environment
- H** Hot water bath (100°C)
- S** Self-laminating label
- L** Low-profile (extremely thin) label
- R** Removable

Labels are shown in order of label width.

The background colours in the Order Reference column represent the material colour.

See page 58 for Brady's range of label printers.

| Diagram | Material | Special Properties | Label Width A (mm) | Label Height B (mm) | Label Length B (m) | Order Reference   | Printer Compatibility | Printer Ribbon Series | Labels per Roll | Labels per Row |
|---------|----------|--------------------|--------------------|---------------------|--------------------|-------------------|-----------------------|-----------------------|-----------------|----------------|
| ●       | B-499    | <b>F N A</b>       | 6.35               | 36.50               | –                  | B33-90-499        | i3300, i5300          | B30 Monocolour        | 2500            | 6              |
| ○       | B-595    | <b>F</b>           | 6.35               | –                   | 6.40               | M21-250-595-WT    | M210-LAB, M211        | R6000HF               | 1               | –              |
| ○       | B-595    | <b>F</b>           | 6.35               | –                   | 6.40               | M21-250-595-YL    | M210-LAB, M211        | R6000HF               | 1               | –              |
| ○       | B-430    | <b>F A H</b>       | 6.35               | –                   | 6.40               | M21-250-430-WT-CL | M210-LAB, M211        | R6200                 | 1               | –              |
| ○       | B-423    | <b>F A H</b>       | 6.35               | –                   | 6.40               | M21-250-423       | M210-LAB, M211        | R6200                 | 1               | –              |
| ○       | B-430    | <b>F A H</b>       | 6.35               | –                   | 6.40               | M21-250-430       | M210-LAB, M211        | R6200                 | 1               | –              |
| ▲       | B-499    | <b>F N A</b>       | 9.53               | 20.96               | –                  | M-130-499         | BMP41, BMP51          | R4300                 | 220             | –              |
| ○       | B-499    | <b>F N A</b>       | 9.53               | –                   | 4.88               | M21-375-499       | M210-LAB, M211        | R4300                 | 1               | –              |
| ○       | B-499    | <b>F N A</b>       | 9.53               | –                   | 4.88               | MC-375-499        | BMP41, BMP51          | R4300                 | 1               | –              |
| ○       | B-423    | <b>F A H</b>       | 9.53               | –                   | 6.40               | M21-375-423       | M210-LAB, M211        | R6200                 | 1               | –              |
| ○       | B-430    | <b>F A H</b>       | 9.53               | –                   | 6.40               | M21-375-430       | M210-LAB, M211        | R6200                 | 1               | –              |
| ○       | B-488    | <b>F A</b>         | 9.53               | –                   | 6.40               | M21-375-488       | M210-LAB, M211        | R4300                 | 1               | –              |
| ○       | B-595    | <b>F</b>           | 9.53               | –                   | 6.40               | M21-375-595-PL    | M210-LAB, M211        | R4400                 | 1               | –              |
| ○       | B-595    | <b>F</b>           | 9.53               | –                   | 6.40               | M21-375-595-BR    | M210-LAB, M211        | R4400                 | 1               | –              |
| ○       | B-595    | <b>F</b>           | 9.53               | –                   | 6.40               | M21-375-595-GY    | M210-LAB, M211        | R6000HF               | 1               | –              |
| ○       | B-595    | <b>F</b>           | 9.53               | –                   | 6.40               | M21-375-595-BK    | M210-LAB, M211        | R4400                 | 1               | –              |
| ○       | B-430    | <b>F A H</b>       | 9.53               | –                   | 6.40               | M21-375-430-WT-CL | M210-LAB, M211        | R6200                 | 1               | –              |
| ○       | B-595    | <b>F</b>           | 9.53               | –                   | 6.40               | M21-375-595-WT    | M210-LAB, M211        | R6000HF               | 1               | –              |
| ○       | B-595    | <b>F</b>           | 9.53               | –                   | 6.40               | M21-375-595-GN    | M210-LAB, M211        | R4400                 | 1               | –              |
| ○       | B-595    | <b>F</b>           | 9.53               | –                   | 6.40               | M21-375-595-YL    | M210-LAB, M211        | R6000HF               | 1               | –              |
| ○       | B-595    | <b>F</b>           | 9.53               | –                   | 6.40               | M21-375-595-BL    | M210-LAB, M211        | R4400                 | 1               | –              |
| ○       | B-595    | <b>F</b>           | 9.53               | –                   | 6.40               | M21-375-595-OR    | M210-LAB, M211        | R6000HF               | 1               | –              |
| ○       | B-595    | <b>F</b>           | 9.53               | –                   | 6.40               | M21-375-595-RD    | M210-LAB, M211        | R4400                 | 1               | –              |
| ○       | B-595    | <b>F</b>           | 9.53               | –                   | 7.62               | MC-375-595-WT-BK  | BMP41, BMP51          | R6000HF               | 1               | –              |
| ○       | B-595    | <b>F</b>           | 9.53               | –                   | 7.62               | MC-375-595-YL-BK  | BMP41, BMP51          | R6000HF               | 1               | –              |
| ○       | B-595    | <b>F</b>           | 9.53               | –                   | 7.62               | MC-375-595-RD-WT  | BMP41, BMP51          | R4400                 | 1               | –              |
| ○       | B-430    | <b>F A H</b>       | 9.53               | –                   | 15.24              | M7C-375-430       | M710                  | R6000HF               | 1               | 1              |
| ▲       | B-498    | <b>F</b>           | 12.70              | 25.40               | –                  | M-131-498         | BMP41, BMP51          | R6200                 | 180             | –              |
| ▲       | B-499    | <b>F N A</b>       | 12.70              | 25.40               | –                  | M-131-499         | BMP41, BMP51          | R4300                 | 180             | –              |
| ●       | B-499    | <b>F N A</b>       | 12.70              | 36.50               | –                  | B33-87-499        | i3300, i5300          | B30 Monocolour        | 2500            | 6              |
| ▲       | B-490    | <b>F N H L</b>     | 12.70              | 41.91               | –                  | M6-124-490        | M610, M611            | R4300                 | 500             | 1              |
| ○       | B-499    | <b>F N A</b>       | 12.70              | –                   | 4.88               | M21-500-499       | M210-LAB, M211        | R4300                 | 1               | –              |
| ○       | B-499    | <b>F N A</b>       | 12.70              | –                   | 4.88               | MC-500-499        | BMP41, BMP51          | R4300                 | 1               | –              |
| ○       | B-595    | <b>F</b>           | 12.70              | –                   | 6.10               | MC-500-595-CL-BK  | BMP41, BMP51          | R6000HF               | 1               | –              |
| ○       | B-595    | <b>F</b>           | 12.70              | –                   | 6.10               | MC-500-595-CL-WT  | BMP41, BMP51          | R4400                 | 1               | –              |
| ○       | B-423    | <b>F A H</b>       | 12.70              | –                   | 6.40               | M21-500-423       | M210-LAB, M211        | R6200                 | 1               | –              |
| ○       | B-430    | <b>F A H</b>       | 12.70              | –                   | 6.40               | M21-500-430       | M210-LAB, M211        | R6200                 | 1               | –              |
| ○       | B-488    | <b>F A</b>         | 12.70              | –                   | 6.40               | M21-500-488       | M210-LAB, M211        | R4300                 | 1               | –              |
| ○       | B-595    | <b>F</b>           | 12.70              | –                   | 6.40               | M21-500-595-PL    | M210-LAB, M211        | R4400                 | 1               | –              |
| ○       | B-595    | <b>F</b>           | 12.70              | –                   | 6.40               | M21-500-595-BR    | M210-LAB, M211        | R4400                 | 1               | –              |
| ○       | B-595    | <b>F</b>           | 12.70              | –                   | 6.40               | M21-500-595-GY    | M210-LAB, M211        | R6000HF               | 1               | –              |
| ○       | B-595    | <b>F</b>           | 12.70              | –                   | 6.40               | M21-500-595-BK    | M210-LAB, M211        | R4400                 | 1               | –              |
| ○       | B-430    | <b>F A H</b>       | 12.70              | –                   | 6.40               | M21-500-430-WT-CL | M210-LAB, M211        | R6200                 | 1               | –              |
| ○       | B-595    | <b>F</b>           | 12.70              | –                   | 6.40               | M21-500-595-RD    | M210-LAB, M211        | R4400                 | 1               | –              |
| ○       | B-595    | <b>F</b>           | 12.70              | –                   | 6.40               | M21-500-595-OR    | M210-LAB, M211        | R6000HF               | 1               | –              |

>>

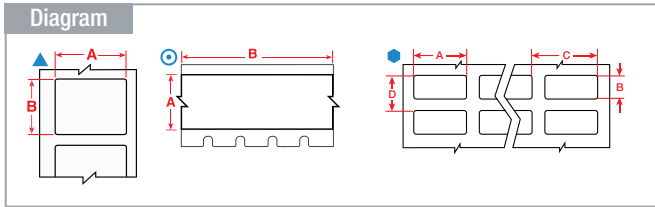

Labels are shown in order of label width.

The background colours in the Order Reference column represent the material colour.

See page 58 for Brady's range of printers.

| Diagram | Material | Special Properties | Label Width A (mm) | Label Height B (mm) | Label Length B (m) | Order Reference   | Printer Compatibility | Printer Ribbon Series | Labels per Roll | Labels per Row |
|---------|----------|--------------------|--------------------|---------------------|--------------------|-------------------|-----------------------|-----------------------|-----------------|----------------|
| ⊙       | B-595    | F                  | 12.70              | —                   | 6.40               | M21-500-595-BL    | M210-LAB, M211        | R4400                 | 1               | —              |
| ⊙       | B-595    | F                  | 12.70              | —                   | 6.40               | M21-500-595-YL    | M210-LAB, M211        | R6000HF               | 1               | —              |
| ⊙       | B-595    | F                  | 12.70              | —                   | 6.40               | M21-500-595-GN    | M210-LAB, M211        | R4400                 | 1               | —              |
| ⊙       | B-595    | F                  | 12.70              | —                   | 6.40               | M21-500-595-WT    | M210-LAB, M211        | R6000HF               | 1               | —              |
| ⊙       | B-595    | F                  | 12.70              | —                   | 7.62               | MC-500-595-OR-BK  | BMP41, BMP51          | R6000HF               | 1               | —              |
| ⊙       | B-595    | F                  | 12.70              | —                   | 7.62               | MC-500-595-WT-BK  | BMP41, BMP51          | R6000HF               | 1               | —              |
| ⊙       | B-595    | F                  | 12.70              | —                   | 7.62               | MC-500-595-YL-BK  | BMP41, BMP51          | R6000HF               | 1               | —              |
| ⊙       | B-595    | F                  | 12.70              | —                   | 7.62               | MC-500-595-WT-RD  | BMP41, BMP51          | R4400                 | 1               | —              |
| ⊙       | B-595    | F                  | 12.70              | —                   | 7.62               | MC-500-595-BK-WT  | BMP41, BMP51          | R4400                 | 1               | —              |
| ⊙       | B-595    | F                  | 12.70              | —                   | 7.62               | MC-500-595-BL-WT  | BMP41, BMP51          | R4400                 | 1               | —              |
| ⊙       | B-595    | F                  | 12.70              | —                   | 7.62               | MC-500-595-GN-WT  | BMP41, BMP51          | R4400                 | 1               | —              |
| ⊙       | B-595    | F                  | 12.70              | —                   | 7.62               | MC-500-595-RD-WT  | BMP41, BMP51          | R4400                 | 1               | —              |
| ⊙       | B-499    | F N A              | 12.70              | —                   | 9.14               | M7C-500-499       | M710                  | R4300, R6000HF, R6200 | 1               | 1              |
| ⊙       | B-595    | F                  | 12.70              | —                   | 15.24              | M7C-500-595-YL    | M710                  | R6000HF, R4400-WT     | 1               | 1              |
| ⊙       | B-595    | F                  | 12.70              | —                   | 15.24              | M7C-500-595-WT    | M710                  | R6000HF               | 1               | 1              |
| ⊙       | B-595    | F                  | 12.70              | —                   | 15.24              | M7C-500-595-RD    | M710                  | R6000HF, R4400-WT     | 1               | 1              |
| ⊙       | B-595    | F                  | 12.70              | —                   | 15.24              | M7C-500-595-OR    | M710                  | R6000HF, R4400-WT     | 1               | 1              |
| ⊙       | B-595    | F                  | 12.70              | —                   | 15.24              | M7C-500-595-GN    | M710                  | R6000HF, R4400-WT     | 1               | 1              |
| ⊙       | B-595    | F                  | 12.70              | —                   | 15.24              | M7C-500-595-CL    | M710                  | R6000HF, R4400-WT     | 1               | 1              |
| ⊙       | B-595    | F                  | 12.70              | —                   | 15.24              | M7C-500-595-BL    | M710                  | R6000HF, R4400-WT     | 1               | 1              |
| ⊙       | B-595    | F                  | 12.70              | —                   | 15.24              | M7C-500-595-BK    | M710                  | R4400-WT              | 1               | 1              |
| ⊙       | B-430    | F A H              | 12.70              | —                   | 15.24              | M7C-500-430       | M710                  | R6000HF               | 1               | 1              |
| ⊙       | B-492    | F N H L            | 12.70              | —                   | 15.24              | M6C-500-492       | M610, M611            | R4300, R6400          | 1               | 1              |
| ∞       | B-595    | F                  | 12.70              | —                   | 30.48              | B30C-500-595-BK   | i3300                 | B30-R10000-WT         | 1               | 1              |
| ∞       | B-595    | F                  | 12.70              | —                   | 30.48              | B30C-500-595-BL   | i3300                 | B30-R10000-WT         | 1               | 1              |
| ∞       | B-595    | F                  | 12.70              | —                   | 30.48              | B30C-500-595-CL   | i3300                 | B30-R10000            | 1               | 1              |
| ∞       | B-595    | F                  | 12.70              | —                   | 30.48              | B30C-500-595-GN   | i3300                 | B30-R10000-WT         | 1               | 1              |
| ∞       | B-595    | F                  | 12.70              | —                   | 30.48              | B30C-500-595-OR   | i3300                 | B30-R10000            | 1               | 1              |
| ∞       | B-595    | F                  | 12.70              | —                   | 30.48              | B30C-500-595-RD   | i3300                 | B30-R10000-WT         | 1               | 1              |
| ∞       | B-595    | F                  | 12.70              | —                   | 30.48              | B30C-500-595-WT   | i3300                 | B30-R10000            | 1               | 1              |
| ∞       | B-595    | F                  | 12.70              | —                   | 30.48              | B30C-500-595-YL   | i3300                 | B30-R10000            | 1               | 1              |
| ▲       | B-490    | F N H L            | 15.24              | 45.72               | —                  | M6-126-490        | M610, M611            | R4300                 | 250             | 1              |
| ●       | B-499    | F N A              | 19.05              | 6.35                | —                  | B33-1-499         | i3300, i5300          | B30 Monocolour        | 10000           | 4              |
| ▲       | B-499    | F N A              | 19.05              | 12.70               | —                  | M21-11-499        | M210-LAB, M211        | R4300                 | 1               | 1              |
| ▲       | B-423    | F A H              | 19.05              | 12.70               | —                  | M21-7-423         | M210-LAB, M211        | R6000HF               | 1               | 1              |
| ▲       | B-498    | F R                | 19.05              | 19.05               | —                  | B33-254-498       | i3300, i5300          | B30 Monocolour        | 1000            | 1              |
| ▲       | B-499    | F N A              | 19.05              | 19.05               | —                  | B33-254-499       | i3300, i5300          | B30 Monocolour        | 1000            | 1              |
| ●       | B-499    | F N A              | 19.05              | 23.80               | —                  | B33-91-499        | i3300, i5300          | B30 Monocolour        | 2500            | 4              |
| ⊙       | B-499    | F N A              | 19.05              | —                   | 4.88               | M21-750-499       | M210-LAB, M211        | R4300                 | 1               | —              |
| ⊙       | B-499    | F N A              | 19.05              | —                   | 4.88               | MC-750-499        | BMP41, BMP51          | R4300                 | 1               | —              |
| ⊙       | B-595    | F                  | 19.05              | —                   | 6.10               | MC-750-595-CL-BK  | BMP41, BMP51          | R6000HF               | 1               | —              |
| ⊙       | B-595    | F                  | 19.05              | —                   | 6.10               | MC-750-595-CL-WT  | BMP41, BMP51          | R4400                 | 1               | —              |
| ⊙       | B-423    | F A H              | 19.05              | —                   | 6.40               | M21-750-423       | M210-LAB, M211        | R6200                 | 1               | —              |
| ⊙       | B-430    | F A H              | 19.05              | —                   | 6.40               | M21-750-430       | M210-LAB, M211        | R6200                 | 1               | —              |
| ⊙       | B-488    | F A                | 19.05              | —                   | 6.40               | M21-750-488       | M210-LAB, M211        | R4300                 | 1               | —              |
| ⊙       | B-595    | F                  | 19.05              | —                   | 6.40               | M21-750-595-PL    | M210-LAB, M211        | R4400                 | 1               | —              |
| ⊙       | B-595    | F                  | 19.05              | —                   | 6.40               | M21-750-595-BR    | M210-LAB, M211        | R4400                 | 1               | —              |
| ⊙       | B-595    | F                  | 19.05              | —                   | 6.40               | M21-750-595-GY    | M210-LAB, M211        | R6000HF               | 1               | —              |
| ⊙       | B-595    | F                  | 19.05              | —                   | 6.40               | M21-750-595-BK    | M210-LAB, M211        | R4400                 | 1               | —              |
| ⊙       | B-430    | F A H              | 19.05              | —                   | 6.40               | M21-750-430-WT-CL | M210-LAB, M211        | R6200                 | 1               | —              |
| ⊙       | B-595    | F                  | 19.05              | —                   | 6.40               | M21-750-595-BL    | M210-LAB, M211        | R4400                 | 1               | —              |
| ⊙       | B-595    | F                  | 19.05              | —                   | 6.40               | M21-750-595-WT    | M210-LAB, M211        | R6000HF               | 1               | —              |

>>

# General Lab ID

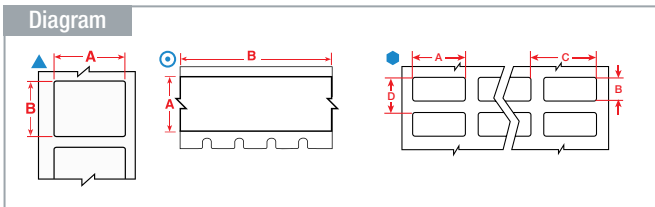

Labels are shown in order of label width.

The background colours in the Order Reference column represent the material colour.

See page 58 for Brady's range of label printers.

| Diagram | Material | Special Properties | Label Width A (mm) | Label Height B (mm) | Label Length B (m) | Order Reference    | Printer Compatibility | Printer Ribbon Series | Labels per Roll | Labels per Row |
|---------|----------|--------------------|--------------------|---------------------|--------------------|--------------------|-----------------------|-----------------------|-----------------|----------------|
| ⊙       | B-595    | F                  | 19.05              | –                   | 6.40               | M21-750-595-RD     | M210-LAB, M211        | R4400                 | 1               | –              |
| ⊙       | B-595    | F                  | 19.05              | –                   | 6.40               | M21-750-595-OR     | M210-LAB, M211        | R6000HF               | 1               | –              |
| ⊙       | B-595    | F                  | 19.05              | –                   | 6.40               | M21-750-595-GN     | M210-LAB, M211        | R4400                 | 1               | –              |
| ⊙       | B-595    | F                  | 19.05              | –                   | 6.40               | M21-750-595-YL     | M210-LAB, M211        | R6000HF               | 1               | –              |
| ⊙       | B-595    | F                  | 19.05              | –                   | 7.62               | MC-750-595-OR-BK   | BMP41, BMP51          | R6000HF               | 1               | –              |
| ⊙       | B-595    | F                  | 19.05              | –                   | 7.62               | MC-750-595-WT-BK   | BMP41, BMP51          | R6000HF               | 1               | –              |
| ⊙       | B-595    | F                  | 19.05              | –                   | 7.62               | MC-750-595-YL-BK   | BMP41, BMP51          | R6000HF               | 1               | –              |
| ⊙       | B-595    | F                  | 19.05              | –                   | 7.62               | MC-750-595-WT-RD   | BMP41, BMP51          | R4400                 | 1               | –              |
| ⊙       | B-595    | F                  | 19.05              | –                   | 7.62               | MC-750-595-BK-WT   | BMP41, BMP51          | R4400                 | 1               | –              |
| ⊙       | B-595    | F                  | 19.05              | –                   | 7.62               | MC-750-595-BL-WT   | BMP41, BMP51          | R4400                 | 1               | –              |
| ⊙       | B-595    | F                  | 19.05              | –                   | 7.62               | MC-750-595-GN-WT   | BMP41, BMP51          | R4400                 | 1               | –              |
| ⊙       | B-595    | F                  | 19.05              | –                   | 7.62               | MC-750-595-RD-WT   | BMP41, BMP51          | R4400                 | 1               | –              |
| ⊙       | B-403    |                    | R 19.05            | –                   | 7.62               | MC-750-403         | BMP41, BMP51          | R4300                 | 1               | –              |
| ⊙       | B-403    |                    | R 19.05            | –                   | 15.24              | M6C-750-403        | M610, M611            | R4300                 | 1               | 1              |
| ▲       | B-481    | F H                | 22.86              | 9.53                | –                  | M6-195-481         | M610, M611            | R6400                 | 500             | 1              |
| ▲       | B-481    | F H                | 22.86              | 19.05               | –                  | M6-194-481         | M610, M611            | R6400                 | 250             | 1              |
| ▲       | B-481    | F H                | 22.86              | 22.86               | –                  | M6-97-481          | M610, M611            | R6400                 | 250             | 1              |
| ▲       | B-498    | F R                | 25.40              | 12.70               | –                  | THT-59-498-2.5-SC  | BBP12                 | R7950                 | 2500            | 1              |
| ●       | B-423    | F A H              | 25.40              | 12.70               | –                  | B33-5-423          | i3300                 | B30 Monocolour        | 5000            | 3              |
| ▲       | B-432    | F A                | 25.40              | 12.70               | –                  | M-17-432-CL-BK     | BMP51                 | R6000HF               | 280             | –              |
| ▲       | B-499    | F N A              | 25.40              | 12.70               | –                  | M21-131-499        | M210-LAB, M211        | R4300                 | 1               | 1              |
| ▲       | B-423    | F A H              | 25.40              | 12.70               | –                  | M21-17-423         | M210-LAB, M211        | R6000HF               | 1               | 1              |
| ●       | B-499    | F N A              | 25.40              | 12.70               | –                  | B33-5-499          | i3300, i5300          | B30 Monocolour        | 5000            | 3              |
| ▲       | B-498    | F R                | 25.40              | 12.70               | –                  | M7-17-498          | M710                  | R6200                 | 500             | 1              |
| ▲       | B-430    | F A H              | 25.40              | 12.70               | –                  | M7-17-430          | M710                  | R6000HF               | 500             | 1              |
| ▲       | B-7425   | F N A H            | 25.40              | 12.70               | –                  | M6-17-7425         | M610, M611            | R4300, R6200, R6400   | 500             | 1              |
| ●       | B-488    | F A                | 25.40              | 12.70               | –                  | THT-5-488-10       | BBP12, i7100, i5100   | R4300, R7950          | 10000           | 3              |
| ▲       | B-499    | F N A              | 25.40              | 19.05               | –                  | M21-18-499         | M210-LAB, M211        | R4300                 | 1               | 1              |
| ▲       | B-423    | F A H              | 25.40              | 19.05               | –                  | M21-18-423         | M210-LAB, M211        | R6000HF               | 1               | 1              |
| ●       | B-499    | F N A              | 25.40              | 19.05               | –                  | B33-88-499         | i3300, i5300          | B30 Monocolour        | 2500            | 2              |
| ▲       | B-7425   | F N A H            | 25.40              | 19.05               | –                  | M6-18-7425         | M610, M611            | R4300, R6200, R6400   | 250             | 1              |
| ▲       | B-499    | F N A              | 25.40              | 25.40               | –                  | M7-19-499          | M710                  | R4300                 | 250             | 1              |
| ▲       | B-492    | F N H L            | 25.40              | 25.40               | –                  | M7-19-492          | M710                  | R6400                 | 250             | 1              |
| ▲       | B-498    | F R                | 25.40              | 31.75               | –                  | M-103-498          | BMP51                 | R6200                 | 160             | –              |
| ●       | B-499    | F N A              | 25.40              | 36.50               | –                  | B33-89-499         | i3300, i5300          | B30 Monocolour        | 2300            | 3              |
| ▲       | B-432    | F A                | 25.40              | 48.26               | –                  | M-78-432-CL-BK     | BMP51                 | R6000HF               | 100             | –              |
| ▲       | B-424    | F                  | 25.40              | 50.80               | –                  | M7-20-424          | M710                  | R4300                 | 100             | 1              |
| ●       | B-498    | F R                | 25.40              | 63.50               | –                  | B33-325-498        | i3300, i5300          | B30 Monocolour        | 700             | 2              |
| ●       | B-499    | F N A              | 25.40              | 63.50               | –                  | B33-325-499        | i3300, i5300          | B30 Monocolour        | 700             | 2              |
| ●       | B-498    | F R                | 25.40              | 101.60              | –                  | B33-326-498        | i3300, i5300          | B30 Monocolour        | 450             | 2              |
| ●       | B-499    | F N A              | 25.40              | 101.60              | –                  | B33-326-499        | i3300, i5300          | B30 Monocolour        | 450             | 2              |
| ●       | B-499    | F N A              | 25.40              | –                   | 4.88               | MC-1000-499        | BMP51                 | R4300                 | 1               | –              |
| ⊙       | B-595    | F                  | 25.40              | –                   | 6.10               | MC1-1000-595-CL-BK | BMP41, BMP51          | R6000HF               | 1               | –              |
| ⊙       | B-595    | F                  | 25.40              | –                   | 6.10               | MC1-1000-595-CL-WT | BMP41, BMP51          | R4400                 | 1               | –              |
| ⊙       | B-595    | F                  | 25.40              | –                   | 7.62               | MC1-1000-595-WT-BK | BMP41, BMP51          | R6000HF               | 1               | –              |
| ⊙       | B-595    | F                  | 25.40              | –                   | 7.62               | MC1-1000-595-YL-BK | BMP41, BMP51          | R6000HF               | 1               | –              |
| ⊙       | B-595    | F                  | 25.40              | –                   | 7.62               | MC1-1000-595-OR-BK | BMP41, BMP51          | R6000HF               | 1               | –              |
| ⊙       | B-595    | F                  | 25.40              | –                   | 7.62               | MC1-1000-595-BL-WT | BMP41, BMP51          | R4400                 | 1               | –              |
| ⊙       | B-595    | F                  | 25.40              | –                   | 7.62               | MC1-1000-595-RD-WT | BMP41, BMP51          | R4400                 | 1               | –              |
| ⊙       | B-595    | F                  | 25.40              | –                   | 7.62               | MC1-1000-595-GN-WT | BMP41, BMP51          | R4400                 | 1               | –              |
| ⊙       | B-595    | F                  | 25.40              | –                   | 7.62               | MC1-1000-595-WT-RD | BMP41, BMP51          | R4400                 | 1               | –              |
| ⊙       | B-595    | F                  | 25.40              | –                   | 7.62               | MC1-1000-595-BK-WT | BMP41, BMP51          | R4400                 | 1               | –              |

>>

F Freezer environment N Liquid nitrogen environment A Autoclave environment H Hot water bath (100°C) S Self-laminating label L Low-profile (extremely thin) label R Removable

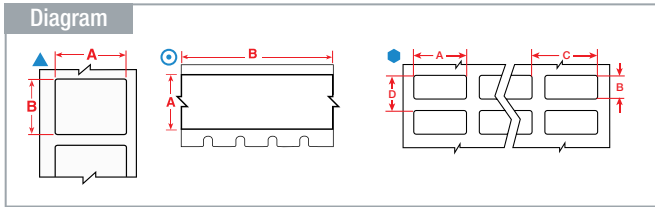

Labels are shown in order of label width.

The background colours in the Order Reference column represent the material colour.

See page 58 for Brady's range of label printers.

| Diagram | Material | Special Properties | Label Width A (mm) | Label Height B (mm) | Label Length B (m) | Order Reference   | Printer Compatibility | Printer Ribon Series  | Labels per Roll | Labels per Row |
|---------|----------|--------------------|--------------------|---------------------|--------------------|-------------------|-----------------------|-----------------------|-----------------|----------------|
| ⊙       | B-499    | <b>F N A</b>       | 25.40              | –                   | 9.14               | M7C-1000-499      | M710                  | R4300, R6000HF, R6200 | 1               | 1              |
| ⊙       | B-595    | <b>F</b>           | 25.40              | –                   | 15.24              | M7C-1000-595-YL   | M710                  | R6000HF, R4400-WT     | 1               | 1              |
| ⊙       | B-595    | <b>F</b>           | 25.40              | –                   | 15.24              | M7C-1000-595-WT   | M710                  | R6000HF               | 1               | 1              |
| ⊙       | B-595    | <b>F</b>           | 25.40              | –                   | 15.24              | M7C-1000-595-RD   | M710                  | R6000HF, R4400-WT     | 1               | 1              |
| ⊙       | B-595    | <b>F</b>           | 25.40              | –                   | 15.24              | M7C-1000-595-OR   | M710                  | R6000HF, R4400-WT     | 1               | 1              |
| ⊙       | B-595    | <b>F</b>           | 25.40              | –                   | 15.24              | M7C-1000-595-GN   | M710                  | R6000HF, R4400-WT     | 1               | 1              |
| ⊙       | B-595    | <b>F</b>           | 25.40              | –                   | 15.24              | M7C-1000-595-CL   | M710                  | R6000HF, R4400-WT     | 1               | 1              |
| ⊙       | B-595    | <b>F</b>           | 25.40              | –                   | 15.24              | M7C-1000-595-BL   | M710                  | R6000HF, R4400-WT     | 1               | 1              |
| ⊙       | B-595    | <b>F</b>           | 25.40              | –                   | 15.24              | M7C-1000-595-BK   | M710                  | R4400-WT              | 1               | 1              |
| ⊙       | B-430    | <b>F A H</b>       | 25.40              | –                   | 15.24              | M7C-1000-430      | M710                  | R6000HF               | 1               | 1              |
| ▲       | B-498    | <b>F</b>           | 26.67              | 6.35                | –                  | THT-199-498-3     | BBP12, i7100, i5100   | R4300, R7950          | 3000            | 1              |
| ▲       | B-498    | <b>F</b>           | 26.67              | 6.35                | –                  | THT-199-498-3-SC  | BBP12                 | R7950                 | 3000            | 1              |
| ▲       | B-7425   | <b>F N A H</b>     | 33.02              | 15.24               | –                  | M6-199-7425       | M610, M611            | R4300, R6200, R6400   | 250             | 1              |
| ●       | B-449    | <b>F A</b>         | 38.10              | 19.05               | –                  | THT-6-449-3       | BBP12, i7100, i5100   | R4300, R7950          | 3000            | 2              |
| ●       | B-449    | <b>F A</b>         | 38.10              | 19.05               | –                  | THT-6-449-1.5-SC  | BBP12                 | R7950                 | 1500            | 2              |
| ▲       | B-499    | <b>F N A</b>       | 38.10              | 19.05               | –                  | M21-136-499       | M210-LAB, M211        | R4300                 | 1               | 1              |
| ▲       | B-423    | <b>F A H</b>       | 38.10              | 19.05               | –                  | M21-30-423        | M210-LAB, M211        | R6000HF               | 1               | 1              |
| ●       | B-423    | <b>F A H</b>       | 38.10              | 19.05               | –                  | THT-6-423-10      | BBP12, i7100, i5100   | R6000HF               | 10000           | 2              |
| ▲       | B-499    | <b>F N A</b>       | 38.10              | 31.75               | –                  | M-132-499         | BMP51                 | R4300                 | 160             | –              |
| ●       | B-498    | <b>F</b>           | 38.10              | 101.60              | –                  | B33-327-498       | i3300, i5300          | B30 Monocolour        | 450             | 2              |
| ●       | B-499    | <b>F N A</b>       | 38.10              | 101.60              | –                  | B33-327-499       | i3300, i5300          | B30 Monocolour        | 450             | 2              |
| ●       | B-498    | <b>F</b>           | 38.10              | 152.40              | –                  | B33-328-498       | i3300, i5300          | B30 Monocolour        | 300             | 2              |
| ●       | B-499    | <b>F N A</b>       | 38.10              | 152.40              | –                  | B33-328-499       | i3300, i5300          | B30 Monocolour        | 300             | 2              |
| ⊙       | B-595    |                    | 38.10              | –                   | 6.10               | MC-1500-595-CL-BK | BMP51                 | R6000HF               | 1               | –              |
| ⊙       | B-595    |                    | 38.10              | –                   | 6.10               | MC-1500-595-CL-WT | BMP51                 | R4400                 | 1               | –              |
| ⊙       | B-595    |                    | 38.10              | –                   | 7.62               | MC-1500-595-OR-BK | BMP51                 | R6000HF               | 1               | –              |
| ⊙       | B-595    |                    | 38.10              | –                   | 7.62               | MC-1500-595-WT-BK | BMP51                 | R6000HF               | 1               | –              |
| ⊙       | B-595    |                    | 38.10              | –                   | 7.62               | MC-1500-595-YL-BK | BMP51                 | R6000HF               | 1               | –              |
| ⊙       | B-595    |                    | 38.10              | –                   | 7.62               | MC-1500-595-WT-RD | BMP51                 | R4400                 | 1               | –              |
| ⊙       | B-595    |                    | 38.10              | –                   | 7.62               | MC-1500-595-BK-WT | BMP51                 | R4400                 | 1               | –              |
| ⊙       | B-595    |                    | 38.10              | –                   | 7.62               | MC-1500-595-BL-WT | BMP51                 | R4400                 | 1               | –              |
| ⊙       | B-595    |                    | 38.10              | –                   | 7.62               | MC-1500-595-GN-WT | BMP51                 | R4400                 | 1               | –              |
| ⊙       | B-595    |                    | 38.10              | –                   | 7.62               | MC-1500-595-RD-WT | BMP51                 | R4400                 | 1               | –              |
| ⊙       | B-403    |                    | 38.10              | –                   | 7.62               | MC-1500-403       | BMP51                 | R4300                 | 1               | –              |
| ⊙       | B-403    |                    | 38.10              | –                   | 15.24              | M6C-1500-403      | M610, M611            | R4300                 | 1               | 1              |
| ▲       | B-498    | <b>F</b>           | 48.26              | 25.40               | –                  | M-128-498         | BMP41, BMP51          | R6200                 | 100             | –              |
| ⊙       | B-499    | <b>F N A</b>       | 48.26              | –                   | 9.14               | M7C-1900-499      | M710                  | R4300, R6000HF, R6200 | 1               | 1              |
| ▲       | B-423    | <b>F A H</b>       | 50.80              | 12.70               | –                  | THT-53-423-3      | BBP12, i7100, i5100   | R6000HF               | 3000            | 1              |
| ▲       | B-424    | <b>F</b>           | 50.80              | 12.70               | –                  | B33-53-424        | i3300                 | B30 Monocolour        | 2500            | 1              |
| ▲       | B-424    | <b>F</b>           | 50.80              | 12.70               | –                  | THT-53-424-3      | BBP12, i7100, i5100   | R4300, R7950          | 3000            | 1              |
| ▲       | B-499    | <b>F N A</b>       | 50.80              | 19.05               | –                  | M21-137-499       | M210-LAB, M211        | R4300                 | 1               | 1              |
| ▲       | B-423    | <b>F A H</b>       | 50.80              | 19.05               | –                  | M21-137-423       | M210-LAB, M211        | R6000HF               | 1               | 1              |
| ▲       | B-449    | <b>F A</b>         | 50.80              | 25.40               | –                  | THT-17-449-1.5-SC | BBP12                 | R7950                 | 1500            | 1              |
| ▲       | B-498    | <b>F</b>           | 50.80              | 25.40               | –                  | THT-17-498-3      | BBP12, i7100, i5100   | R4300, R7950          | 3000            | 1              |
| ▲       | B-498    | <b>F</b>           | 50.80              | 25.40               | –                  | THT-17-498-1.5-SC | BBP12                 | R7950                 | 1500            | 1              |
| ▲       | B-424    | <b>F</b>           | 50.80              | 25.40               | –                  | B33-17-424        | i3300                 | B30 Monocolour        | 1500            | 1              |
| ▲       | B-423    | <b>F A H</b>       | 50.80              | 25.40               | –                  | B33-17-423        | i3300                 | B30 Monocolour        | 1500            | 1              |
| ▲       | B-424    | <b>F</b>           | 50.80              | 25.40               | –                  | BM-20-424         | M610, M611, M710      | R4300                 | 1000            | 1              |
| ▲       | B-8423   | <b>F A</b>         | 50.80              | 25.40               | –                  | BPT-17-8423-1     | BBP12                 | R6000HF               | 1000            | 1              |
| ▲       | B-423    | <b>F A H</b>       | 50.80              | 25.40               | –                  | THT-17-423-3      | BBP12, i7100, i5100   | R6000HF               | 3000            | 1              |
| ▲       | B-424    | <b>F</b>           | 50.80              | 25.40               | –                  | THT-17-424-3      | BBP12, i7100, i5100   | R4300, R7950          | 3000            | 1              |
| ▲       | B-449    | <b>F A</b>         | 50.80              | 25.40               | –                  | THT-17-449-3      | BBP12, i7100, i5100   | R4300, R7950          | 3000            | 1              |

>>

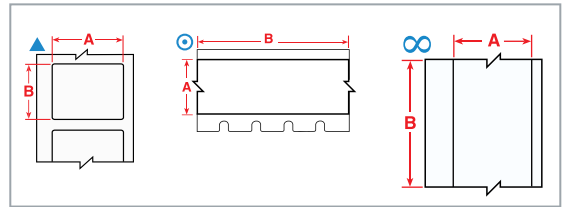

Labels are shown in order of label width.

The background colours in the Order Reference column represent the material colour.

See page 58 for Brady's range of label printers.

| Diagram | Material | Special Properties | Label Width A (mm) | Label Height B (mm) | Label Length B (m) | Order Reference | Printer Compatibility | Printer Ribbon Series | Labels per Roll | Labels per Row |
|---------|----------|--------------------|--------------------|---------------------|--------------------|-----------------|-----------------------|-----------------------|-----------------|----------------|
| ⊙       | B-430    | <b>F A H</b>       | 50.80              | –                   | 15.24              | M7C-1900-430    | M710                  | R6000HF               | 1               | 1              |
| ▲       | B-7425J  | <b>F N A H</b>     | 55.12              | 85.00               | –                  | J40-260-7425J   | J4000                 |                       | 340             | 1              |
| ∞       | B-7425J  | <b>F N A H</b>     | 57.15              | –                   | 30.48              | J40C-2250-7425J | J4000                 |                       | 1               | 1              |
| ▲       | B-423    | <b>F A H</b>       | 69.85              | 31.75               | –                  | M7-26-423       | M710                  | R6000HF               | 100             | 1              |
| ▲       | B-8423   | <b>F A</b>         | 69.85              | 31.75               | –                  | BPT-7-8423-1    | BBP12                 | R6000HF               | 1000            | 1              |
| ▲       | B-423    | <b>F A H</b>       | 76.20              | 25.40               | –                  | B33-18-423      | i3300                 | B30 Monocolour        | 1500            | 1              |
| ▲       | B-423    | <b>F A H</b>       | 76.20              | 25.40               | –                  | THT-18-423-3    | BBP12, i7100, i5100   | R6000HF               | 3000            | 1              |
| ▲       | B-430    | <b>F A H</b>       | 76.20              | 25.40               | –                  | THT-18-430-3    | BBP12, i7100, i5100   | R6000HF               | 3000            | 1              |
| ▲       | B-430    | <b>F A H</b>       | 76.20              | 50.80               | –                  | THT-19-430-1    | BBP12, i7100, i5100   | R6000HF               | 1000            | 1              |
| ∞       | B-7425J  | <b>F N A H</b>     | 101.60             | –                   | 30.48              | J40C-4000-7425J | J4000                 |                       | 1               | 1              |
| ▲       | B-7425J  | <b>F N A H</b>     | 104.90             | 154.94              | –                  | J40-262-7425J   | J4000                 |                       | 200             | 1              |
| ∞       | B-7425J  | <b>F N A H</b>     | 152.40             | –                   | 30.48              | J40C-6000-7425J | J4000                 |                       | 1               | 1              |
| ▲       | B-7425J  | <b>F N A H</b>     | 177.80             | 254.00              | –                  | J40-265-7425J   | J4000                 |                       | 100             | 1              |
| ▲       | B-7425J  | <b>F N A H</b>     | 203.20             | 133.35              | –                  | J40-321-2475J   | J4000                 |                       | 100             | 1              |
| ▲       | B-7425J  | <b>F N A H</b>     | 203.20             | 279.40              | –                  | J40-268-2475J   | J4000                 |                       | 100             | 1              |
| ∞       | B-7425J  | <b>F N A H</b>     | 203.20             | –                   | 30.48              | J40C-8000-7425J | J4000                 |                       | 1               | 1              |

**F** Freezer environment   **N** Liquid nitrogen environment   **A** Autoclave environment   **H** Hot water bath (100°C)   **S** Self-laminating label   **L** Low-profile (extremely thin) label   **R** Removable







## Label Printers and Barcode Scanners

Brady printers enable professionals to print highly specialised identification labels on-site and on demand. Partnered with labelling software for laboratories, Brady printers support considerable time savings and flexibility in sample identification. For enhanced security Brady offers a label attachment system that rivets an adhesive label to tissue cassettes before the tissue embedding process. To complete your sample ID automation, Brady has a range of barcode scanners which combine the industry's best imaging technology with a graphic display and rugged keyboard for fast, user-friendly data and inventory management.

- 58 Choose Your Printer
- 60 M210-LAB Label Printer
- 61 M211 Label Printer
- 62 BMP51 Label Printer
- 63 M610 Label Printer
- 64 M611 Label Printer
- 65 M710 Label Printer
- 66 BBP12 Label Printer
- 67 BradyPrinter i3300 Industrial Label Printer
- 68 BradyPrinter i5100 Industrial Label Printer
- 69 BradyPrinter i5300 Industrial Label Printer
- 70 BradyPrinter i7100 Industrial label printer
- 72 BradyJet J2000 Colour Label Printer
- 73 BradyJet J4000 Colour Label Printer
- 74 Label Creation Software
- 75 Scanners for Laboratories



# Choose Your Printer - portable printers



|  | M210-LAB Label Printer                               | M211 Label Printer   | BMP51 Label Printer                                  | M610 Label Printer  | M710 Label Printer  | M611 Label Printer  |
|--|--|--|--|---|---|---|
| <b>Recommended Usage per Day</b>               | 100  | 100  | 500  | 750   | 1000  | 750   |
| <b>Resolution (dpi)</b>                        | 203 dpi  | 203 dpi  | 300 dpi  | 300 dpi   | 300 dpi   | 300 dpi   |
| <b>Print Technology</b>                        | Thermal Transfer                                     | Thermal Transfer   | Thermal Transfer                                     | Thermal Transfer  | Thermal Transfer  | Thermal Transfer  |
| <b>Print Speed (mm/sec)</b>                    | 10.00 mm/s   | 15.24 mm/s   | 25.40 mm/s   | 50.80 mm/s  | 76.20 mm/s  | 33.80 mm/s  |
| <b>Max. Label Width (mm)</b>                   | 19.05 mm   | 19.05 mm   | 38.10 mm   | 50.80 mm  | 50.80 mm  | 50.80 mm  |
| <b>Text Sizes (pt)</b>                         | 6 - 40 pt  | 4 - 150 pt   | 4 - 103 pt   | 4 - 170 pt  | 4 - 174 pt  | Determined by software  |
| <b>Max Print Width</b>                         | 16.00 mm   | 15.75 mm   | 38.00 mm   | 50.80 mm  | 48.79 mm  | 50.80 mm  |
| <b>Bar Code Capability</b>                     | Code 128, Code 39, Data Matrix, QR code              | Code 128, Code 128A, Code 128B, Code 128C, Code 39, Code 39 Full ASCII, Code 93, Code 93 Full ASCII, EAN-13, EAN-13 Extension 2, EAN-13 Extension 5, EAN-8, EAN-8 Extension 2, EAN-8 Extension 5, GS1-128, HIBC, Interleaved 2 of 5, JAN-13, JAN-8, UPC-A, UPC-E, Data Matrix, PDF417, QR code | Code 128, Code 39, More through Brady Workstation    | Code 128, Code 39, Interleaved 2 of 5, UPC-A, UPC-E, EAN-13, QR code, Data Matrix | Code 128, Code 39, EAN-8, EAN-13, Interleaved 2 of 5, UPC-A, UPC-E, More through software, Data Matrix, QR code, More through Brady Workstation | Code 128A, Code 128B, Code 128C, Code 39, GS1 DataBar, HIBC, Interleaved 2 of 5, UPC-A, UPC-E, Data Matrix, More through Brady Workstation, PDF417, QR code |
| <b>Built-in Symbols</b>                        | 133  | Dependant on software  | 450  | 480   | 500+  | Dependant on software   |
| <b>Flash Memory</b>                            | 16 MB (2 MB available for storage, stores 12 labels) | Memory via connected mobile device   | 48 MB (stores up to 25,000 labels)                   | 512 MB RAM, 256 MB Flash  | 200 MB (stores up to 100,000 labels)  | 256 MB Flash, 512 MB RAM  |
| <b>Stand-alone Printing (Detached from PC)</b> | Stand-alone  | Peripheral   | Stand-alone & Peripheral                             | Stand-alone & Peripheral  | Stand-alone & Peripheral  | Peripheral  |
| <b>Colour Capability</b>                       | Monocolour   | Monocolour   | Monocolour   | Monocolour  | Monocolour  | Monocolour  |
| <b>Connectivity</b>                            | None   | Bluetooth® 5 Low Energy (class II)   | Bluetooth, Ethernet (optional), USB, WiFi (optional) | USB 2.0, Standalone Use   | Standalone Use, USB 2.0, USB-C  | Bluetooth, USB, USB 2.0, Wi-Fi  |
| <b>Keyboard</b>                                | ABC  | None   | QWERTY   | QWERTY, QWERTZ, AZERTY, CYRILLIC  | QWERTY, QWERTZ, AZERTY, CYRILLIC  | None  |
| <b>Power Supply</b>                            | Batteries, Rechargeable Battery, AC Adaptor          | AC Adaptor, Rechargeable Battery, USB  | Batteries, Rechargeable Battery, AC Adaptor          | AC Adaptor, Rechargeable Battery  | AC Adaptor, Rechargeable Battery  | AC Adaptor, Rechargeable Battery  |
| <b>Weight (kg)</b>                             | 0.75 kg  | 0.54 kg  | 1.18 kg  | 1.41 kg   | 2.45 kg   | 1.6 kg  |
| <b>Warranty</b>                                | 2 years  | 2 years  | 2 years  | 2 years   | 2 years   | 2 years   |

# Choose Your Printer - benchtop printers



|  | BBP12 Label Printer  | BradyPrinter i3300 Industrial Label Printer   | BradyPrinter i5100 Industrial Label Printer  | BradyPrinter i5300 Industrial Label Printer   | BradyPrinter i7100 Industrial Label Printer  | BradyJet J2000 Colour Label Printer               | BradyJet J4000 Colour Label Printer |
|--|--|---|--|---|--|---|-------------------------------------|
| <b>Recommended Usage per Day</b>               | 1000   | 3000  | 5000   | 5000  | 7000   | 3000  | 5000                                |
| <b>Resolution (dpi)</b>                        | 300 dpi  | 300 dpi   | 300 / 600  | 300 / 600   | 300 / 600  | Up to 4800  | Up to 4800                          |
| <b>Print Technology</b>                        | Thermal Transfer   | Thermal Transfer  | Thermal Transfer   | Thermal Transfer, Direct Thermal  | Direct Thermal, Thermal Transfer   | Inkjet  | Inkjet                              |
| <b>Print Speed (mm/sec)</b>                    | 101.60 mm/s  | 101.60 mm/s   | 300.00 mm/s  | 254.00 mm/s   | 300.00 mm/s  | 63.50 mm/s  | 114.30 mm/s                         |
| <b>Max. Label Width (mm)</b>                   | 116.84 mm  | 107.95 mm   | 105.66 mm  | 107.95 mm   | 109.98 mm  | 101.60 mm   | 203.20 mm                           |
| <b>Text Sizes (pt)</b>                         | –  | 4 - 250 pt  | –  | 4 - 250 pt  | –  | –   | –                                   |
| <b>Max Print Width</b>                         | 105.41 mm  | 101.98 mm   | 105.66 mm  | 101.98 mm   | 105.66 mm  | 101.60 mm   | 203.20 mm                           |
| <b>Bar Code Capability</b>                     | China Post, Codabar, Code 11, Code 128A, Code 128B, Code 128C, Code 128UCC, Code 39, Code 39 with check digit, Code 49, Code 93, Deutsche Post Identcode, Deutsche Post Leitcode, EAN-13, EAN-8, GS1 DataBar, GS1 DataBar Stacked Omnidirectional, GS1-128, Interleaved 2 of 5, Interleaved 2 of 5 with check digit, ITF-14, MSI, MSI with check digit, PLANET, Plessey, POSTNET, Telepen, UPC-A, UPC-E, Aztec, GS1 DataMatrix, MaxiCode, MicroPDF417, PDF417, QR code | Code 128A, Code 128B, Code 128C, Code 39, Code 93, EAN-13, EAN-8, HIBC, Interleaved 2 of 5, Interleaved 2 of 5 with check digit, JAN-13, JAN-8, UPC-A, Aztec, Data Matrix, MicroPDF417, PDF417, QR code | Codabar, Codablock F, Code 128A, Code 128B, Code 128C, Code 39, Code 39 Full ASCII, Code 93, Deutsche Post Identcode, Deutsche Post Leitcode, EAN/UCC 128, EAN/UPC, EAN/UPC Extension 2, EAN/UPC Extension 5, EAN-13, EAN-8, FIM, GS1 DataBar, GS1 DataBar Limited, GS1 DataBar Stacked, GS1 DataBar Stacked Omnidirectional, GS1 DataBar Truncated, GS1-128, HIBC, Interleaved 2 of 5, JAN-8, MSI, Plessey, POSTNET, UPC-A, UPC-E, UPC-E0, Aztec, Data Matrix, GS1 DataMatrix, MaxiCode, MicroPDF417, PDF417, QR code | Codabar, Code 128A, Code 128B, Code 128C, Code 39, Code 93, EAN-13, EAN-8, HIBC, Interleaved 2 of 5, JAN-8, JAN-8, MSI, Plessey, UPC-A, Aztec, Data Matrix, PDF417, QR code | Codabar, Codablock F, Code 128A, Code 128B, Code 128C, Code 39, Code 39 Full ASCII, Code 93, Deutsche Post Identcode, Deutsche Post Leitcode, EAN/UCC 128, EAN/UPC, EAN/UPC Extension 2, EAN/UPC Extension 5, EAN-13, EAN-8, FIM, GS1 DataBar, GS1 DataBar Limited, GS1 DataBar Stacked, GS1 DataBar Stacked Omnidirectional, GS1 DataBar Truncated, GS1-128, HIBC, Interleaved 2 of 5, JAN-8, MSI, Plessey, POSTNET, UPC-A, UPC-E, UPC-E0, Aztec, Data Matrix, GS1 DataMatrix, MaxiCode, MicroPDF417, PDF417, QR code | More through Brady Workstation                    | More through Brady Workstation      |
| <b>Built-in Symbols</b>                        | See Brady Workstation Software   | See Brady Workstation Software  | See Brady Workstation Software   | See Brady Workstation Software  | See Brady Workstation Software   | See Brady Workstation Software                    | Dependant on software               |
| <b>Flash Memory</b>                            | 128 MB Flash, 64 MB SDRAM, SD Flash memory card up to 32 GB  | 512 MB RAM, 195 MB IFFS Flash   | 256 MB RAM, 50 MB IFFS Flash   | 512 MB RAM, 195 MB IFFS Flash   | 256 MB RAM, 50 MB IFFS Flash, SD card up to 512 GB   | No internal memory                                | –                                   |
| <b>Stand-alone Printing (Detached from PC)</b> | Peripheral   | Peripheral  | Stand-alone & Peripheral   | Peripheral  | Stand-alone & Peripheral   | Peripheral  | Peripheral                          |
| <b>Colour Capability</b>                       | Monocolour   | Monocolour  | Monocolour   | Monocolour  | Monocolour   | Full Colour                                       | Full Colour                         |
| <b>Connectivity</b>                            | Ethernet, Serial, USB  | Ethernet, USB, USB 2.0  | Ethernet, WiFi (optional), Bluetooth (optional), Serial, USB   | Cabled, Ethernet, USB 2.0, USB Host   | Ethernet, I/O connection (optional), Bluetooth (optional), WiFi (optional), Serial, USB  | USB   | USB, Ethernet                       |
| <b>Keyboard</b>                                | Optional   | None  | None   | None  | None   | None  | None                                |
| <b>Hardware Options</b>                        | Cleaning swabs, Cutter (factory installed option), External media holder, Peel & Present, Universal keyboard   | Cleaning kit, Cleaning swabs, Cutter cleaning tool, Media wipers, Power cord, USB cable   | Auto cutter, Bluetooth adapter, Cleaning swabs, Label roll holder, Media roll holder, Platen rollers, Print roller, Ribbon take up spindle, WLAN USB stick   | Print head (300 dpi), Print head (600 dpi), Print roller  | 101.60 mm media adapter, Auto cutter, Cleaning swabs, Cutter perforator, Cutter with tray, Extended peel plate, I/O interface accessory, Narrow width print rollers, Peel off, Platen rollers, Present sensor, Rewinder, WLAN USB stick with antenna   | Alignment roll, Cleaning kit, Ink pads, USB cable | Ink cartridge                       |
| <b>Weight (kg)</b>                             | 2.3 kg   | 5.22 kg   | 6.17 kg  | 15.0 kg   | 10 kg  | 3.20 kg   | 16 kg                               |
| <b>Warranty</b>                                | 1 year   | 1 year  | 2 years  | 2 years   | 2 years  | 1 year  | 1 year                              |



## M210-LAB

### LABEL PRINTER

#### Tough on the outside, Genius on the inside

Combining a tough exterior with smart printing capabilities, the M210-LAB hand-held label printer can take a hit and still perform. **Laboratory symbols** & vial/tube auto-sizing, plus drop-lock-and-go cartridges, plus a rechargeable Lithium-ion battery adds up to a powerful and affordable tool for quick and efficient label making in any type of laboratory. **High quality label materials** designed specifically for the laboratory environment create durable, professional looking labels for your laboratory samples and beyond.

#### Designed for Laboratory

- Materials available for applications such as cryo vials and slides
- Greek symbols commonly used in laboratory, intuitive menu structure for symbols
- Vial label function automatically cuts the tape according to the size of the vial
- Automated serialisation
- Time & Date stamp

#### Easy to use

- 3 line LCD display provides clear visibility
- ABC keypad, graphics library, hot keys and menu functions for fast label creation
- Long life rechargeable Lithium-ion battery\*
- Smart Cell Technology for automatic label setup
- Automatic label formatting for commonly used label types in laboratory
- Magnet accessory\* for more convenient use and storage on smaller laboratory benches and a lanyard for hands-free operation
- Ergonomic, centre balanced printer with grab and go ridges grip for easy handling

#### Exceptional material variety and durability

- Laboratory specific materials designed to withstand harsh laboratory environments.
- High quality, long lasting labels that stick and stay stuck
- Prints durable true-sized 6 – 19 mm wide identification to maximise amount of data
- Adjust the length of the labels using the high performance continuous material
- Fulfill your requirements with a range of different industry specified materials that last

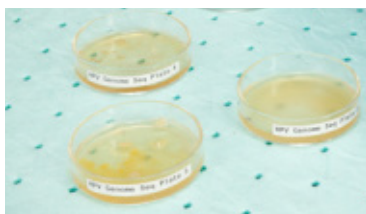

#### View online

Visit [www.bradyeurope.com/M210-LAB](http://www.bradyeurope.com/M210-LAB) for more information on the M210-LAB Label Printer



### M210-LAB Label Printer

| Article No. | Order Ref. | Description                          |
|-------------|------------|--------------------------------------|
| 152261      | M210-LAB   | M210-LAB Label Printer - Carton Pack |

This printer ships in a carton pack with a Quick Start Guide and an M21-750-7425 label cartridge

### M210-LAB Starter Kits

| Article No. | Order Ref.      | Description     |
|-------------|-----------------|-----------------|
| 311319      | M210-LAB-kit EU | M210 LAB Kit EU |
| 311320      | M210-LAB-kit UK | M210 LAB Kit UK |
| 311321      | M210-LAB-kit US | M210 LAB Kit US |

This kit ships in hard case with a M210-Lab printer, a Li-ion Battery, a Power Cord, a Quick Start Guide and a M21-750-7425 Label Cartridge.



### Accessories

| Article No. | Order Ref.   | Description   |
|-------------|--------------|---|
| 110416      | BMP21-AC EUR | AC Adaptor, Europe 220V   |
| 110417      | BMP21-AC UK  | AC Adaptor, UK 240V   |
| 110937      | BMP21-AC     | AC Adaptor, US 110V   |
| 170421      | M210-HC      | Hard Case for M210 and M210-LAB                                       |
| 170420      | M210-BATTERY | Lithium-ion Battery Pack for M210 Label Printer                       |
| 170385      | M21-BELTCLIP | M210 and M211 Belt Clip   |
| 170425      | M21-MAGNET   | Magnet Only Accessory   |
| 170424      | M210-TOOL    | Multifunctional Accessory   |
| 150617      | BMP-SC-1     | Protective softbag for portable printers for M211; M210; BMP21; BMP51 |

# M211

## LABEL PRINTER

Design, preview and print – all from your phone. Simple and intuitive, the M211 Label Printer is built for the job site, running all day on a full charge while resisting drops, shocks and crushes.

**Simple. Easy. Intuitive.** Seamlessly design, preview and print labels from the industry leading Express Labels App on your familiar smartphone and swiftly connect to your printer.

**Label it once.** Now with both pre-sized and continuous labels in 90+ cartridges, filled to the brim with reliable, tested and dedicated label materials that stay attached and remain legible on every surface and in any environment.

**Survives and thrives on any worksite.** Ready to label all day with a lightweight, 0.5 kg printer, a powerful battery, drop-lock-print label cartridges and a built-in auto-cutter. Survives falls from up to 1.8m, 110 kg crushes, and shocks.

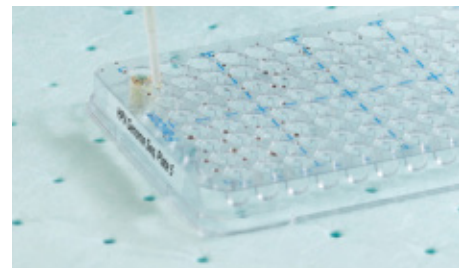
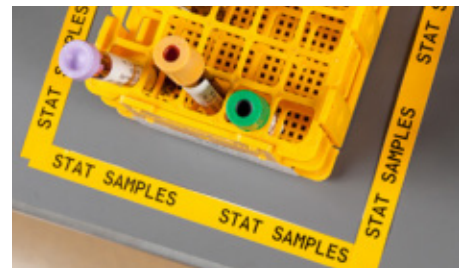

### M211 Label Printer

| Article No. | Description         |
|-------------|---------------------|
| 170381      | M211 Printer - EMEA |

This printer ships in a carton pack with M21-750-499 label cartridge, AC power cord with EU, UK and US plugs and Quick Start Guide.

### M211 Label Printer Kit

| Article No. | Description   |
|-------------|---------------|
| 170390      | M211 EMEA kit |

This kit ships in a hard case with a M211 Printer, M21-750-499 Label Cartridge, Quick Start Guide, AC Power cord with EU, UK and US plugs, Belt Clip and Power Pack.

### Accessories

| Article No. | Description                |
|-------------|----------------------------|
| 170385      | M211 Belt Clip             |
| 170386      | M211 Hard Case             |
| 170387      | M211 Power Brick           |
| 170388      | M211 AC Wall adapter EMEA  |
| 170425      | M211 Magnet Only Accessory |

▶ **Label creation, just a tap away.**

Go mobile and get more options with Express Labels.

[www.brady.eu/software/express-labels-mobile](http://www.brady.eu/software/express-labels-mobile)





# BMP51 LABEL PRINTER

The BMP51 Label Printer is a compact, versatile portable printer with built-in Bluetooth® technology for wireless printing.

- Identify your samples quickly and more efficiently
- Portable/Handheld
- Labels withstand extreme laboratory temperatures and solvents
- Durable built-in cutter that retains the label after it's cut until you need it
- Built-in Bluetooth® or optional Wi-Fi card for wireless printing from a network
- A magnet accessory to keep your printer handy
- Serialisation feature for quicker aliquots

### ▶ View online

Visit [www.bradyeurope.com/BMP51](http://www.bradyeurope.com/BMP51) for more information on the BMP51 Label Printer.

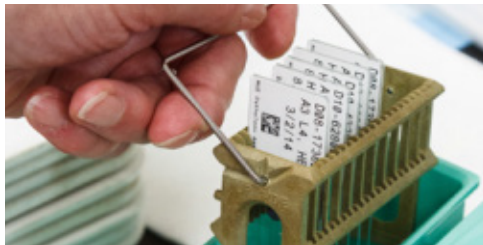

## BMP51 Label Printer

| Article No. | Order Ref.           | Description   |
|-------------|----------------------|---|
| 710894      | BMP51 PRINTER EU     | BMP51 Label Printer - EU                                  |
| 306856      | BMP51-EU-LABS        | BMP51 Label Printer - EU with Brady Workstation LAB Suite |
| 710898      | BMP51 PRINTER KIT UK | BMP51 Label Printer - UK                                  |
| 306857      | BMP51-UK-LABS        | BMP51 Label Printer - UK with Brady Workstation LAB Suite |

The Basic Suite is included with every printer, all you need to do is download it. [Workstation.BradylD.com/Free](http://Workstation.BradylD.com/Free)

▶ For more information about the Brady Workstation Software Suites, see page 74.

## BMP51 Laboratory kits

| Article No. | Order Ref.       | Description             |
|-------------|------------------|-------------------------|
| 198655      | BMP51-LAB KIT-EU | BMP51 Laboratory Kit EU |
| 198658      | BMP51-LAB KIT-UK | BMP51 Laboratory Kit UK |

This printer ships in a hard case with a Rechargeable Lithium Ion Battery, USB Cable, AC adaptor with power cord, Product CD, Brady Printer Drivers CD, Quick Start Guide, a Bluetooth network card, a Brady Workstation LAB Suite, M-122-461, M-131-499 and an MC1-1000-422 cartridge.

## BMP51 Accessories

| Article No. | Order Ref.                | Description  |
|-------------|---------------------------|--|
| 710612      | M41/50/61/71/611-AC-BC-EU | AC Adaptor, Europe 220V                                      |
| 710613      | M41/50/61/71/611-AC-BC-UK | AC Adaptor, UK 240V  |
| 114883      | M41/50/61/71/611-AC-BC-NA | AC Adaptor, USA 120V   |
| 143109      | M50-HC                    | BMP50 Series Hard Carry Case                                 |
| 143108      | M50-MAGNET                | BMP50 Series Magnet Accessory                                |
| 143115      | M50-BATT-TRAY             | BMP50 Series Spare Battery Tray for 8 AA batteries           |
| 142267      | NET-LAN                   | LAN Network Card   |
| 142260      | BMP-UBP 12V               | Rechargeable Lithium Ion battery for the BMP51 printer       |
| 710902      | UBP-Li-ION-AC-EUR         | Univeral Li-ion Battery Pack with AC Adaptor/Battery Pack EU |
| 710903      | UBP-Li-ION-AC-UK          | Univeral Li-ion Battery Pack with AC Adaptor/Battery Pack UK |
| 142261      | BMP-UBP-AC                | Univeral Li-ion Battery Pack with AC Adaptor/Battery Pack US |

# M610 LABEL PRINTER

## THE DURABILITY YOUR WORK DEMANDS

### Portable just got more powerful

Get the job done right! In the facility or in the field.

### Save and store labels on board with the widest range of data entry options.

#### Get more with these time-saving features:

- 50.8mm per second print speed
- Enhanced Gen3 li-ion battery
- Store and import data files from USB-thumb drive
- Import and save files, lists and graphics
- Design and print labels using the keypad, the mobile app or the desktop software
- Prints text, barcodes, shapes and images



## DO MORE WITH ENHANCED CAPABILITIES



1.8m DROP MILITARY STANDARD SHOCK RESISTANCE



PRINT 4,500 LABELS ON A FULL CHARGE



WIDER (-18° to 46°C) OPERATING TEMP. RANGE

### View online

Visit [www.bradyeurope.com/M610](http://www.bradyeurope.com/M610) for more information on the M610 label printer.



## M610 Label printer

| Article No. | Order Ref.        | Description                                   |
|-------------|-------------------|---|
| 317790      | M610-QWERTY-UK    | M610 Label Printer - QWERTY UK                |
| 317791      | M610-QWERTY-UK-BT | M610 Label Printer - QWERTY UK with bluetooth |
| 317792      | M610-AZERTY       | M610 Label Printer - AZERTY                   |
| 317793      | M610-AZERTY-BT    | M610 Label Printer - AZERTY with bluetooth    |
| 317794      | M610-US           | M610 Label Printer - QWERTY US                |
| 317795      | M610-QWERTZ-BT    | M610 Label Printer - QWERTZ with bluetooth    |
| 317796      | M610-US-BT        | M610 Label Printer - QWERTY US with bluetooth |
| 317797      | M610-QWERTY-EU    | M610 Label Printer - QWERTY EU                |
| 317798      | M610-QWERTY-EU-BT | M610 Label Printer - QWERTY EU with bluetooth |
| 317799      | M610-CYRILLIC-BT  | M610 Label Printer - CYRILLIC with bluetooth  |

## M610 Accessories

| Article No. | Order Reference | Description  |
|-------------|-----------------|--|
| 018556      | PCK-5           | Printer cleaning kit                                   |
| 150618      | BMP-SC-2        | Protective softbag for portable printers               |
| 175671      | M610-HC         | Hard Case for M610 Label Printer                       |
| 175672      | M610-MAGNET     | Magnet for M610 Label Printer                          |
| 175673      | M-LION-BATTERY  | Rechargeable Lithium-ion Battery for M610/M710 printer |
| 175674      | M-NIMH-BATTERY  | Rechargeable NiMH Battery for M610/M710 printers       |



The Basic Suite is included with every printer, all you need to do is download it.

**Workstation.BradyID.com/Free**

For more information about the Brady Workstation Software Suites, see page 74.



## M611 LABEL PRINTER

### Keep track of your sample data

Your sample is only as valuable as the data behind it. Maintain data integrity with high performance identification — stay connected to your data with the M611 Label Printer and Brady Workstation Mobile or Desktop Software. See page 74 for more information about these software options.

Through data automation, you can seamlessly get your data on your label in a format you need. It's all in the powerful Brady Workstation Express Labels Mobile App that connects your data to label templates so you keep your data integrity without any extra work. When it's time to start creating labels, simply pull from your data file and get to work.

#### ▶ View online

Consult the videos of the M611 Label Printer on: [www.bradyeurope.com/M611](http://www.bradyeurope.com/M611)



#### Get more with these time-saving features:

- 50.8mm per second print speed
- Share label files in multiple locations
- Store and import data files from USB-thumb drive
- 50.8mm print width
- Compact and lightweight
- Connect to computer using Wi-Fi or USB cable or use your smartphone and the Express Label App



## MODERNISE WORKFLOWS IN MULTIPLE WAYS



**CREATE LABELS IN OFFICE OR SHOP. SAVE FOR EASY SHARING**



**SHARE VIA EMAIL TO FIELD, PRINT RIGHT FROM THE PRINTER TOUCH SCREEN OR PHONE**



**CONNECT UP TO 5 DEVICES VIA BLUETOOTH. SAVE TIME & HASSLE LABELLING ON-SITE**

### Printers

| Article No. | Order Ref.   | Description             |
|-------------|--------------|-------------------------|
| 317844      | M611-EU-BT-W | M611 Label Printer - EU |
| 317836      | M611-UK-BT-W | M611 Label Printer - UK |
| 317843      | M611-AM-BT-W | M611 Label Printer - US |

\* This printer ships in a cardboard box holding a USB cable, a quick start guide, an AC powercord, a USB stick holding product info and Windows driver, a Brady Workstation Basic Design Suite, a roll of M6-11-427 and an M61-R4310 ribbon.

### Kits

| Article No. | Order Ref.   | Description  |
|-------------|--------------|--|
| 317840      | M611-EU-LABS | M611 Label Printer - EU with Brady Workstation LAB Suite |
| 317841      | M611-UK-LABS | M611 Label Printer - UK with Brady Workstation LAB Suite |
| 317842      | M611-US-LABS | M611 Label Printer - US with Brady Workstation LAB Suite |

### Accessories

| Article No. | Order Ref.  | Description                      |
|-------------|-------------|----------------------------------|
| 175603      | M611-HC     | Hard Case for M611 Label Printer |
| 175604      | M611-MAGNET | Magnet for M611 Label Printer    |
| 175605      | M611-SLING  | Sling Pack for M611 Printer      |



# M710 LABEL PRINTER

The M710 label printer can print on more than 60 material options including several which are specifically suitable for a laboratory environment - all designed with Brady's industrial strength durability.

## Get more with these time-saving features:

- 76mm per second print speed
- Prints 4,500 labels on one charge
- Withstands 1.2m drops, blowing sand and dust
- Use keypad, your smartphone and the Express Label App or the software to print labels
- Prints text, barcodes, shapes and images
- Label saving, sharing and data imports



### ▶ View online

Visit [www.bradyeurope.com/M710](http://www.bradyeurope.com/M710) for more information on the M710 Label Printer.



## GET MORE DONE WITH:



**LIGHTNING-FAST PRINT SPEEDS**



**SHOP-TO-FIELD FLEXIBILITY**



**MORE THAN 60 MATERIAL OPTIONS**



## M710 Label Printer

| Article No. | Order Ref.        | Description                                   |
|-------------|-------------------|---|
| 317814      | M710-AZERTY-EU    | M710 Label Printer AZERTY                     |
| 317815      | M710-WB-AZERTY-EU | M710 Label Printer AZERTY, Wifi, BT           |
| 317817      | M710-WB-CYRILLIC  | M710 Label Printer Cyrillic with Wifi and BT  |
| 317810      | M710-QWERTY-EU    | M710 Label Printer QWERTY EU                  |
| 317811      | M710-WB-QWERTY-EU | M710 Label Printer QWERTY EU with Wifi and BT |
| 317812      | M710-QWERTY-UK    | M710 Label Printer QWERTY UK                  |
| 317813      | M710-WB-QWERTY-UK | M710 Label Printer QWERTY UK with Wifi and BT |
| 317816      | M710-WB-QWERTZ    | M710 Label Printer QWERTZ with Wifi and BT    |

This printer ships in a hard case holding a USB cable, a quick start guide, a product USB (with product info and Windows driver), a Li-Ion Rechargeable Battery, an AC Adapter, a Brady Workstation Software, a Media Adapter, a roll of M7C-1000-595-WT and an M7-R6000 ribbon.

▶ The Basic Suite is included with every printer, all you need to do is download it. **Workstation.BradyID.com/Free**

For more information about the Brady Workstation Software Suites, see page 74.

## M710 Accessories

| Article No. | Order Reference | Description  |
|-------------|-----------------|--|
| 175664      | M710-HC         | Hard Case M710 Label Printer                           |
| 175665      | USB-C-A-CABLE   | USB-C to USB Type A Cord                               |
| 175673      | M-LIION-BATTERY | Rechargeable Lithium-ion Battery for M610/M710 printer |
| 175674      | M-NIMH-BATTERY  | Rechargeable NiMH Battery for M610/M710 printers       |
| 114886      | M71-CLEAN       | Cleaning Kit   |
| 147998      | M71-ADAPT-BK    | Media Adaptor for high-end portable printer            |
| 150619      | BMP-SC-3        | Protective softbag for portable printers               |



## BBP12 LABEL PRINTER

The BBP12 Label Printer is an entry level benchtop label printer for cable, component, product and laboratory sample identification that offers great value for money. The compact BBP12 offers a high print speed of 100 mm/second and can handle a wide range of highly durable and specialised Brady identification labels.

### Simple, Efficient Design

- Compact in size, fits on every desk
- Default Ethernet Connectivity, allowing you to work in a network
- Connect any universal keyboard via USB 2.0 to work in stand-alone mode
- Full colour LCD Display and intuitive software interface are simple to use, so no extensive training is required
- Simple calibration menu with easy 1-2-3 step printing
- Best price/quality in the market for low volume printing
- Comes with a free unwinder accessory to print larger label rolls

### View online

Visit [www.bradyeurope.com/BBP12](http://www.bradyeurope.com/BBP12) for more information on the BBP12 Label Printer.



### Performance

- Prints a wide range of identification labels from 6 mm up to 112 mm wide
- Standard 300 dpi print quality allowing accurate image & barcode positioning on small labels
- With its powerful 32 bit processor and its extended memory it can print up to 100 mm / sec
- The printer supports the industry-standard Zebra® and Eltron® programming languages
- Print time and date on to your labels via the “Real time clock feature”



While the BBP12 label printer primarily uses 25.40 mm core materials for low to medium volume printing, an unwinder is available should high volume printing be needed.

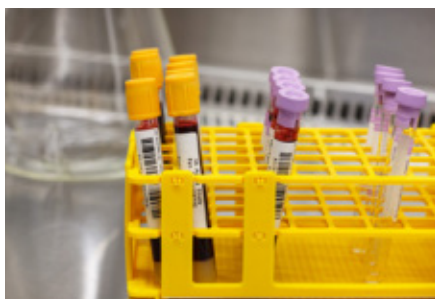
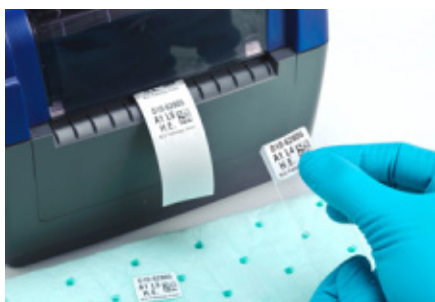

### BBP12 Label Printer

| Article No. | Order Ref.        | Description  |
|-------------|-------------------|--|
| 306867      | BBP12-EU-U-C-LABS | BBP12 Label printer 300 dpi - EU with Cutter, Unwinder and Brady Workstation LAB Suite |
| 195966      | BBP12-EU+U+Cutter | BBP12 Label printer 300 dpi - EU with Cutter and Unwinder                              |
| 195566      | BBP12-EU+Unwinder | BBP12 Label printer 300 dpi - EU with Unwinder   |
| 306866      | BBP12-EU-U-LABS   | BBP12 Label printer 300 dpi - EU with Unwinder and Brady Workstation LAB Suite         |
| 306869      | BBP12-UK-U-C-LABS | BBP12 Label printer 300 dpi - UK with Cutter, Unwinder and Brady Workstation LAB Suite |
| 195967      | BBP12-UK+U+Cutter | BBP12 Label printer 300 dpi - UK with Cutter and Unwinder                              |
| 195567      | BBP12-UK+Unwinder | BBP12 Label printer 300 dpi - UK with Unwinder   |
| 306868      | BBP12-UK-U-LABS   | BBP12 Label printer 300 dpi - UK with Unwinder and Brady Workstation LAB Suite         |
| 306871      | BBP12-US-U-C-LABS | BBP12 Label printer 300 dpi - US with Cutter, Unwinder and Brady Workstation LAB Suite |
| 195968      | BBP12-US+U+Cutter | BBP12 Label printer 300 dpi - US with Cutter and Unwinder                              |
| 195568      | BBP12-US+Unwinder | BBP12 Label printer 300 dpi - US with Unwinder   |
| 306870      | BBP12-US-U-LABS   | BBP12 Label printer 300 dpi - US with Unwinder and Brady Workstation LAB Suite         |

▶ The Basic Suite is included with every printer, all you need to do is download it. **Workstation.BradyID.com/Free**  
For more information about the Brady Workstation Software Suites, see page 74.

### BBP12 Printer kits

| Article No. | Order Ref.       | Description                                       |
|-------------|------------------|---|
| 198596      | BBP12-LAB Kit-EU | BBP12 Label printer 300 dpi - Laboratory Kit - EU |
| 198597      | BBP12-LAB Kit-UK | BBP12 Label printer 300 dpi - Laboratory Kit - UK |
| 198598      | BBP12-LAB Kit-US | BBP12 Label printer 300 dpi - Laboratory Kit - US |

This BBP12 label printer comes in a cardboard box. It ships with an unwinder, USB Cable, power cord, product CD, Quick Start Guide, Brady Workstation Laboratory ID Suite, THT-131-461-3, THT-156-492-3, THT-163-499-3, R7950 35mmx70m /O, R6400 65mmx70m / O, R4900 65mmx70m /O

### Accessory

| Article No. | Order Ref.     | Description      |
|-------------|----------------|------------------|
| 361064      | BBP12/BBP11-VP | Peel and Present |

## BradyPrinter i3300

### INDUSTRIAL LABEL PRINTER

The BradyPrinter i3300 Industrial Label Printer is a completely hassle free, easy to use PC-based printer. It can print a full range of safety and facility labels and signs as well as die cut labels for wire identification, product identification and laboratory identification.

#### Print a huge range of labels & signs

With the BradyPrinter i3300, you can print a huge range of reliable labels and signs at your location in monocolour. More than 50 different Brady label materials are compatible with the BradyPrinter i3300. Labels & signs that can be printed with the BradyPrinter i3300 include:

- wire & cable identification labels
- product and laboratory identification labels
- safety and facility signs

These can be used both in- and outdoor, and include specialty solutions like ToughWash labels and ToughStripe floor marking.

#### Designed to last

The BradyPrinter i3300 prints on Brady's industrial grade labels that have been designed to last in challenging conditions. All Brady labels have been tested in line with international ASTM test methods and a technical data sheet is available for every material.

#### Extremely easy to use

The BradyPrinter i3300 is extremely easy to use and features auto-calibration and automatic label material setup. This will enable you to immediately start printing the signs and labels you need. Switching to another label material is easy and extremely fast thanks to the printer's 'drop-in' label materials and matching ink ribbons that can be switched out in less than 20 seconds. When used with Brady Workstation apps, a wide variety of sign & label design options becomes available.



▶ **View online**

Learn more about the BradyPrinter i3300 on:

[www.bradyeurope.com/i3300](http://www.bradyeurope.com/i3300)



### Printer

| Article No. | Order Ref.        | Description   |
|-------------|-------------------|---|
| 149553      | i3300-300-C-EU    | i3300 Industrial Label Printer- EU  |
| 241130      | i3300-C-EU-LABS   | i3300 Industrial Label Printer- EU with Brady Workstation LAB Suite           |
| 149555      | i3300-300-C-UK    | i3300 Industrial Label Printer- UK  |
| 241132      | i3300-C-UK-LABS   | i3300 Industrial Label Printer- UK with Brady Workstation LAB Suite           |
| 149551      | i3300-300-C-US    | i3300 Industrial Label Printer- US  |
| 241128      | i3300-C-US-LABS   | i3300 Industrial Label Printer- US with Brady Workstation LAB Suite           |
| 149554      | i3300-300-C-EU-WF | i3300 Industrial Label Printer with Wifi- EU                                  |
| 241131      | i3300-C-EU-W-LABS | i3300 Industrial Label Printer with Wifi- EU with Brady Workstation LAB Suite |
| 149556      | i3300-300-C-UK-WF | i3300 Industrial Label Printer with Wifi- UK                                  |
| 241133      | i3300-C-UK-W-LABS | i3300 Industrial Label Printer with Wifi- UK with Brady Workstation LAB Suite |
| 149552      | i3300-300-C-US-WF | i3300 Industrial Label Printer with Wifi - US                                 |
| 241129      | i3300-C-US-W-LABS | i3300 Industrial Label Printer with Wifi- US with Brady Workstation LAB Suite |

This i3300 printer comes in a cardboard box. It ships with a power cord, a Brady Workstation LAB Suite, a USB cable, a product CD holding the manual, a cleaning kit and a printed quick start guide

▶ The Basic Suite is included with every printer, all you need to do is download it. **Workstation.BradyID.com/Free**

For more information about the Brady Workstation Software Suites, see page 74.

### Accessories

| Article No. | Order Ref.  | Description   |
|-------------|-------------|---|
| 036612      | Squeegee    | Squeegee  |
| 120994      | B30-TROLLEY | Trolley for BBP3x, S3xxx, i3300                                       |
| 133251      | PCK-6       | Printer Cleaning Kit, Thermal Transfer Printers                       |
| 142114      | B31-WIPER   | Media Wiper 5 Pack  |
| 142116      | B31-CCT     | Cutter Cleaning Tool for BBP30, BBP31, BBP33, S3100 and i3300 printer |

## BradyPrinter i5100

### INDUSTRIAL LABEL PRINTER

#### The perfect mix of performance and smarts

The BradyPrinter i5100 Industrial Label Printer is smart and easy to use, offers excellent performance and prints over 1200 standard identification labels plus user specific, tailored custom labels.

#### Smart & connected

- Communicates automatically with our label design apps, label consumables and ink ribbons for a smooth and fast printer setup.
- Intuitive, full colour touch screen includes a label and print status monitor which also informs you when the installed ink ribbon does not optimally match the inserted label supplies.
- Brady labels can easily be loaded thanks to a self-centering roll holder and automatic calibration and label setup.
- The printer features a range of standard ports for common industrial connectivity scenarios.

#### Excellent print performance

- With 300 and 600 dpi printing, the BradyPrinter i5100 offers crisp, high quality printing on reliable, industrial grade labels from 5 up to 110 mm.
- Driven by a powerful 32 bit and 800 Mhz internal printer processor, the i5100 prints at a speed of up to 300 mm/sec at 300 dpi.
- The printer's interchangeable platen rollers help to keep its performance at maximum, even after intensive use.

#### Reliable, industrial grade labels

- The BradyPrinter i5100 can print on 70 label materials, more than 1200 stock label parts and tailored custom label materials and parts.
- Laboratory labels: cryo tube labels, slide labels, removable glassware labels, well plate labels, tissue cassette labels a.o.

#### Printers

| Article No. | Order Ref.         | Description  |
|-------------|--------------------|--|
| 149458      | i5100-300-UKEU     | BradyPrinter i5100 300 dpi - UK/EU   |
| 306872      | i5100-300-EU-LABS  | BradyPrinter i5100 300 dpi - UK/EU with Brady Workstation LAB Suite            |
| 149459      | i5100-300-C-UKEU   | BradyPrinter i5100 300 dpi - UK/EU with Cutter                                 |
| 306874      | i5100-300C-EU-LABS | BradyPrinter i5100 300 dpi - UK/EU with Cutter and Brady Workstation LAB Suite |
| 198766      | i5100-300-US       | BradyPrinter i5100 300 dpi - US  |
| 306873      | i5100-300-US-LABS  | BradyPrinter i5100 300 dpi - US with Brady Workstation LAB Suite               |
| 198767      | i5100-300-C-US     | BradyPrinter i5100 300 dpi - US with Cutter                                    |
| 306875      | i5100-300C-US-LABS | BradyPrinter i5100 300 dpi - US with Cutter and Brady Workstation LAB Suite    |
| 149461      | i5100-600-UKEU     | BradyPrinter i5100 600 dpi - UK/EU   |
| 306876      | i5100-600-EU-LABS  | BradyPrinter i5100 600 dpi - UK/EU with Brady Workstation LAB Suite            |
| 149462      | i5100-600-C-UKEU   | BradyPrinter i5100 600 dpi - UK/EU with Cutter                                 |
| 306878      | i5100-600C-EU-LABS | BradyPrinter i5100 600 dpi - UK/EU with Cutter and Brady Workstation LAB Suite |
| 198768      | i5100-600-US       | BradyPrinter i5100 600 dpi - US  |
| 306877      | i5100-600-US-LABS  | BradyPrinter i5100 600 dpi - US with Brady Workstation LAB Suite               |
| 198769      | i5100-600-C-US     | BradyPrinter i5100 600 dpi - US with Cutter                                    |
| 306879      | i5100-600C-US-LABS | BradyPrinter i5100 600 dpi - US with Cutter and Brady Workstation LAB Suite    |

▶ The Basic Suite is included with every printer, all you need to do is download it. **Workstation.BradyID.com/Free**

For more information about the Brady Workstation Software Suites, see page 74.

#### Accessories

| Article No. | Order Ref.       | Description                                     |
|-------------|------------------|---|
| 133251      | PCK-6            | Printer Cleaning Kit, Thermal Transfer Printers |
| 149080      | BT-USB-ADAPT     | Bluetooth USB Adapter                           |
| 149131      | WLAN-EXANT       | USB Wlan Stick with External Antenna            |
| 149470      | i5100-IP-HOLDER  | RFID enabled Media Roll Holder                  |
| 149471      | i5100-PR-120mm   | i5100 120mm Platen Roller                       |
| 149472      | i5100-PR-25mm    | i5100 25mm Platen Roller                        |
| 149473      | i5100-PR-50mm    | i5100 50mm Platen Roller                        |
| 149562      | i5100-IP-RIBBTUP | Ribbon Takeup Spindle                           |
| 149598      | i5100-PR-80mm    | i5100 80mm Platen Roller                        |
| 197823      | SD-CARD-8GB      | SD Memory card 8GB                              |



#### ▶ View online

Consult the videos of the i5100 BradyPrinter on: [www.bradyeurope.com/i5100](http://www.bradyeurope.com/i5100)



## BradyPrinter i5300

### INDUSTRIAL LABEL PRINTER

**Experience easy. No setup. No adjustments. No waste.**

Set up, switch out and print faster than you ever imagined with the BradyPrinter i5300 Industrial Label Printer. It's intuitive, auto-calibrating and precise, printing barcodes and small fonts on labels as small as 5.08 mm. With a solid, metal frame construction, it can handle both high-volume and high-mix labelling applications: electronics and product ID, wire and panel ID, lab ID and safety and facility ID.

**Get fast and efficient precision printing for high-mix/high-volume labelling. Printer features quick label set up and no-waste material changeovers.**

- 300 dpi; prints small fonts with precision
- Requires no calibration and no heat and speed setting adjustments
- 20-second material changeovers, 5.08 mm – 101.6 mm label widths
- Pauses, resumes and stores print jobs on printer in an adjustable queue with overwrite protection
- 178 mm colour touchscreen and built-in auto cutter
- Solid construction with an all-metal frame
- Intuitive and easy to operate

**Easy - inside and out.**

When it comes to the BradyPrinter i5300 Industrial Label Printer, everything's easy. Taking just seconds to set up and load, it offers a faster, easier start-to-print process. That's because it's designed for efficiency - no setup, no adjustments and no waste. Zero. Enjoy time-saving features like a print queue and interrupt function. Plus, get precision printing on 75 material types and over 1300 parts, with custom parts available. All this so you can reach your high-mix, high-volume printing goals. Ready? We told you it was easy.

### Printer

| Article No. | Order Ref.        | Description   |
|-------------|-------------------|---|
| 151274      | I5300-C-EU        | i5300 Industrial Label Printer- EU  |
| 310339      | I5300-C-EU-LAB    | i5300 Industrial Label Printer- EU with Brady Workstation LAB Suite           |
| 151272      | I5300-C-NA        | i5300 Industrial Label Printer- NA  |
| 310351      | I5300-C-NA-LAB    | i5300 Industrial Label Printer- NA with Brady Workstation LAB Suite           |
| 151276      | I5300-C-UK        | i5300 Industrial Label Printer- UK  |
| 310345      | I5300-C-UK-LAB    | i5300 Industrial Label Printer- UK with Brady Workstation LAB Suite           |
| 151275      | I5300-C-EU-WF     | i5300 Industrial Label Printer with Wifi- EU                                  |
| 310340      | I5300-C-EU-WF-LAB | i5300 Industrial Label Printer with Wifi- EU with Brady Workstation LAB Suite |
| 151273      | I5300-C-NA-WF     | i5300 Industrial Label Printer with Wifi- NA                                  |
| 310352      | I5300-C-NA-WF-LAB | i5300 Industrial Label Printer with Wifi- NA with Brady Workstation LAB Suite |
| 151277      | I5300-C-UK-WF     | i5300 Industrial Label Printer with Wifi- UK                                  |
| 310346      | I5300-C-UK-WF-LAB | i5300 Industrial Label Printer with Wifi- UK with Brady Workstation LAB Suite |

This i5300 Industrial Label Printer comes in a cardboard box. It ships with a Brady WorkStation Basic Design Suite, a Power Cable, a USB Cable, a Stylus, a cleaning kit, a QuickStart Guide, a Jump drive with How To Videos and 3rd Party Win Driver.

- ▶ The Basic Suite is included with every printer, all you need to do is download it. **Workstation.BradyID.com/Free**

For more information about the Brady Workstation Software Suites, see page 74.

### Accessories

| Article No. | Order Ref.                        | Description                                     |
|-------------|-----------------------------------|---|
| 148703      | MEDIA WIPER, BBP35-37, i5300      | BBP35 and BBP37 Media Wiper                     |
| 153661      | I5300-PH-300D                     | i5300 Print Head 300 dpi                        |
| 153663      | I5300-PR-115MM                    | i5300 Print Roller                              |
| 133251      | PCK-6                             | Printer Cleaning Kit, Thermal Transfer Printers |
| 142115      | ASSY, PKG, ACCESSORY, STYLUS, PLA | Replacement Stylus 3 Pack                       |



#### ▶ View online

Learn more about the BradyPrinter i5300 on: [www.bradyeurope.com/i5300](http://www.bradyeurope.com/i5300)

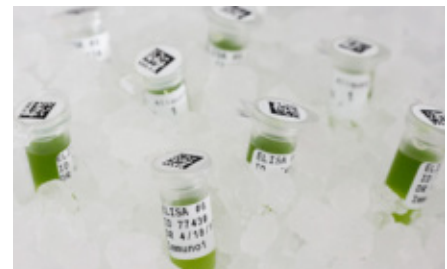



## BradyPrinter i7100

### INDUSTRIAL LABEL PRINTER

#### When accuracy meets precision

The BradyPrinter i7100 Industrial label printer offers durable and highly accurate label printing for business critical high volume identification challenges in aerospace, defence, mass transit, electronics, automotive and logistics industries. Quickly print a wide range of high quality identification materials for a variety of applications including cable, printed circuit board and asset & component identification.

#### Reliable & fast precision printing

The BradyPrinter i7100 offers highly accurate label printing for business critical high volume identification challenges.

The printer features:

- a powerful internal processor designed to handle up to 7000 labels per day
- up to 300 mm/sec print speed
- 600 dpi ultra-sharp printing
- centre alignment of prints for high printing accuracy
- interchangeable platen rollers for optimised printhead life time
- a wide range of high quality identification materials

#### Easy to use

The BradyPrinter i7100 has an intuitive colour touch screen interface with distinctive icons to easily access the printer's menus. The printer's foldable cover allows for a small system footprint and enables users to quickly change consumables to start a new job or continue printing.

#### View online

Visit [www.bradyeurope.com/i7100](http://www.bradyeurope.com/i7100) for more information on the BradyPrinter i7100.



### BradyPrinter i7100

| Article No.    | Order Reference    | Description   |
|----------------|--------------------|---|
| <b>300 dpi</b> |                    |   |
| 149046         | i7100-300-EU       | BradyPrinter i7100 300 dpi - EU   |
| 306880         | i7100-300-EU-LABS  | BradyPrinter i7100 300 dpi - EU + Brady Workstation LAB Suite                 |
| 149049         | i7100-300-P-EU     | BradyPrinter i7100 300 dpi - EU + Peel function                               |
| 306883         | i7100-300P-EU-LABS | BradyPrinter i7100 300 dpi - EU + Peel function & Brady Workstation LAB Suite |
| 149067         | i7100-300-UK       | BradyPrinter i7100 300 dpi - UK   |
| 306881         | i7100-300-UK-LABS  | BradyPrinter i7100 300 dpi - UK + Brady Workstation LAB Suite                 |
| 149068         | i7100-300-P-UK     | BradyPrinter i7100 300 dpi - UK + Peel function                               |
| 306884         | i7100-300P-UK-LABS | BradyPrinter i7100 300 dpi - UK + Peel function & Brady Workstation LAB Suite |
| 197690         | i7100-300-US       | BradyPrinter i7100 300 dpi - US   |
| 306882         | i7100-300-US-LABS  | BradyPrinter i7100 300 dpi - US + Brady Workstation LAB Suite                 |
| 197689         | i7100-300-P-US     | BradyPrinter i7100 300 dpi - US + Peel function                               |
| 306885         | i7100-300P-US-LABS | BradyPrinter i7100 300 dpi - US + Peel function & Brady Workstation LAB Suite |
| <b>600 dpi</b> |                    |   |
| 149047         | i7100-600-EU       | BradyPrinter i7100 600 dpi - EU   |
| 306886         | i7100-600-EU-LABS  | BradyPrinter i7100 600 dpi - EU + Brady Workstation LAB Suite                 |
| 149052         | i7100-600-P-EU     | BradyPrinter i7100 600 dpi - EU + Peel function                               |
| 306889         | i7100-600P-EU-LABS | BradyPrinter i7100 600 dpi - EU + Peel function & Brady Workstation LAB Suite |
| 149066         | i7100-600-UK       | BradyPrinter i7100 600 dpi - UK   |
| 306887         | i7100-600-UK-LABS  | BradyPrinter i7100 600 dpi - UK + Brady Workstation LAB Suite                 |
| 149065         | i7100-600-P-UK     | BradyPrinter i7100 600 dpi - UK + Peel function                               |
| 306890         | i7100-600P-UK-LABS | BradyPrinter i7100 600 dpi - UK + Peel function & Brady Workstation LAB Suite |
| 197692         | i7100-600-US       | BradyPrinter i7100 600 dpi - US   |
| 306888         | i7100-600-US-LABS  | BradyPrinter i7100 600 dpi - US + Brady Workstation LAB Suite                 |
| 197691         | i7100-600-P-US     | BradyPrinter i7100 600 dpi - US + Peel function                               |
| 306891         | i7100-600P-US-LABS | BradyPrinter i7100 600 dpi - US + Peel function + Brady Workstation LAB Suite |

▶ The Basic Suite is included with every printer, all you need to do is download it. [Workstation.BradyID.com/Free](http://Workstation.BradyID.com/Free)

For more information about the Brady Workstation Software Suites, see page 74.

## Vial Label Applicator

### Label vial tubes in a few seconds

Automate vial tube identification to increase the output of your laboratory. When linked to our BradyPrinter i7100, the Vial Label Applicator prints and applies labels on vial tubes in a few seconds and enables scientists to spend more time on core responsibilities.

| Art. No. | Order Reference       | Description  |
|----------|-----------------------|--|
| 307652   | i7100-300-P-EU+VLA    | BradyPrinter i7100 300 dpi - EU with Peel function and vial label applicator                                 |
| 307658   | i7100-300P-EU-LAB+VLA | BradyPrinter i7100 300 dpi - EU with Peel function and vial label applicator and Brady Workstation LAB Suite |
| 307654   | i7100-300-P-UK+VLA    | BradyPrinter i7100 300 dpi - UK with Peel function and vial label applicator                                 |
| 307660   | i7100-300P-UK-LAB+VLA | BradyPrinter i7100 300 dpi - UK with Peel function and vial label applicator and Brady Workstation LAB Suite |
| 307656   | i7100-300-P-US+VLA    | BradyPrinter i7100 300 dpi - US with Peel function and vial label applicator                                 |
| 307662   | i7100-300P-US-LAB+VLA | BradyPrinter i7100 300 dpi - US with Peel function and vial label applicator and Brady Workstation LAB Suite |
| 307653   | i7100-600-P-EU+VLA    | BradyPrinter i7100 600 dpi - EU with Peel function and vial label applicator                                 |
| 307659   | i7100-600P-EU-LAB+VLA | BradyPrinter i7100 600 dpi - EU with Peel function and vial label applicator and Brady Workstation LAB Suite |
| 307655   | i7100-600-P-UK+VLA    | BradyPrinter i7100 600 dpi - UK with Peel function and vial label applicator                                 |
| 307661   | i7100-600P-UK-LAB+VLA | BradyPrinter i7100 600 dpi - UK with Peel function and vial label applicator and Brady Workstation LAB Suite |
| 307657   | i7100-600-P-US+VLA    | BradyPrinter i7100 600 dpi - US with Peel function and vial label applicator                                 |
| 307663   | i7100-600P-US-LAB+VLA | BradyPrinter i7100 600 dpi - US with Peel function and vial label applicator and Brady Workstation LAB Suite |
| 151156   | i7100-VLA             | i7100 Vial Label Applicator  |

▶ The Basic Suite is included with every printer, all you need to do is download it. [Workstation.BradyID.com/Free](http://Workstation.BradyID.com/Free)  
For more information about the Brady Workstation Software Suites, see page 74.



## BradyPrinter i7100 accessories

| Article No. | Order Reference    | Description  |
|-------------|--------------------|--|
| 133251      | PCK-6              | Printer Cleaning Kit, Thermal Transfer Printers          |
| 149043      | i7100-PR-120mm     | 120mm Platen Roller with synthetic rubber coating        |
| 149044      | i7100-PRS-120mm    | 120mm Platen Roller with silicone rubber coating         |
| 149048      | i7100-PR-25mm      | 25mm Platen Roller with synthetic rubber coating         |
| 149051      | i7100-RAR-120mm    | 120mm Rewind Assist Roller with synthetic rubber coating |
| 149054      | i7100-PR-80mm      | 80mm Platen Roller with synthetic rubber coating         |
| 149055      | i7100-PR-50mm      | 50mm Platen Roller with synthetic rubber coating         |
| 149069      | i7100-CUTTER+TRAY  | i7100 Rotary Cutter with Tray                            |
| 149070      | i7100-ANTI-S-BRUSH | Antistatic Brush   |
| 149071      | i7100-IO-LABEL-BOX | Label Selection I/O Box                                  |
| 149072      | i7100-PS1000MP     | Present Sensor PS1000MP                                  |
| 149073      | i7100-IO-CONNECTOR | I/O Interface Connector SUB-D 25pins                     |
| 149074      | i7100-RG400-PLATE  | Rewind Guide Plate RG400                                 |
| 149075      | i7100-PS900        | Present Sensor PS900                                     |
| 149077      | i7100-IO-INTERFACE | I/O Interface  |
| 149078      | i7100-PERF-CUTTER  | i7100 Rotary Perforation Cutter                          |
| 149080      | BT-USB-ADAPT       | Bluetooth USB Adapter                                    |
| 149131      | WLAN-EXANT         | USB Wlan Stick with External Antenna                     |
| 149132      | i7100-ADAPTER-100  | i7100 Adapter for 100mm Core                             |
| 149135      | i7100-PPLTEXT-410  | i7100 Extended Peel off plate DP410                      |
| 149207      | i7100-TEAR-OFF     | i7100 Tear off Plate                                     |
| 149208      | i7100-HEX-KEY-TOOL | i7100 Spare Hex Key Tool                                 |
| 151149      | i7100-i5100-EXDISP | External display for i7100, i5100 & A8500                |
| 151150      | EXDISP-USB-1.8M    | USB cable for external display, 1,8m                     |
| 151151      | EXDISP-USB-3M      | USB cable for external display, 3m                       |
| 151152      | EXDISP-USB-5M      | USB cable for external display, 5m                       |
| 151156      | i7100-VLA          | i7100 Vial Label Applicator                              |
| 197823      | SD-CARD-8GB        | SD Memory card 8GB                                       |
| 302741      | MC11 EUR           | MC-11 Powered Label Rewinder for Europe                  |
| 302744      | LD100RS EUR        | LD-100-RS Automatic Label Dispenser for Europe           |
| 302979      | MC11 UK            | MC-11 Powered Label Rewinder for United Kingdom          |
| 302980      | LD100RS UK         | LD-100-RS Automatic Label Dispenser for United Kingdom   |

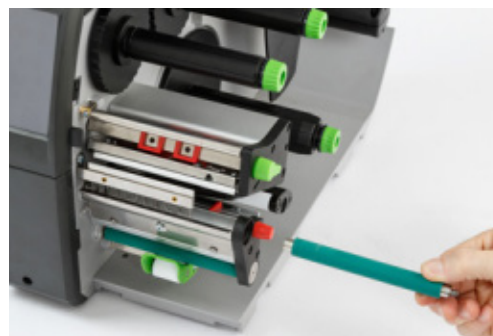

MC-11



LD-100-RS



# BradyJet J2000

## COLOUR LABEL PRINTER

The more samples laboratories need to process, the more time consuming it becomes to retrieve one specific sample. Brady Corporation proposes sample colour coding to solve this and offers the BradyJet J2000 Colour Label Printer to do it, to stay productive and to avoid spending too much time on sample hunting.

### Sort samples by colour

The BradyJet J2000 Colour Label Printer can print any colour on reliable laboratory sample labels. By setting up a colour code, laboratory specialists will be able to recognise sample categories at a glance. With over 16 million colour variations, users may switch colour every day, or use a different colour per application, storage or urgency type depending on the needs of their laboratory. Next to colour, the BradyJet J2000 also offers 4800 dpi photo quality print to add highly legible data or barcodes a decent scanner could never misread.

### Print reliable labels

The BradyJet J2000 prints on Brady's reliable laboratory sample labels that come in matching sizes and shapes for most sample containers including tubes, vials, cryo containers, dishes, plates and general glassware. These labels are designed to stay attached and to remain legible when printed with a Brady printer, even if they are stored in liquid nitrogen and in freezers, or when used in hot water baths or autoclaves. Brady's laboratory sample labels can also resist common laboratory chemicals like acetone, ethanol, toluene, xylene and IPA.

### Easy to use

With 26.4 by 38.9 cm dimensions, the BradyJet J2000 has a small footprint and is very practical and easy to use. Spring loaded Brady label rolls can be switched in less than 20 seconds and with automatic label set up, the printer is ready to print in no time. And with up to 63.5 mm per second print speed, even larger colour coded sample labels can quickly be printed on demand.

### View online

For more information or a live demo, visit [www.bradyeurope.com/J2000](http://www.bradyeurope.com/J2000)



## Printers

| Article No. | Order Ref.     | Description  |
|-------------|----------------|--|
| 150159      | J2000-EU       | BradyJet J2000 Colour Label Printer - EU                                   |
| 199966      | J2000-EU-LABS  | BradyJet J2000 Colour Label Printer - EU with Brady Workstation LAB Suite  |
| 199968      | J2000-EU-SFIDS | BradyJet J2000 Colour Label Printer - EU with Brady Workstation SFID Suite |
| 150157      | J2000-UK       | BradyJet J2000 Colour Label Printer - UK                                   |
| 199967      | J2000-UK-LABS  | BradyJet J2000 Colour Label Printer - UK with Brady Workstation LAB Suite  |
| 199969      | J2000-UK-SFIDS | BradyJet J2000 Colour Label Printer - UK with Brady Workstation SFID Suite |
| 150162      | J2000          | BradyJet J2000 Colour Label Printer - US                                   |
| 199971      | J2000-US-LABS  | BradyJet J2000 Colour Label Printer - US with Brady Workstation LAB Suite  |
| 199972      | J2000-US-SFIDS | BradyJet J2000 Colour Label Printer - US with Brady Workstation SFID Suite |

The Basic Suite is included with every printer, all you need to do is download it. [Workstation.BradyID.com/Free](http://Workstation.BradyID.com/Free)

Easily identify any sample with the most wanted laboratory sample label design apps in our Brady Workstation Lab suite.

## Accessories

| Article No. | Order Ref. | Description                        |
|-------------|------------|------------------------------------|
| 150160      | J20-CUTTER | Replacement Cutter Blade for J2000 |
| 150163      | J20-PAD    | Replacement Ink Pads for J2000     |

## Inks

| Article No. | Order Ref. | Description                                       |
|-------------|------------|---|
| 150154      | J20-CMY    | CMY pigment based ink cartridge for J2000 Printer |



## BradyJet J4000

COLOUR LABEL PRINTER

### High impact, precision full colour that lasts

Create a safer, more efficient workplace with compliant, photo-quality full-colour labels, signs and procedures that last. Balance the complexity of safety and compliance labels with the demands of an industrial environment while reducing your safety signage inventory and material waste.

**Create compliant labels and signs:** Trust your regulatory and technical standard driven labelling offers the colours needed for ISO, CLP/GHS, ANSI, BS5609 and arc flash

**Extend label performance:** Rely on specially formulated materials and ink designed to stand up to harsh environments

**Maximise impact, improve efficiency and reduce waste:** Stock and print only what you need, when you need it, in photo-quality full-colour every time



#### View online

For more information or a live demo, visit [www.bradyeurope.com/J4000](http://www.bradyeurope.com/J4000)



### Printers

| Article No. | Order Ref.      | Description  |
|-------------|-----------------|--|
| 152710      | 152710          | BradyJet J4000 Colour Label Printer                                      |
| 152711      | J4000-EU        | BradyJet J4000 Colour Label Printer                                      |
| 152712      | J4000-UK        | BradyJet J4000 Colour Label Printer                                      |
| 310390      | J4000-EU-BWLABS | BradyJet J4000 Colour Label Printer with Laboratory Software             |
| 310393      | J4000-UK-BWLABS | BradyJet J4000 Colour Label Printer with Laboratory Software             |
| 310444      | J4000-US-BWLABS | BradyJet J4000 Colour Label Printer with Laboratory Software             |
| 310388      | J4000-EU-BWSSFD | BradyJet J4000 Colour Label Printer with Safety and Facility ID Software |
| 310391      | J4000-UK-BWSSFD | BradyJet J4000 Colour Label Printer with Safety and Facility ID Software |
| 310442      | J4000-US-BWSSFD | BradyJet J4000 Colour Label Printer with Safety and Facility ID Software |

The Basic Suite is included with every printer, all you need to do is download it. [Workstation.BradyID.com/Free](http://Workstation.BradyID.com/Free)



Easily identify any sample with the most wanted laboratory sample label design apps in our Brady Workstation Lab suite.



### Ink and storage caps

| Article No. | Order Ref. | Description                              |
|-------------|------------|--|
| 152714      | J40-CMY    | BradyJet J4000 Full Colour Ink Cartridge |
| 152713      | J40-CAP    | J4000 Ink Cartridge Storage Caps         |

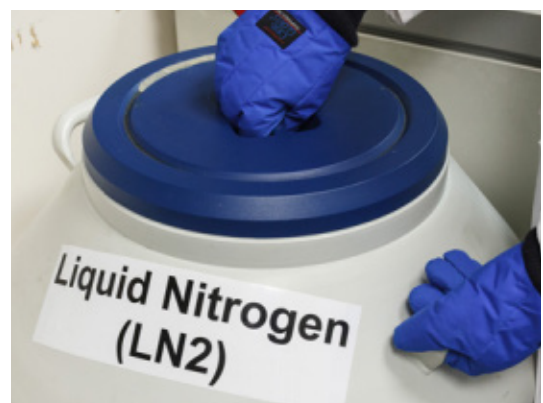

## Brady Workstation software suites

Brady Workstation offers professional, intuitive apps to design quality labels and safety signs. Label design becomes easier, faster and quickly adaptable to new label norms thanks to centralised updates.

### Select the apps you need

Simply select the apps you need, download the 30-day trial and purchase when satisfied.



#### Brady Workstation Laboratory Identification Suite

Ensure labels for all your lab samples and equipment are crisp, clear and contain all necessary information. Easily design and create labels for your cryovials, centrifuge tubes, bottles, conicals, slides and other samples in your laboratory on this desktop software.

| Article No. | Order Reference | Description  |
|-------------|-----------------|--|
| 150498      | BWS-LABS-EM     | Brady Workstation Laboratory Suite as electronic media |



#### Brady Workstation Basic Design Software Suite

Get everyone in your facility up and running quickly on as many computers as you like with this free label creation software! You'll have basic design, formatting, graphics and simple barcode libraries to create labels like a pro!

The Basic Suite is included with every printer, all you need to do is download it. **Workstation.BradyID.com/Free**

**▶ Try it today!**  
 Discover Brady Workstation at [www.bradyeurope.com/workstation](http://www.bradyeurope.com/workstation) or download at [workstation.bradyid.com](http://workstation.bradyid.com).



#### Brady Workstation Safety and Facility Identification Software Suite

Keep your facility safe and compliant by creating custom signs, label and pipemarkers, adding visual safety guidance. **Workstation.BradyID.com/SafetyAndFacility**



#### Brady Workstation Data Automation

Use the Brady Workstation Data Automation app to set up automated sample label printing using information from a LIMS. Data Automation uses Brady Workstation label templates and .csv – exports from an ERP system such as LIMS. It enables the setup of several print channels that send preselected information to a predetermined label template which can be printed on a printer of choice, loaded with the correct consumables. Once set up, Data Automation can automatically print a sample label when a LIMS receives information on a newly arrived sample.



#### Brady Workstation Express Labels Mobile App

The Brady Workstation Express Labels Mobile App makes mobile printing convenient and simple. This intuitively designed software integrates touchscreen technology for fast and easy label creation, including label resizing using touch and a native keyboard for more natural typing. To make label creation even more convenient, the app features auto-save capabilities, tools to help you easily enter data onto your label, and easy-to-use editing tools to keep labelling projects moving smoothly.



## CodeSoft™ Label Creation Software

CodeSoft is a very powerful, feature-rich design software. It has the most text editing and bar code features, plus it is the best choice for advanced database importation and integration with 3rd party software programs - like LIMS.

- Over 100 Bar code symbologies including linear and 2D
- Robust data sourcing capabilities
- View labels and data in the same screen
- Label Comparison tool for previewing labels at design or production stages
- OLE automation supports object integration from any 3rd party Windows® application
- Enhanced Shape Tool makes using graphics and shapes on your labels a snap
- **CodeSoft Pro** - is for users printing text, images and bar codes on one to three printers
- **CodeSoft Enterprise** - is for user printing from databases and existing systems
- **CodeSoft Network** - is for users who want to manage licenses from a server

Brady offers a range of easy-to-use, high density scanners with superior imaging technology (Adaptus) that enable :

- fast and efficient scanning of any barcode, 2D-code or QR-code on a range of surfaces
- optimal handling thanks to a light weight and small size
- durable and reliable, stays intact in drop tests when falling from up to 1.8 m.







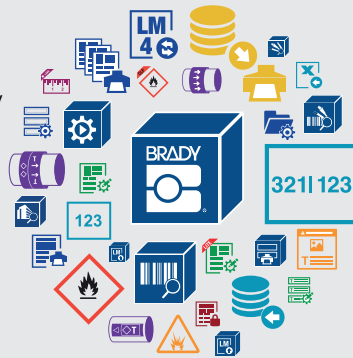

## Brady Workstation

In order to achieve full track & trace control, you can use Brady Workstation apps to quickly design labels, import data from ERP or LIMS-systems, add QR-codes, barcodes or other 2D-codes, serialise and hit print. When printed with the specialised inks of a Brady printer, our label materials can identify items throughout complete production cycles and in storage much more effectively and much longer than any non-specialised solution.



## Linear vs. 2-Dimensional Bar Codes

| 7 mil Examples   | 10 mil Examples  | Symbol Size (mm)<br>Row x Column | Bar Code Data Capacity<br>Numeric | Bar Code Data Capacity<br>Alphanumeric | Built-in Error Correction |
|--|--|----------------------------------|-----------------------------------|--|---------------------------|
| <br>3.43 mm / 2D / Data Matrix Bar Code   | <br>4.57 mm / 2D / Data Matrix Bar Code   | 18 x 18                          | 36                                | 25                                     | YES (ECC200)              |
| <br>4.95 mm / 2D / Data Matrix Bar Code   | <br>6.60 mm / 2D / Data Matrix Bar Code   | 26 x 26                          | 88                                | 64                                     | YES (ECC200)              |
| <br>25.40 mm / Linear / Code 128 Bar Code | <br>31.75 mm / Linear / Code 128 Bar Code | 31.75                            | 10                                | 10                                     | NO                        |

## Honeywell Voyager 1470G 2D

Optimised for fast scanning of linear bar codes, including poorly printed and damaged codes, the Voyager 1470g2D enables enterprises to minimise manual data entry, leading to increased productivity and reduction in errors.

- 1D barcodes
- Laser technology
- Read barcodes up to 40 cm away
- Ergonomic design
- IP40 rated



| Article No. | Description                                 |
|-------------|---|
| 306804      | Honeywell Voyager 1470G 2D handheld scanner |



## Honeywell Enhanced Xenon 1950H HD

The Xenon 1950H HD scanner delivers superior barcode scanning and digital image capture. The scanner incorporates a revolutionary decoding architecture and a custom sensor, enabling extended depth of field, faster reading and improved scanning performance on poor-quality barcodes. From highdensity linear to 2D barcodes found directly on the screen of a mobile device, the 1950H HD scanner decodes virtually all barcodes with ease.

| Article No. | Description   |
|-------------|---|
| 306801      | Honeywell Enhanced Xenon 1950H HD handheld healthcare scanner |



## Honeywell Enhanced Xenon 1952H HD

The wireless area-imaging scanner Xenon 1952H HD delivers superior bar code scanning and digital image capture. Xenon 1952H HD incorporates a revolutionary decoding architecture and a custom sensor, enabling extended depth of field, faster reading, and improved scanning performance on poor quality bar codes. From high density linear to 2D bar codes found directly on the screen of a mobile device, Xenon 1952H HD decodes virtually all bar codes with ease. Xenon 1952H HD incorporates a Bluetooth Class 2, v2.1 radio, enabling unrestricted movement up to 10m from the base, and a battery that provides up to 14 hours of battery life. For added convenience, a paging system helps locate misplaced scanners.

| Article No. | Description   |
|-------------|---|
| 306803      | Honeywell Enhanced Xenon 1952H HD bluetooth scanner |

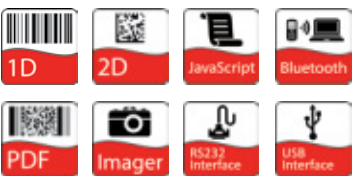

The Code Reader scanners are still available. Contact your local Brady distributor or Brady customer service for ordering information.



## Miscellaneous Products

- 78 Hazardous Substance Identification
- 81 Sorbent Products
- 83 Pipemarkers
- 83 Safety Signs on Rolls



## All Chemicals Labelled?

CLP is a mandatory European Union regulation which requires, amongst other obligations, the clear identification of products containing dangerous chemicals.

The EU's CLP regulation is based on the United Nation's Globally Harmonised System for chemical substances and, from June 2015 onwards, compliance to CLP is required for dangerous chemicals and mixtures in all EU member states. Every substance listed as dangerous, and every mix containing one of these dangerous substances, also needs to carry a CLP label as of June 2015.



## What is CLP?

**Classification, Labelling and Packaging (CLP) of substances and mixtures is the EU Regulation 1272/2008 which is an EU-wide system for classifying and labelling chemicals.**

**The system adopts the United Nations' Globally Harmonised System, or GHS.**

- The GHS/CLP symbols were introduced in the EU on the basis of the CLP/GHS regulation (Classification, Labelling and Packaging) in January 2009.
- **GHS/CLP replaces the HSID labelling:** The orange coloured hazardous materials pictograms used until now are being replaced with new diamond-shaped pictograms on a white background with a red border. The current R+S Statements are replaced by H+P Statements (+ EUH Statements). In the EU, it has been required since 01.12.2010 to label **chemical substances** in accordance with the regulation. As from 01.06.2015 this requirement also applies to **chemical mixtures**. In the CLP/GHS the signal words "Danger and "Warning must be used, in accordance with the substance.

## Why does GHS matter?

**Chemical import/export means big business**

Globally, the production and use of chemicals is a more than 1.5 trillion € per year enterprise (340€ billion in the U.S. alone). Chemical labelling has appeared differently based on different regional requirements. With such an impact on the world economy, it's critical that the import and export of chemicals be made as safe and efficient as possible.

The GHS standard globally helps keep workers safe and informed of chemical hazards.

## Pre-Printed Labels with CLP/GHS Symbols

**Brady has a wide range of pre-printed labels to identify your chemical containers.**

- High quality labels that can withstand the toughest environments
- Ultra-durable materials mean you only need to label products once in their lifetime
- Extremely weather, abrasion and chemical resistant
- Labels can withstand temperatures of -40 °C to +120 °C

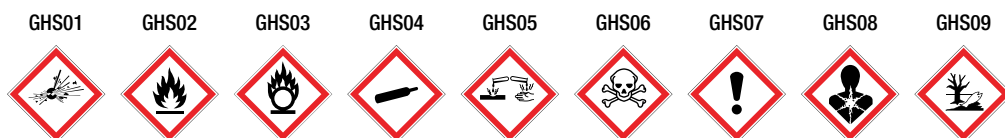

| Width x Height  | Layout                       | PIC 1801  | PIC 1802  | PIC 1803  | PIC 1804       | PIC 1808  | PIC 1809       | PIC 1805      | PIC 1807           | PIC 1806                         |
|-----------------|------------------------------|-----------|-----------|-----------|----------------|-----------|----------------|---------------|--------------------|----------------------------------|
|                 |                              | Explosive | Flammable | Oxidizing | Compressed Gas | Corrosive | Acute Toxicity | Health Hazard | Respiratory Hazard | Hazardous to Aquatic Environment |
| 50 mm x 50 mm   | Continuous Roll              | 811681    | 811686    | 811691    | 811696         | 811716    | 811721         | 811701        | 811711             | 811706                           |
| 50 mm x 50 mm   | Individual Markers on a Roll | 814032    | 814033    | 814034    | 814035         | 814039    | 814040         | 814036        | 814038             | 814037                           |
| 100 mm x 100 mm | Continuous Roll              | 814023    | 814024    | 814025    | 814026         | 814030    | 814031         | 814027        | 814029             | 814028                           |
| 100 mm x 100 mm | Individual Markers on a Roll | 811679    | 811684    | 811689    | 811694         | 811714    | 811719         | 811699        | 811709             | 811704                           |

## Pre-printed GHS/CLP Chemical Labels

Print 2 colour GHS labels in one fast print pass!

- Blank labels with pre-printed red diamonds allow printer to produce 2 colour GHS/CLP labels in one print pass
- 3 sizes of labels, each with 6 different diamond layouts that match templates in Brady Workstation. Visit [www.bradyeurope.com](http://www.bradyeurope.com) or contact your Brady distributor for more information



### Pre-printed GHS/CLP Labels for BBP12 Label Printer

| Diagram                      | Order Reference          | Layout | Label Width A (mm) | Label Height B (mm) | Vertical Repeat D (mm) | Web Width E (mm) | Labels per Row | Labels per Package | Ribbon Series |
|------------------------------|--------------------------|--------|--------------------|---------------------|------------------------|------------------|----------------|--------------------|---------------|
| <b>B-7610: Paper</b>         |                          |        |                    |                     |                        |                  |                |                    |               |
| ▲                            | THTCLP-S-L1-7610-0.4-SC  | L1     | 55.00              | 85.00               | 91.02                  | 59.00            | 1              | 400                | R7950         |
| ▲                            | THTCLP-S-L3A-7610-0.4-SC | L3A    | 55.00              | 85.00               | 91.02                  | 59.00            | 1              | 400                | R7950         |
| ▲                            | THTCLP-S-L4A-7610-0.4-SC | L4A    | 55.00              | 85.00               | 91.02                  | 59.00            | 1              | 400                | R7950         |
| ▲                            | THTCLP-S-L4B-7610-0.4-SC | L4B    | 55.00              | 85.00               | 91.02                  | 59.00            | 1              | 400                | R7950         |
| ▲                            | THTCLP-M-L3A-7610-0.3-SC | L3A    | 75.00              | 110.00              | 115.36                 | 79.00            | 1              | 300                | R7950         |
| ▲                            | THTCLP-M-L4B-7610-0.3-SC | L4B    | 75.00              | 110.00              | 115.36                 | 79.00            | 1              | 300                | R7950         |
| ▲                            | THTCLP-L-L2-7610-0.2-SC  | L2     | 105.00             | 155.00              | 160.12                 | 109.00           | 1              | 200                | R7950         |
| ▲                            | THTCLP-L-L3A-7610-0.2-SC | L3A    | 105.00             | 155.00              | 160.12                 | 109.00           | 1              | 200                | R7950         |
| ▲                            | THTCLP-L-L3B-7610-0.2-SC | L3B    | 105.00             | 155.00              | 160.12                 | 109.00           | 1              | 200                | R7950         |
| <b>B-7594: Polypropylene</b> |                          |        |                    |                     |                        |                  |                |                    |               |
| ▲                            | THTCLP-S-L1-7594-0.4-SC  | L1     | 55.00              | 85.00               | 91.02                  | 59.00            | 1              | 400                | R6000HF       |
| ▲                            | THTCLP-S-L2-7594-0.4-SC  | L2     | 55.00              | 85.00               | 91.02                  | 59.00            | 1              | 400                | R6000HF       |
| ▲                            | THTCLP-S-L3A-7594-0.4-SC | L3A    | 55.00              | 85.00               | 91.02                  | 59.00            | 1              | 400                | R6000HF       |
| ▲                            | THTCLP-S-L3B-7594-0.4-SC | L3B    | 55.00              | 85.00               | 91.02                  | 59.00            | 1              | 400                | R6000HF       |
| ▲                            | THTCLP-S-L4A-7594-0.4-SC | L4A    | 55.00              | 85.00               | 91.02                  | 59.00            | 1              | 400                | R6000HF       |
| ▲                            | THTCLP-S-L4B-7594-0.4-SC | L4B    | 55.00              | 85.00               | 91.02                  | 59.00            | 1              | 400                | R6000HF       |
| ▲                            | THTCLP-M-L1-7594-0.3-SC  | L1     | 75.00              | 110.00              | 115.36                 | 79.00            | 1              | 300                | R6000HF       |
| ▲                            | THTCLP-M-L2-7594-0.3-SC  | L2     | 75.00              | 110.00              | 115.36                 | 79.00            | 1              | 300                | R6000HF       |
| ▲                            | THTCLP-M-L3A-7594-0.3-SC | L3A    | 75.00              | 110.00              | 115.36                 | 79.00            | 1              | 300                | R6000HF       |
| ▲                            | THTCLP-M-L3B-7594-0.3-SC | L3B    | 75.00              | 110.00              | 115.36                 | 79.00            | 1              | 300                | R6000HF       |
| ▲                            | THTCLP-M-L4A-7594-0.3-SC | L4A    | 75.00              | 110.00              | 115.36                 | 79.00            | 1              | 300                | R6000HF       |
| ▲                            | THTCLP-M-L4B-7594-0.3-SC | L4B    | 75.00              | 110.00              | 115.36                 | 79.00            | 1              | 300                | R6000HF       |
| ▲                            | THTCLP-L-L1-7594-0.2-SC  | L1     | 105.00             | 155.00              | 160.12                 | 109.00           | 1              | 200                | R6000HF       |
| ▲                            | THTCLP-L-L2-7594-0.2-SC  | L2     | 105.00             | 155.00              | 160.12                 | 109.00           | 1              | 200                | R6000HF       |
| ▲                            | THTCLP-L-L3A-7594-0.2-SC | L3A    | 105.00             | 155.00              | 160.12                 | 109.00           | 1              | 200                | R6000HF       |
| ▲                            | THTCLP-L-L3B-7594-0.2-SC | L3B    | 105.00             | 155.00              | 160.12                 | 109.00           | 1              | 200                | R6000HF       |
| ▲                            | THTCLP-L-L4B-7594-0.2-SC | L4B    | 105.00             | 155.00              | 160.12                 | 109.00           | 1              | 200                | R6000HF       |

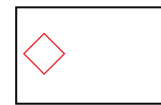
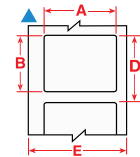

L1

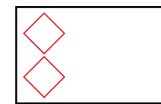

L2

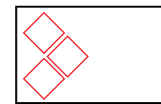

L3A

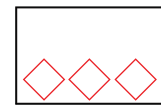

L3B

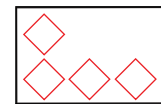

L4A

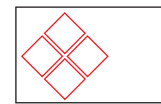

L4B

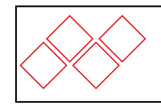

L4C

### Pre-printed GHS/CLP Labels for i3300 Label Printer

| Diagram              | Order Reference    | Layout | Label Width A (mm) | Label Height B (mm) | Labels per Row | Labels per Package | Ribbon Series |
|----------------------|--------------------|--------|--------------------|---------------------|----------------|--------------------|---------------|
| <b>B-7569: Vinyl</b> |                    |        |                    |                     |                |                    |               |
| ▲                    | B30-18-7569-CLP4C  | L4C    | 76.20              | 25.40               | 1              | 1000               | B30-R10000    |
| ▲                    | B30-260-7569-CLP1  | L1     | 85.00              | 55.00               | 1              | 340                | B30-R10000    |
| ▲                    | B30-260-7569-CLP2  | L2     | 85.00              | 55.00               | 1              | 340                | B30-R10000    |
| ▲                    | B30-260-7569-CLP3A | L3A    | 85.00              | 55.00               | 1              | 340                | B30-R10000    |
| ▲                    | B30-260-7569-CLP3B | L3B    | 85.00              | 55.00               | 1              | 340                | B30-R10000    |
| ▲                    | B30-260-7569-CLP4A | L4A    | 85.00              | 55.00               | 1              | 340                | B30-R10000    |
| ▲                    | B30-260-7569-CLP4B | L4B    | 85.00              | 55.00               | 1              | 340                | B30-R10000    |
| ▲                    | B30-261-7569-CLP1  | L1     | 110.00             | 75.00               | 1              | 270                | B30-R10000    |
| ▲                    | B30-261-7569-CLP2  | L2     | 110.00             | 75.00               | 1              | 270                | B30-R10000    |
| ▲                    | B30-261-7569-CLP3A | L3A    | 110.00             | 75.00               | 1              | 270                | B30-R10000    |
| ▲                    | B30-261-7569-CLP3B | L3B    | 110.00             | 75.00               | 1              | 270                | B30-R10000    |
| ▲                    | B30-261-7569-CLP4A | L4A    | 110.00             | 75.00               | 1              | 270                | B30-R10000    |
| ▲                    | B30-261-7569-CLP4B | L4B    | 110.00             | 75.00               | 1              | 270                | B30-R10000    |
| ▲                    | B30-262-7569-CLP1  | L1     | 155.00             | 105.00              | 1              | 200                | B30-R10000    |
| ▲                    | B30-262-7569-CLP2  | L2     | 155.00             | 105.00              | 1              | 200                | B30-R10000    |
| ▲                    | B30-262-7569-CLP3A | L3A    | 155.00             | 105.00              | 1              | 200                | B30-R10000    |
| ▲                    | B30-262-7569-CLP3B | L3B    | 155.00             | 105.00              | 1              | 200                | B30-R10000    |
| ▲                    | B30-262-7569-CLP4A | L4A    | 155.00             | 105.00              | 1              | 200                | B30-R10000    |
| ▲                    | B30-262-7569-CLP4B | L4B    | 155.00             | 105.00              | 1              | 200                | B30-R10000    |

# Hazardous Substance Identification



## Quickly print GHS/CLP-labels

The BradyJet J2000 and BradyJet J4000 colour label printers take printing reliable GHS/CLP labels at your location to a new level. The printers' advanced full colour inkjet technology can quickly turn a range of blank label materials and label sizes into compliant GHS/CLP labels to identify chemicals. With their automatic label setup technology, these printers can start printing on a new label size within seconds, saving you time, stress and hassle.

## Extremely reliable

Brady proposes B-7425J polypropylene and B-2595 vinyl label materials to print GHS/CLP labels. Both label materials remain legible and stay attached when exposed to chemicals.

## BradyJet J2000 labels

| Diagram                               | Order Reference | Art. No. | Colour | Label Width A (mm) | Label Height B (mm) | Label Length B (m) | Total Qty/ Pack |
|---------------------------------------|-----------------|----------|--------|--------------------|---------------------|--------------------|-----------------|
| <b>Inkjet Receptive Polypropylene</b> |                 |          |        |                    |                     |                    |                 |
| ∞                                     | J20C-1125-7425J | 150542   | White  | 28.58              | –                   | 30.48 m            | 1               |
| ∞                                     | J20C-2250-7425J | 150547   | White  | 57.15              | –                   | 30.48 m            | 1               |
| ▲                                     | J20-18-7425J    | 150545   | White  | 76.20              | 25.40               | -                  | 1000            |
| ▲                                     | J20-260-7425J   | 150543   | White  | 55.00              | 85.00               | -                  | 340             |
| ▲                                     | J20-261-7425J   | 150541   | White  | 75.00              | 109.98              | -                  | 270             |
| ▲                                     | J20-262-7425J   | 150544   | White  | 105.00             | 155.00              | -                  | 200             |
| <b>Inkjet Receptive Vinyl</b>         |                 |          |        |                    |                     |                    |                 |
| ∞                                     | J20C-1125-2595  | 150010   | White  | 28.58              | –                   | 30.48 m            | 1               |
| ∞                                     | J20C-2250-2595  | 150014   | White  | 57.15              | –                   | 30.48 m            | 1               |
| ∞                                     | J20C-4000-2595  | 150017   | White  | 101.60             | –                   | 30.48 m            | 1               |
| ▲                                     | J20-18-2595     | 150546   | White  | 76.20              | 25.40               | -                  | 1000            |
| ▲                                     | J20-260-2595    | 150013   | White  | 55.00              | 85.00               | -                  | 340             |
| ▲                                     | J20-261-2595    | 150027   | White  | 75.00              | 110.00              | -                  | 270             |
| ▲                                     | J20-262-2595    | 150032   | White  | 105.00             | 155.00              | -                  | 200             |

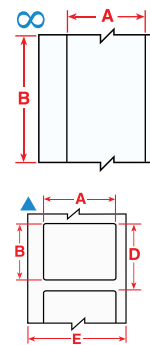

## BradyJet J4000 labels

| Diagram                               | Order Reference | Art. No. | Colour | Label Width A (mm) | Label Height B (mm) | Label Length B (m) | Total Qty/ Pack |
|---------------------------------------|-----------------|----------|--------|--------------------|---------------------|--------------------|-----------------|
| <b>Inkjet Receptive Polypropylene</b> |                 |          |        |                    |                     |                    |                 |
| ∞                                     | J40C-2250-7425J | 152783   | White  | 57.15              | –                   | 30.48 m            | 1               |
| ∞                                     | J40C-4000-7425J | 152784   | White  | 101.60             | –                   | 30.48 m            | 1               |
| ∞                                     | J40C-6000-7425J | 152785   | White  | 152.40             | –                   | 30.48 m            | 1               |
| ∞                                     | J40C-8000-7425J | 152786   | White  | 203.20             | –                   | 30.48 m            | 1               |
| ▲                                     | J40-260-7425J   | 152778   | White  | 55.00              | 85.00               | -                  | 340             |
| ▲                                     | J40-321-2475J   | 152781   | White  | 203.20             | 133.35              | -                  | 100             |
| ▲                                     | J40-262-7425J   | 152779   | White  | 104.90             | 155.00              | -                  | 200             |
| ▲                                     | J40-265-7425J   | 152780   | White  | 177.80             | 254.00              | -                  | 100             |
| ▲                                     | J40-268-2475J   | 152782   | White  | 203.20             | 279.40              | -                  | 100             |

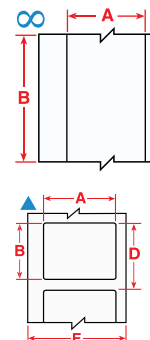



## Lab Pack

- Ideal for medium sized spills.
- Water and chemical resistant drum protects sorbents.
- Easy access to products thanks to screw top lid.
- Drum can be used as shipping container for used sorbents.

**Kit contains:** 12 pads (40 cm x 50 cm), 3 socs (7.6 diam cm x 366 cm), 2 pillows (43 cm x 48 cm), 1 pair of gloves, 1 pair of goggles and 3 disposal bags

| Order Reference | Article No. | Description           | Quantity | Absorption Capacity (Ltrs) |
|-----------------|-------------|-----------------------|----------|----------------------------|
| SKO-20          | 813869      | LAB PACK, Oil Only    | 1 Kit    | 57                         |
| SKA-20          | 813870      | LAB PACK, Maintenance | 1 Kit    | 56                         |
| SKH-20          | 813871      | LAB PACK, Chemical    | 1 Kit    | 56                         |



## SPC Spill Box

Pads in a convenient dispenser box allowing you to create multiple spill stations around your site!

- Reusable plastic box can be refilled once all the sorbents have been used.
- The Spill Box is light enough to be hung to laboratory and storage area walls or to be attached to a forklift.
- The bright yellow colour stands out for quick identification and use.
- Various application areas: in liquid storage areas, behind the seat of a truck, lab environments, in workstations that deal with liquids.

| Order Reference | Article No. | Description                                     | Total Qty/Pack  |
|-----------------|-------------|---|-----------------|
| SA-SBA          | 813909      | SPILL BOX, Maintenance, filled box with 15 pads | 15 Pad(s) / Kit |
| SA-SBH          | 813910      | SPILL BOX, Chemical, filled box with 10 pads    | 10 Pad(s) / Box |



## Spill Response Plus

Spill Response Plus is a smaller size pad and roll designed to be highly absorbent, durable, low lint and to reduce waste.

- Dimpled design provides better looking, strong and durable product
- Roll is perforated so you only use what you need
- Includes universal (grey) and chemical (green) applications
- **Perfect to be used with Spill Safety Stations**

| Order Reference | Article No. | Description  | Colour | Total Qty/ Pack | Absorption Capacity (Ltrs) |
|-----------------|-------------|--|--------|-----------------|----------------------------|
| MRO365-P        | 834176      | ROLL, 19 cm x 15 m, Heavyweight, perforated & bonded, 60 pads per roll         | Grey   | 1 Roll(s) / Bag | 15                         |
| UN295-P         | 834177      | ROLL, Medium weight, double perforated & bonded 19 cm x 15 m, 60 pads per roll | Green  | 1 Roll(s) / Bag | 13                         |



## SKH-Mini

A fully disposable spill kit to clean up small chemical spills easily and without risk of injuries.

- The autoclavable disposal bag is heat resistant up to 145°C to guarantee safe disposal of laboratory waste.
- Suited for spills of up to 1.7 litres, absorbing chemicals, water & oil based fluids.
- The specially designed disposable brush is intended to sweep up any broken glass or debris allowing a safe clean up without risk of injuries.
- Compact design: the SKH-MINI can easily be placed in any areas where it is most needed.
- Protective gloves are powder free, have roughened fingertips, increased tear resistance and a good chemical resistance for more safety.

**Contents:** 2 pads (40 cm x 50 cm), 1 pair of disposable chemical protective gloves, 1 autoclavable disposal bag, 1 disposable brush, and multilingual instruction guide

| Order Reference | Article No. | Description                    | Quantity   | Absorption Capacity (Ltrs) |
|-----------------|-------------|--------------------------------|------------|----------------------------|
| SKH-MINI        | 813868      | Disposable spill kit, chemical | 4 Kits/Box | 7.00                       |

\*4 x 1.7 litres





## UN Pads & Rolls

**For use when chemicals and hazardous liquids are involved!**

- Chemically inert: product does not degrade or cause a dangerous chemical reaction with the adsorbed liquid.
- One-sided spunbond gives extra strength as well as lower lint.
- Perforated for flexibility – tear at the perforations for smaller sized pads to use only what you need.

### Pads

| Order Reference | Article No. | Description  | Total Qty/Pack             | Absorption Capacity (Ltrs) |
|-----------------|-------------|--|----------------------------|----------------------------|
| UN100-E         | 813842      | PADS, 40 cm x 50 cm, Medium weight, perforated & bonded                | 100 Pad(s) / Box           | 87                         |
| UN1212-E        | 813843      | PAD, Medium weight, bonded 30 cm x 30 cm, 50 pads/Bag, 4 Bags/disp.box | 200 Pad(s) / Dispenser Box | 80                         |

### Rolls

| Order Reference | Article No. | Description  | Total Qty/Pack   | Absorption Capacity (Ltrs) |
|-----------------|-------------|--|------------------|----------------------------|
| UN15-2DP-E      | 813844      | ROLL, Medium weight, double perforated & bonded 38 cm x 46 m                   | 2 Roll(s) / Pack | 155                        |
| UN15-DP-E       | 813845      | ROLL, Medium weight, double perforated & bonded 38 cm x 46 m                   | 1 Roll(s) / Box  | 78                         |
| UN15-DPS-E      | 813846      | ROLL, Medium weight, double perforated & bonded 38 cm x 23 m                   | 1 Roll(s) / Box  | 39                         |
| UN30-DP-E       | 813847      | ROLL, Medium weight, double perforated & bonded 76 cm x 46 m                   | 1 Roll(s) / Box  | 155                        |
| UN295-P         | 834177      | ROLL, Medium weight, double perforated & bonded 19 cm x 15 m, 60 pads per roll | 1 Roll(s) / Bag  | 13                         |



## SPC - Sorbent Products

Your partner in helping your business guard against the leaks, drips and spills that create safety and environmental hazards in the workplace with quality sorbent products.

**Contact your Brady Distributor to receive a copy of the SPC catalogue**

## Pipemarkers

- This pipemarker dimension (12 x 150 mm) has been specially developed by Brady for the identification of small pipes.
- Ideal for marking Piped Medical Gases, these markers are made from thin, flexible polyester (B-7541)
- For Pipes with a diameter from 6 to 20mm
- Sold by the card, with 5 markers per card
- Many legends available - please visit [www.bradyeurope.com](http://www.bradyeurope.com) for full listing

| Label Width<br>A (mm) | Label Height<br>B (mm) | Letter height (mm) | Total Qty/Pack     |
|-----------------------|------------------------|--------------------|--------------------|
| 150.00                | 12.00                  | 6.50               | 5 Marker(s) / Card |



## Safety Signs on Rolls

- Material: Laminated Polyester
- Number of signs per roll: 250
- Available Sizes: Triangular with sides of 25, 50 or 100 mm
- Labels are supplied die-cut to a triangular shape



| Width (mm) | W016   | W023   | W003   | W009   |
|------------|--------|--------|--------|--------|
| 25 mm      | 828682 | 829718 | 826758 | 827646 |
| 50 mm      | 828684 | 829720 | 826760 | 827648 |
| 100 mm     | 828686 | 829722 | 826762 | 827650 |



Contact your Brady Distributor to receive a copy of Brady's Pipe Marking and Safety Signs brochures.



**Africa**

Randburg, South Africa  
Tel.: +27 11 704 3295  
Email: africa@bradycorp.com

**Benelux**

Zele, Belgium  
Tel.: +32 (0) 52 45 78 11  
Email: benelux@bradycorp.com

**Central & Eastern Europe**

Bratislava, Slovakia  
Tel.: +421 2 3300 4800  
Email: central\_europe@bradycorp.com

**Denmark**

Odense  
Tel.: +45 66 14 44 00  
Email: denmark@bradycorp.com

**France**

Roncq  
Tel.: +33 (0) 3 20 76 94 48  
Email: france@bradycorp.com

**Germany, Austria & Switzerland**

Egelsbach, Germany  
Tel.: +49 (0) 6103 7598 660  
Email: germany@bradycorp.com

**Hungary**

Budaörs  
Tel.: +36 23 500 275  
Email: central\_europe@bradycorp.com

**Italy**

Gorgonzola  
Tel.: +39 02 26 00 00 22  
Email: italy@bradycorp.com

**Middle East FZE**

Dubai, UAE  
Tel.: +971 4881 2524  
Email: me@bradycorp.com

**Norway**

Kjeller  
Tel.: +47 70 13 40 00  
Email: norway@bradycorp.com

**Spain & Portugal**

Madrid, Spain  
Tel.: +34 900 902 993  
Email: spain@bradycorp.com,  
portugal@bradycorp.com

**Sweden, Finland, Baltic states**

Kista, Sweden  
Tel.: +46 (0) 8 590 057 30  
Email: sweden@bradyeurope.com

**Turkey**

Istanbul  
Tel.: +90 212 264 02 20 / 264 02 21  
Email: turkey@bradycorp.com

**UK & Ireland**

Banbury, UK  
Tel.: +44 (0) 1295 228 288  
Email: uk@bradycorp.com

Our mission is to identify and protect people, products and premises



To help minimise our impact on the environment, Brady limits its number of reprints.

Updated versions are always available for download on [www.bradyeurope.com](http://www.bradyeurope.com).



Search for: EUR-M-513-EN



Y1455478

Your distributor

31/03/2023